



KINGPAR 5

SLI-KINGPAR5

.....

- Kingpar 5 1 .
- 1 .
- 1 .

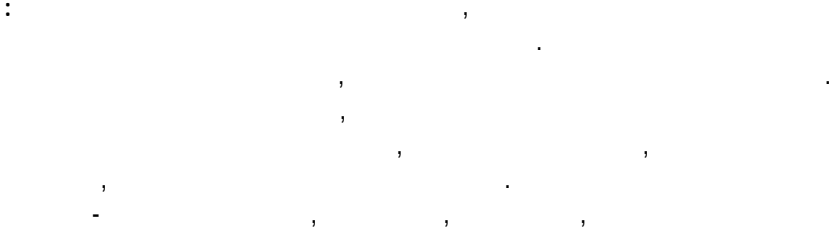

DMX, master/slave (/).

master/slave.

!

!

!

.....

- : 100 ~240 , 50 ~60
- : 73
- : 6 , , 12 .
- : 25°
- : IP20
- DMX : 5
- : 300* 300 * 380
- : 3,1
- : 4,53

- DMX XLR
- IEC
- LCD
- -20°C~+40°C
- /

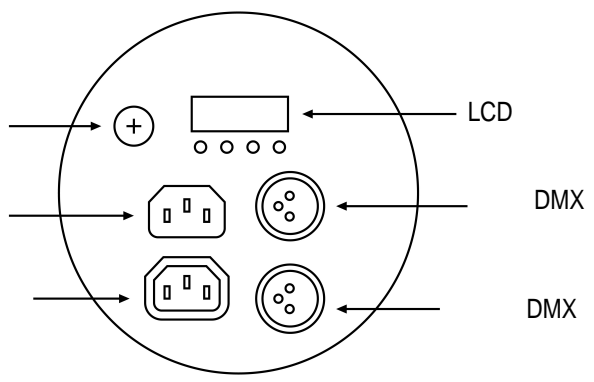

.....



1.

2.

3.

0,5

4.

5.

		3
		2
/		1

DMX 512

XLR DMX512 (1, 2, 3). Input () Output ()
100 . ,

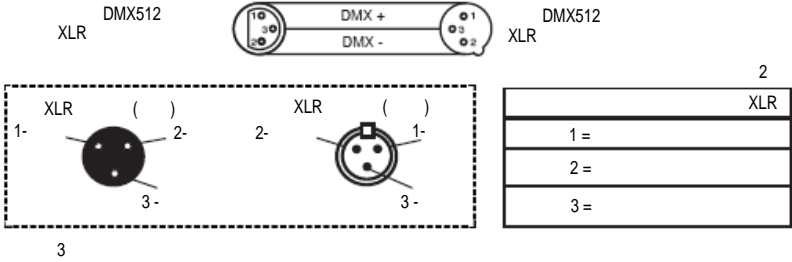

MENU ()	
ENTER ()	
UP ()	
DOWN ()	

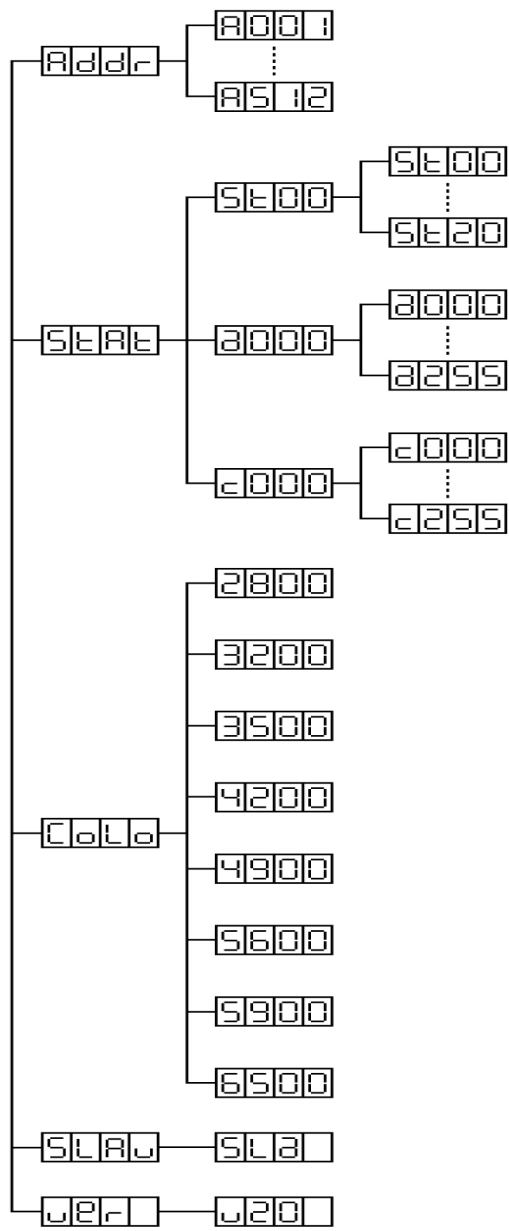

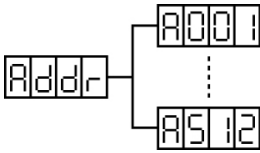

- [DMX]
- MENU, Up DOWN, "Addr", ENTER
- C UP DOWN DMX . ENTER
- DMX .

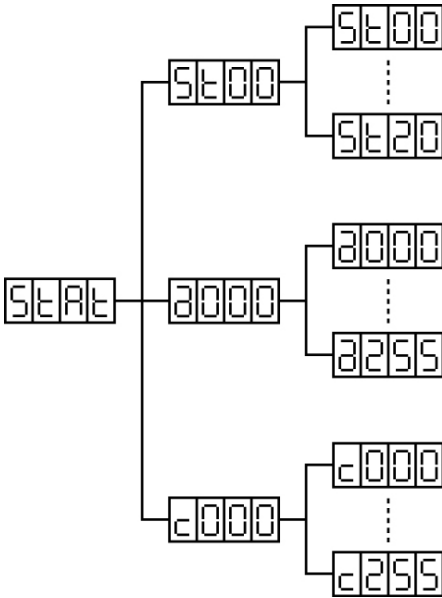

- []
- MENU, Up DOWN, "STAT", ENTER.
- C UP DOWN ST00(), a000(), C000 ().

ENTER,
MENU

UP DOWN,

ENTER
UP DOWN

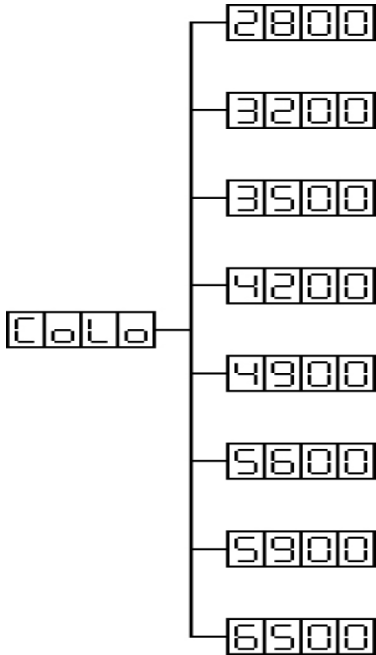

- []
- MENU, Up DOWN, "CoLo", ENTER.
 - UP DOWN - 2800K, 3200K, 3500K, 4200K, 4900K, 5600K, 5900K, 6500K.

SLAW — SL2

[SLAVE]
 • MENU, Up DOWN, "SLAv", ENTER. "Sla",



[]
 • MENU, Up DOWN, "vEr", ENTER.

DMX

ch1	0--255	dimmer (0%--100%)
ch2	0--255	Warm white (0%--100%)
ch3	0--255	Cool white (0%--100%)
ch4	0--255	Strobe () 0-20 (-)
Ch5	0--15	
	16--44	2800K
	45--74	3200K
	75-104	3500K
	105-134	4200K
	135-164	4900K
	165-194	5600K
	195-224	5900K
	225-255	6500K

.....

1. CE
EMC (2004/108/CE), CE (93/68/EEC)
(2006/95/EC).
2. « » WEEE (
) (2002/96/EC).
3. «RoHS compliant» (2002/95EC)

24-10-2012

/

