

Roland

PROGRAMMABLE SYNTHESIZER

JD-800

Owner's Manual II
(REFERENCE)

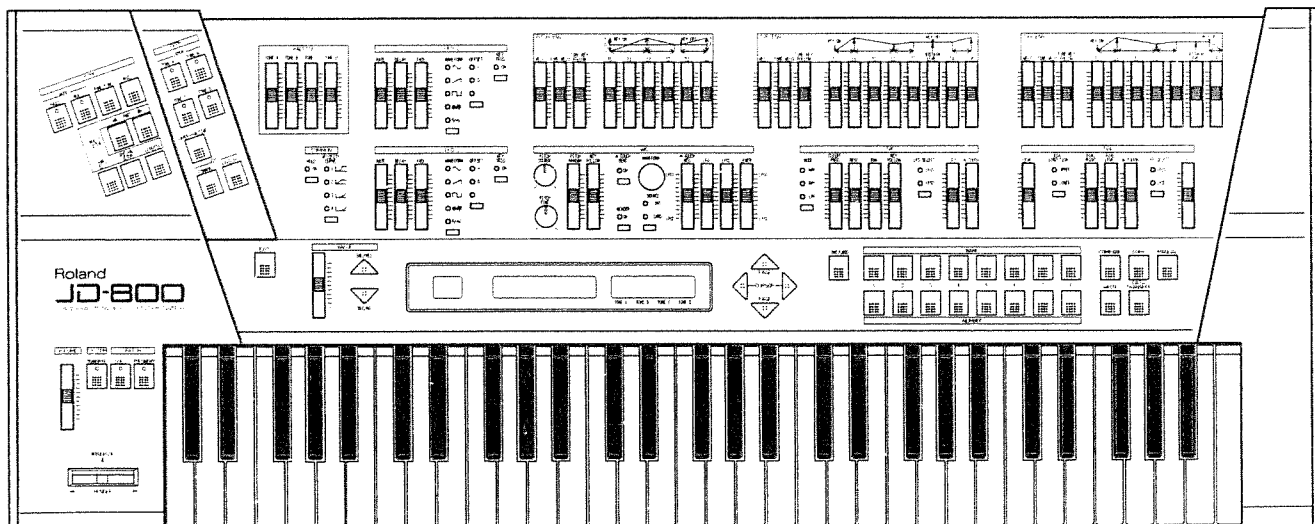

Roland JD - 800

Programmable Synthesizer

**Owner's Manual II
(Reference)**

Read this manual after you have read the Owner's Manual I (User's Guide) and have actually used the JD-800.

This manual is for your reference when you come across something you don't understand, or when you want to learn about the parameters in more detail.

©Copyright 1991 by ROLAND CORPORATION

All rights reserved. No part of this publication may be reproduced in any form without the permission of ROLAND CORPORATION.

TABLE OF CONTENTS

| | |
|-----------------------------------|----|
| OPERATION MAP | 6 |
| HOW THE JD-800 IS ORGANIZED | 9 |
| ● Tone | 9 |
| ● Patch | 9 |
| ● Special Setup | 10 |
| ● Memory | 11 |
| ● Single mode | 12 |
| ● Multi mode | 13 |
| ● Data transfer | 14 |

Section I Single mode operations

| | |
|--|--------|
| 1. SINGLE MODE | I - 2 |
| 1) Enter Single mode | I - 2 |
| 2) Select a Patch | I - 3 |
| 3) Before Tone editing | I - 4 |
| ● How a Tone is organized | I - 4 |
| ● Functions during Tone editing | I - 5 |
| ○ Select the Layer Tones | I - 5 |
| ○ Select the Active Tones | I - 6 |
| ○ Parameter view | I - 7 |
| ○ Original value | I - 8 |
| ○ Palette | I - 9 |
| ○ Tone Copy | I - 10 |
| ○ Manual | I - 12 |
| 2. TONE EDIT | I - 14 |
| ● Common | I - 15 |
| ● LFO 1/2 | I - 19 |
| ● WG | I - 27 |
| ● Pitch envelope | I - 44 |
| ● TVF | I - 50 |
| ● TVF envelope | I - 60 |
| ● TVA | I - 66 |
| ● TVA envelope | I - 75 |
| 3. PATCH EDIT | I - 81 |
| ● How a Patch is organized | I - 81 |
| ● Functions during Patch editing | I - 82 |
| ◇ Patch write | I - 83 |
| ◇ Patch compare | I - 84 |
| ○ Patch copy | I - 86 |

| | |
|---------------------------------|---------|
| 1) Patch Effects settings | I - 88 |
| ● Patch Effects | I - 88 |
| ○ Sequence A | I - 90 |
| ○ Switch A | I - 91 |
| ○ Sequence B | I - 92 |
| ○ Switch B | I - 93 |
| ○ Dry/Effects balance B | I - 94 |
| ○ Distortion setup | I - 95 |
| ○ Phaser setup | I - 97 |
| ○ Spectrum setup | I - 100 |
| ○ Enhancer setup | I - 102 |
| ○ Chorus setup | I - 104 |
| ○ Delay setup | I - 107 |
| ○ Reverb setup | I - 112 |
| 2) Patch Common settings | I - 117 |
| ● Patch Common | I - 117 |
| ● Patch Common / MIDI Tx | I - 131 |
| ● Patch Common / EQ setup | I - 138 |

Section II Multi mode operations

| | |
|--|---------|
| 1. MULTI MODE | II - 2 |
| 1) Enter Multi mode | II - 2 |
| 2) Select a Part | II - 3 |
| 3) Select a Patch | II - 4 |
| 2. EDITING IN MULTI MODE | II - 5 |
| 1) How Multi mode is organized | II - 5 |
| 2) Part edit | II - 6 |
| ● How a Part is organized | II - 6 |
| ○ MIDI receive channel | II - 8 |
| ○ Level | II - 9 |
| ○ Pan | II - 10 |
| ○ Output assign | II - 11 |
| ○ Effect mode | II - 12 |
| ○ Effect level | II - 13 |
| 3) Special Setup edit | II - 14 |
| ● How a Special Setup is organized | II - 14 |
| ○ Key setup | II - 15 |
| ○ Common setup | II - 24 |
| ○ EQ setup | II - 26 |

- Functions in Special Setup editing ··· II – 28
 - ◇ Special setup write ········· II – 28
 - ◇ Key setup copy ········· II – 30
- 4) Effects edit ········· II – 31
 - How the effects are organized ····· II – 31
 - Chorus setup ········· II – 32
 - Delay setup ········· II – 33
 - Reverb setup ········· II – 34

Section III System Settings

- 1. HOW THE SYSTEM PARAMETERS ARE ORGANIZED** ········· III – 2
- 2. TUNE / FUNCTION** ········· III – 3
 - Master tune ········· III – 4
 - Transpose switch ········· III – 5
 - Transpose value ········· III – 6
 - External control ········· III – 7
 - Bass control ········· III – 8
 - Mid control ········· III – 8
 - Treble control ········· III – 8
 - Chorus switch ········· III – 9
 - Delay switch ········· III – 9
 - Reverb switch ········· III – 9
- 3. MIDI** ········· III – 10
 - Local control ········· III – 11
 - Unit number ········· III – 12
 - Transmit channel ········· III – 13
 - Receive channel
(Single mode only) ········· III – 15
 - Program change transmission ····· III – 16
 - Program change reception ······· III – 18
 - Aftertouch transmission ········· III – 19
 - Aftertouch reception ········· III – 20
 - Volume reception ········· III – 21
 - Breath reception ········· III – 22
 - Exclusive reception ········· III – 23
 - Edit data transmission ········· III – 24

Section IV Data Transfer

- 1. Card initialize** ········· IV – 2
 - Card initialize ········· IV – 2
- 2. DATA TRANSFER WITH A CARD** ··· IV – 4
 - Card save ········· IV – 4
 - Card load ········· IV – 6
 - Exchange ········· IV – 8
- 3. DATA TRANSFER WITH AN EXTERNAL DEVICE** ········· IV – 10
 - Patch dump ········· IV – 10
 - Bulk dump ········· IV – 12
- 4. HOW TO RESTORE THE FACTORY SETTINGS** ········· IV – 14
 - Factory preset ········· IV – 14

Section V Appendix

- IDEAS FOR CREATING YOUR OWN SOUNDS ········· V – 2
- ROM PLAY ········· V – 28
- SUPPLEMENTARY MATERIAL ········· V – 29
- WAVEFORM LIST ········· V – 34
- PARAMETER LIST ········· V – 37
- BLANK CHARTS ········· V – 46
- Roland Exclusive Messages ········· V – 51
- MIDI Implementation ········· V – 53
- MIDI Implementation Chart ········· V – 65
- SPECIFICATIONS ········· V – 71
- TOPICAL INDEX ········· V – 72
- INDEX ········· V – 77



OPERATION MAP

This map shows all the functions of the JD-800, and tells you the page to refer to for details.

【Single mode】

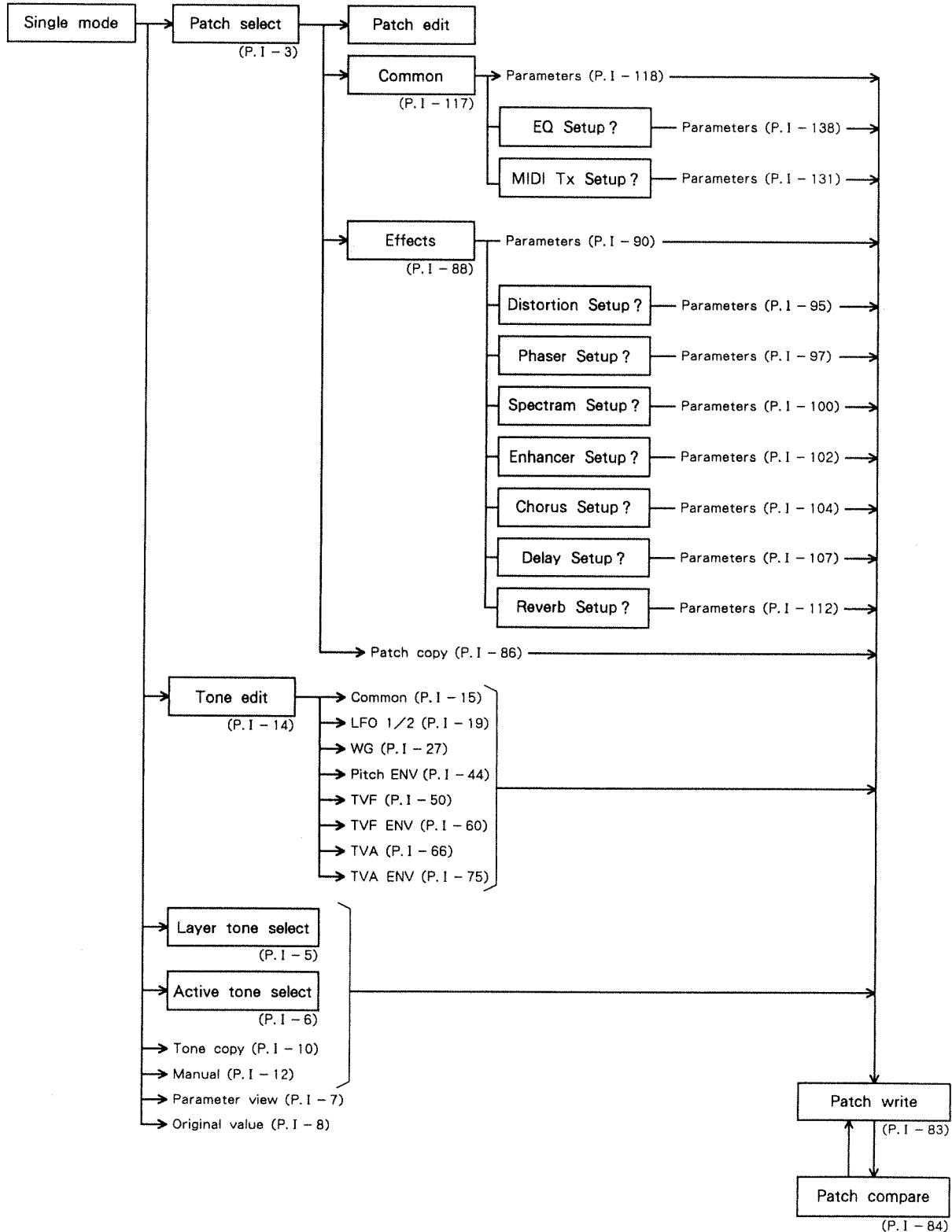

【Multi mode】

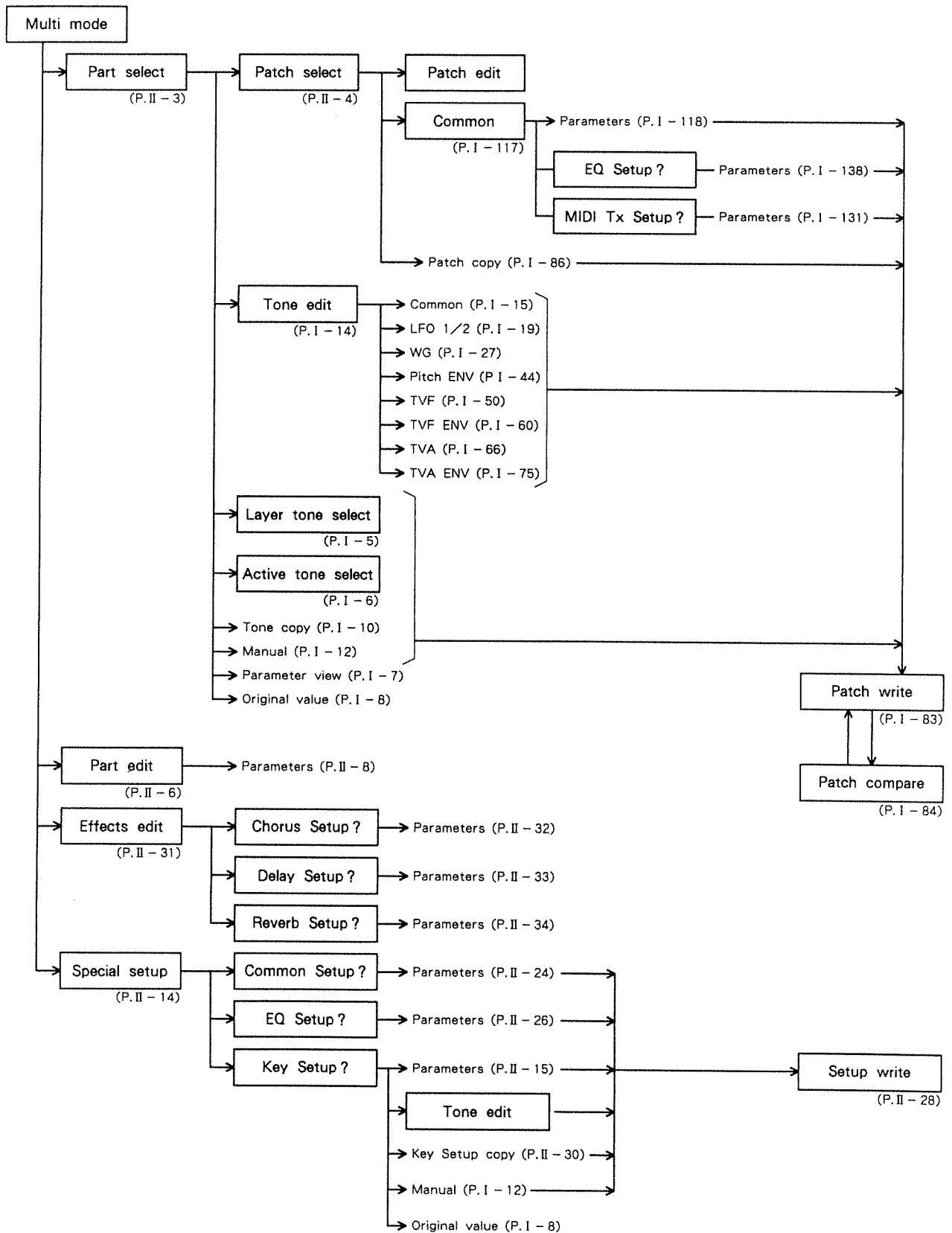

【Tune/Function】



【MIDI】



【Data Transfer】

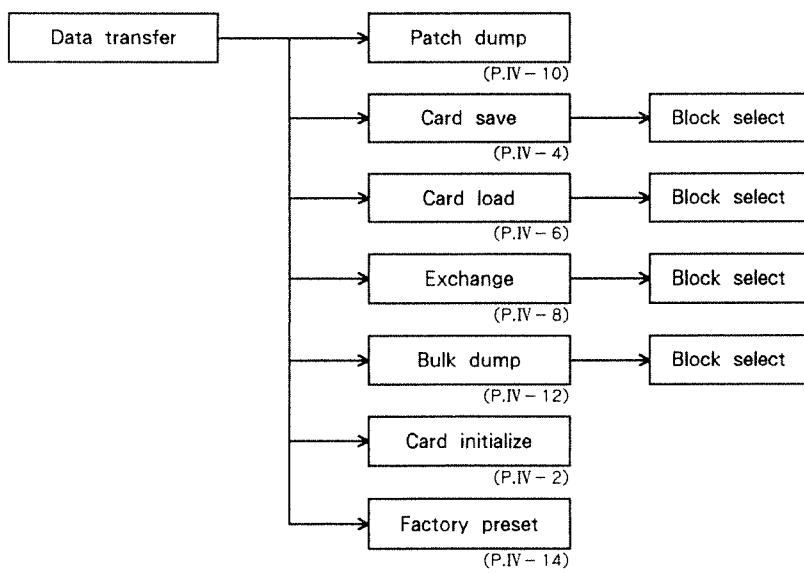

HOW THE JD-800 IS ORGANIZED

This section explains how the JD-800 is organized. It will explain how Tones and Patches are combined, and the signal flow in each mode.

● Tone

Tone is the minimum unit of sound that is created by the combination of parameters.

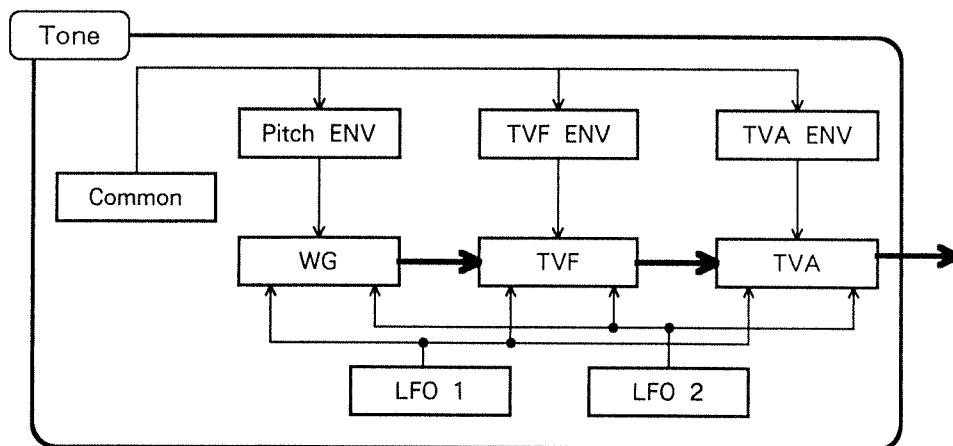

● Patch

A Patch is a sound that is created by combining Tones (1—4), effects settings, and the settings for controlling external devices. 64 patches can be stored internally and an additional 64 patches can be stored on a separately sold DATA card for a combined total of 128. Either Single or Multi mode can be selected but when in Multi mode, the patch effect settings are ignored.

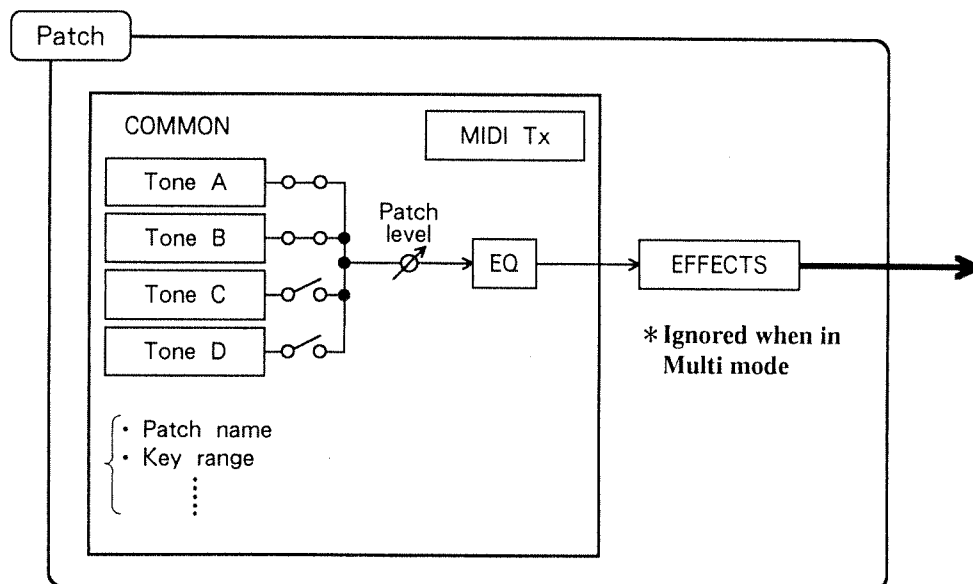

● Special Setup

A Special Setup is a function of multi mode, which a different tone can be assigned to each key of the keyboard (C2—C7). One Special Setup can be stored internally and one can be stored on a DATA card.

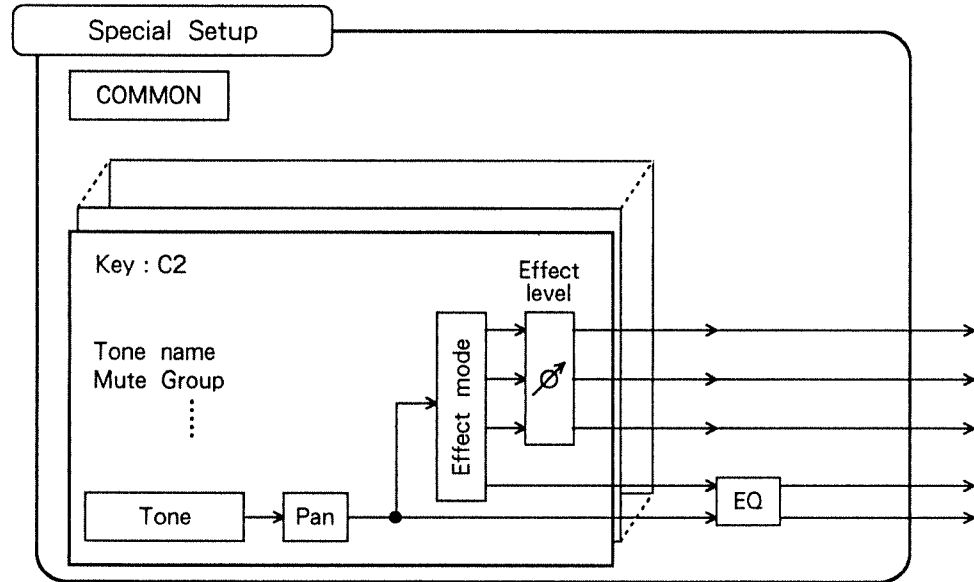

● Memory

Memory is the location where tone, patch, Special Setup data, etc., are stored. The JD-800 has two types of memory: Internal (INT) and DATA card (CARD). Data can be selected from either type of memory.

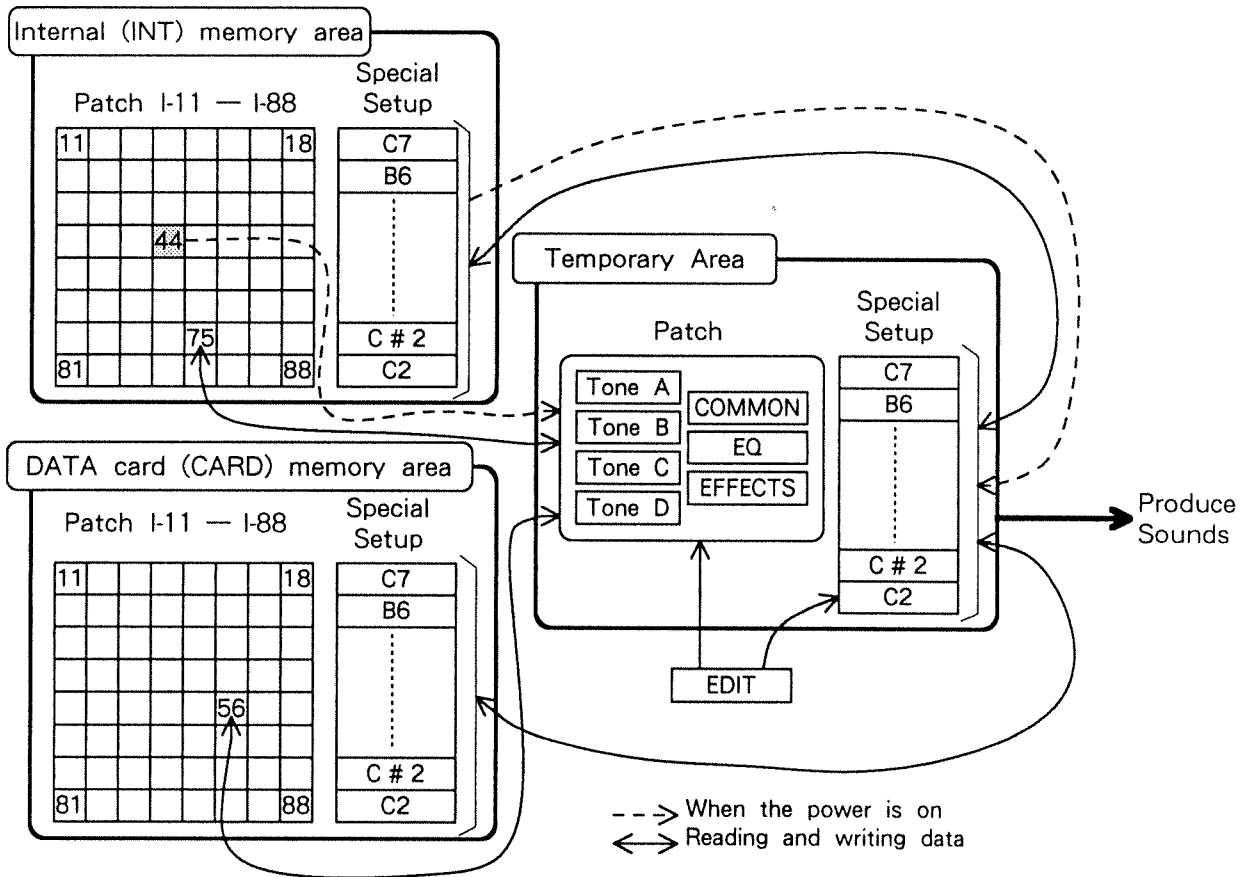

When you turn the power on, the previously selected patch and internal Special Setup data will be read into the temporary area and that data will determine the sound that will be heard when the keyboard is played. Then, if a different patch or DATA card setup is selected, the new data will be read into the temporary area.

Also, if a patch or Special Setup is edited, the edited values will be read into the temporary area.

Data in the temporary area is not permanent. If you change patches or setup data, the previous data in the temporary area will be lost. To avoid this, it is necessary to write the newly edited data to the memory area of the device, either internal (INT), or a DATA card (CARD).

● Single mode

“Single mode” is the play mode in which you can select and play individual Patches from internal memory or a DATA card. In other words in Single mode, the entire JD-800 will function as one instrument. In Single mode you can move the front panel sliders to edit Tones, and edit, copy, or write Patches.

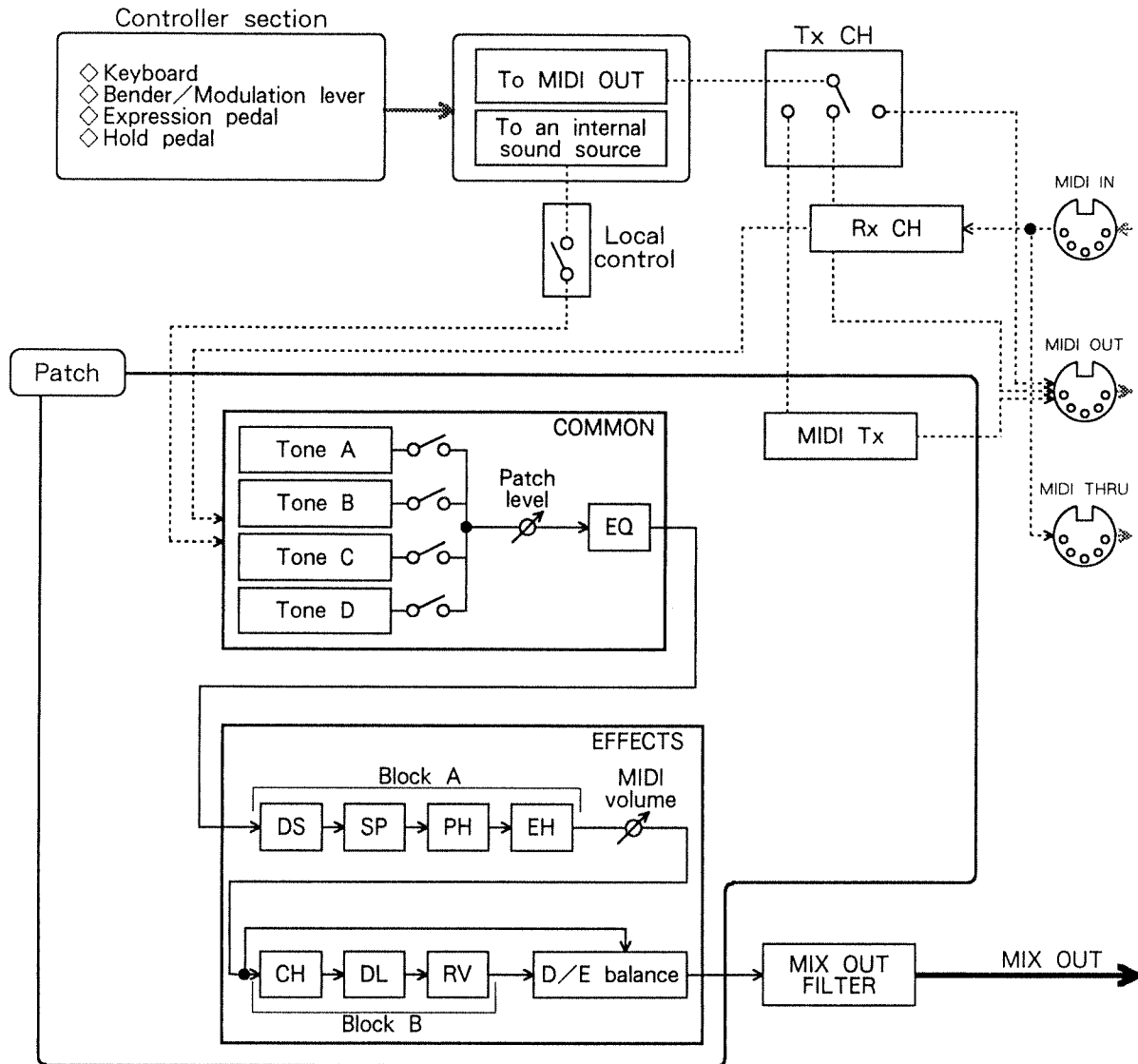

● Multi mode

“Multi mode” is the play mode in which you can play several Patches at once. You will usually use Multi mode when the JD-800 is connected to a sequencer.

In Multi mode, the JD-800 functions as 5 Synth Parts and a Special Part. You will assign a Patch to each of the five Synth Parts, and the Special Setup to the Special Part.

In Multi mode, you can edit the Patch you are currently playing, and also use functions such as Tone edit, Part edit, Effects edit, and Special Setup edit.

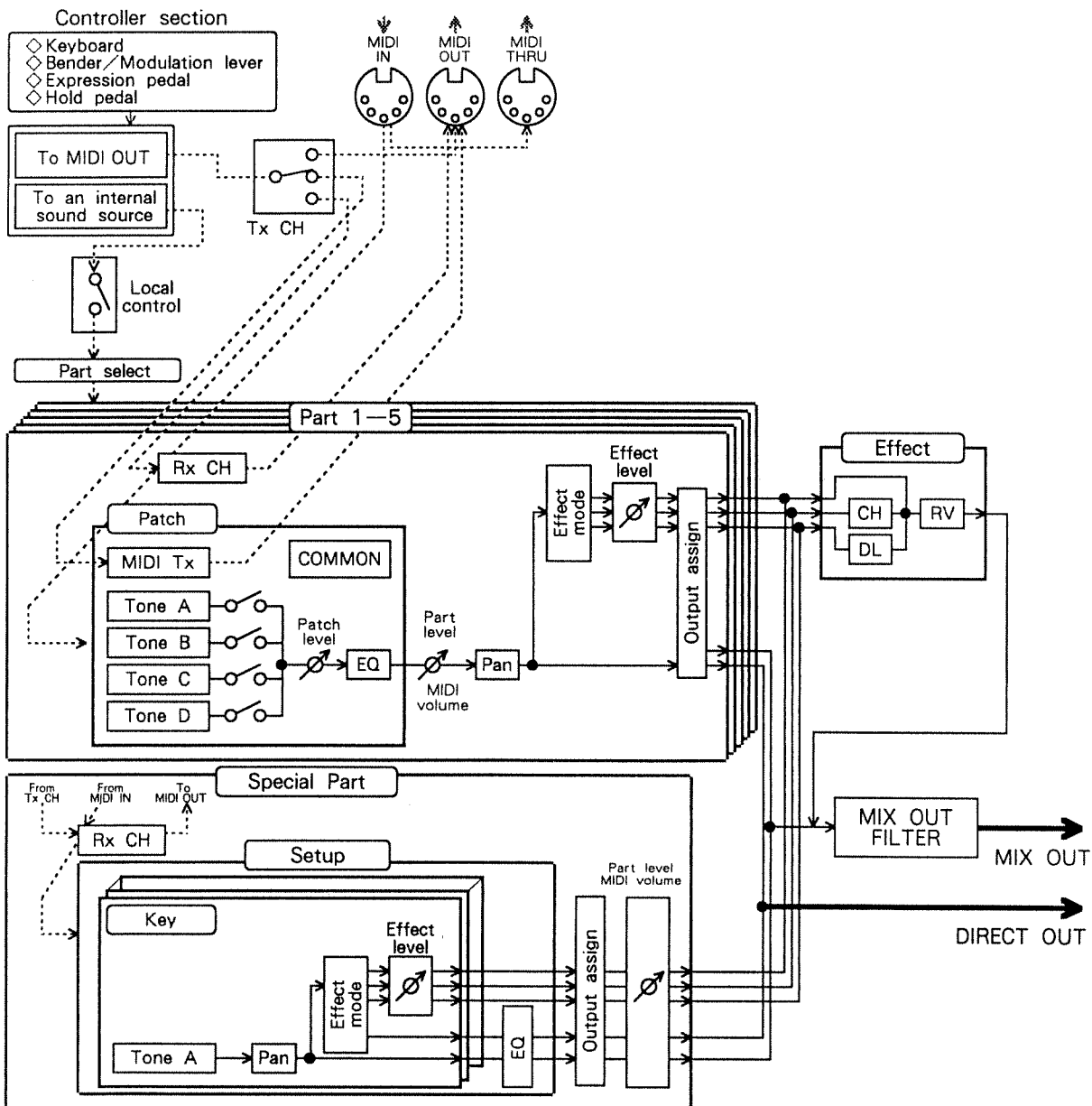

● Data transfer

This procedure is for exchanging data with external devices. You can read or write JD-800 data to a DATA card, transmit data to an external MIDI device, or restore all data to the factory settings.

◇ Patch dump (⇨ P.IV – 10)

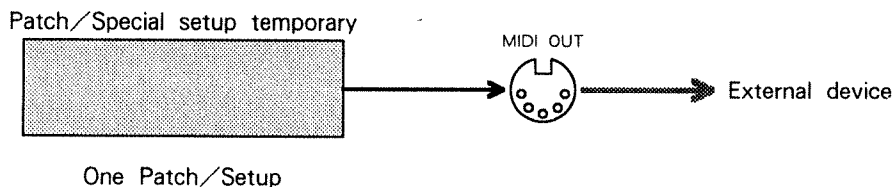

◇ Card save (INT → CARD) (⇨ P.IV – 4)

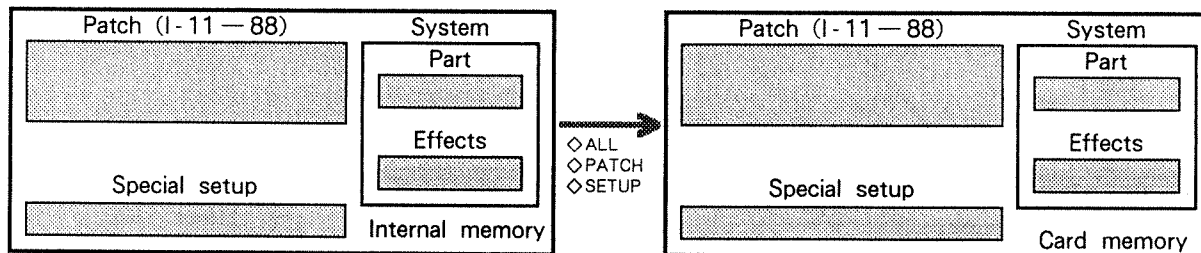

◇ Card load (INT ← CARD) (⇨ P.IV – 6)

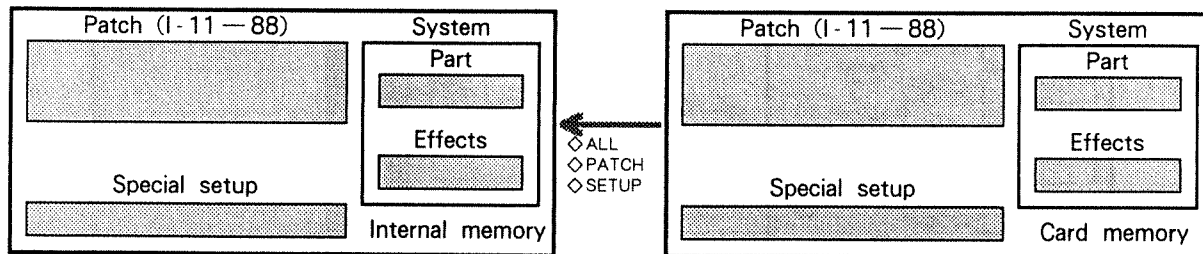

◇ Exchange (INT ↔ CARD) (⇨ P.IV – 8)

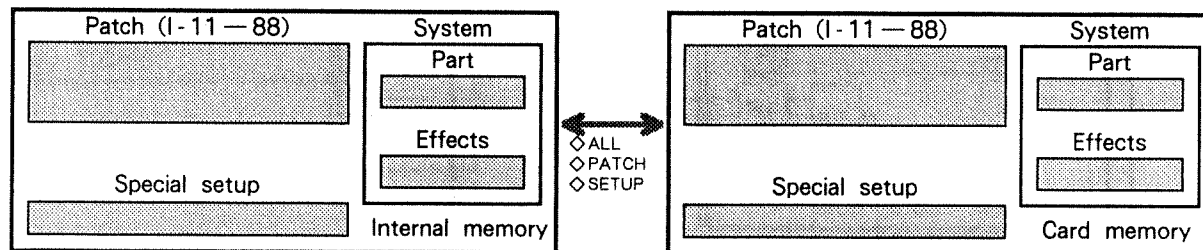

◇ Bulk dump (INT → MIDI) (☞ P.IV - 12)

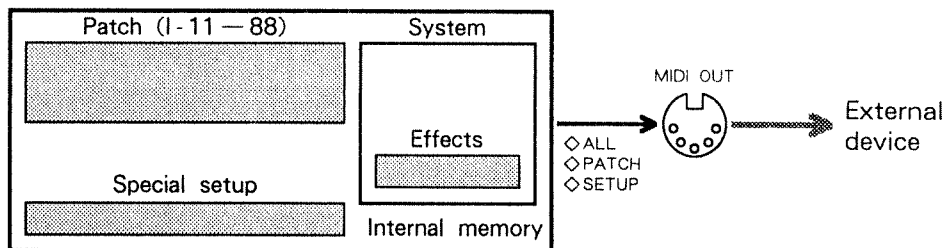

◇ Card Initialize (☞ P.IV - 2)

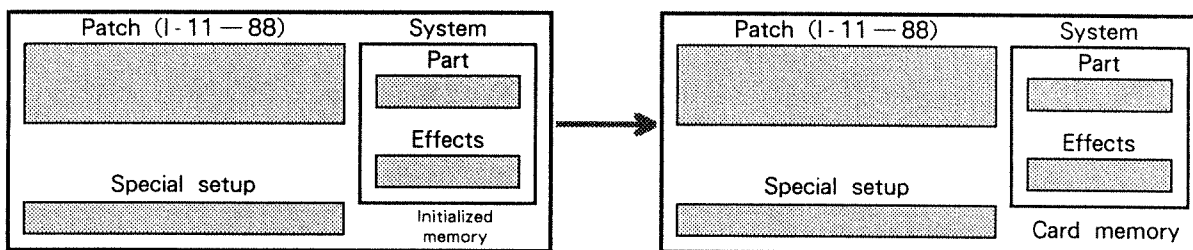

◇ Restore Factory Preset (☞ P.IV - 14)

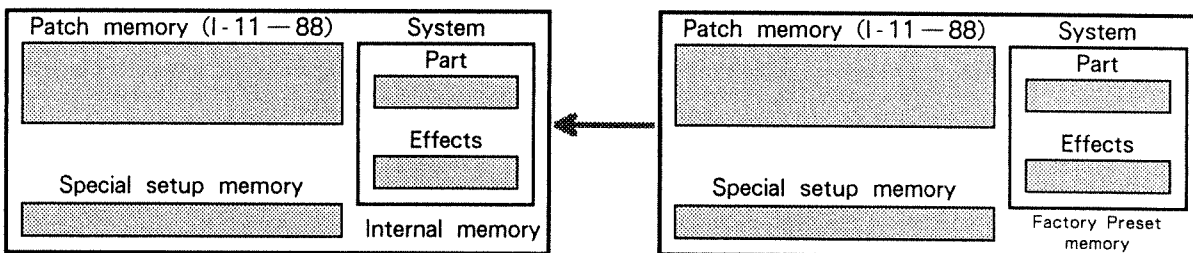

【MEMO】

Section I

***Single mode
operations***

1. SINGLE MODE

In Single mode, the JD-800 will function as a single instrument.

1) Enter Single mode

Here's how to enter Single mode.

- ① Press **SINGLE**. The indicator will light.

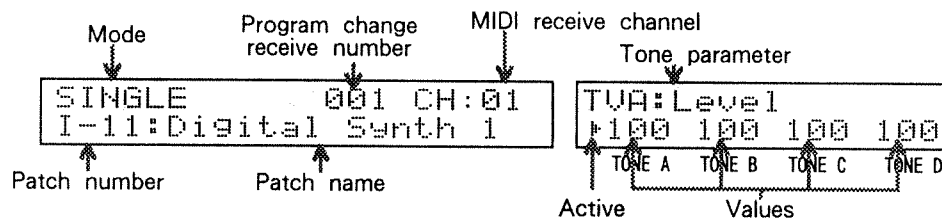

The left display will show Patch information, and the right display will show Tone information.

○ Mode

This indicates the current mode. In addition to Play mode, other modes indicated in this area include Edit, Write, Compare, and Copy.

○ Program change number

This indicates the Program Change number that will be received by the currently selected Patch. Internal memories I-11 — I-88 correspond to program change messages 1 — 64. If you are using an optional DATA card, C-11 — C-88 correspond to program change messages 65 — 128.

○ Patch number

This indicates the Patch number.

You can select from 64 internal Patches I-11 — I-88, and when using a DATA card, 64 additional Patches C-11 — C-88.

○ Patch name

This indicates the name of the selected Patch.

○ Active (**▶**)

This indicates the Tone that will be edited by the sliders and switches of the front panel.

○ Tone Parameter

This indicates the parameter (the element or aspect of the sound) of the Tone that you are currently editing.

When you select a patch, the TVA level will always be shown in the display.

○ Value

This indicates the value of the Tone parameter. The values for the four Tones are displayed simultaneously.

2) Select a Patch

Here's now to select a Patch to play.

- ① Press any button BANK 1—8.

The patch number will begin blinking.

- ② Press any button NUMBER 1—8, and the Patch will change.

If you are using a DATA card, you can press INT/CARD to select Patches from the DATA card. This allows you to select from a total of 128 Patches I-11 to C-88.

Patches can also be selected by MIDI Program Change messages received from an external device.

* While the Patch number is blinking, the Patch has not yet changed. Then press NUMBER 1—8 to select a patch.

* The current patch will remain in memory even if you turn the power off.

* If a DATA card has not been inserted into the JD-800's card slot, the following display will briefly appear when you press INT/CARD, and you will not be able to select DATA card Patches.

DATA card is not ready

* Before using a newly purchased DATA card, you must initialize it. (☞ P. IV - 2)

What does it mean to "select a Patch"?

When you "select a Patch", the Patch data stored in the Memory area is actually copied into the Temporary area. The data in the Temporary area will determine how sound is produced. When you edit a Patch, your edits affect only the data in the Temporary area.

How a tone is organized

3) Before Tone editing

“Tone editing” refers to the process of modifying the parameters of a “Tone”; the smallest subdivision of a JD-800 sound. Modifications you make affect only the temporary area, and will be lost if you select another Patch or turn the power off.

● How a Tone is organized

A Tone consists of many parameters.

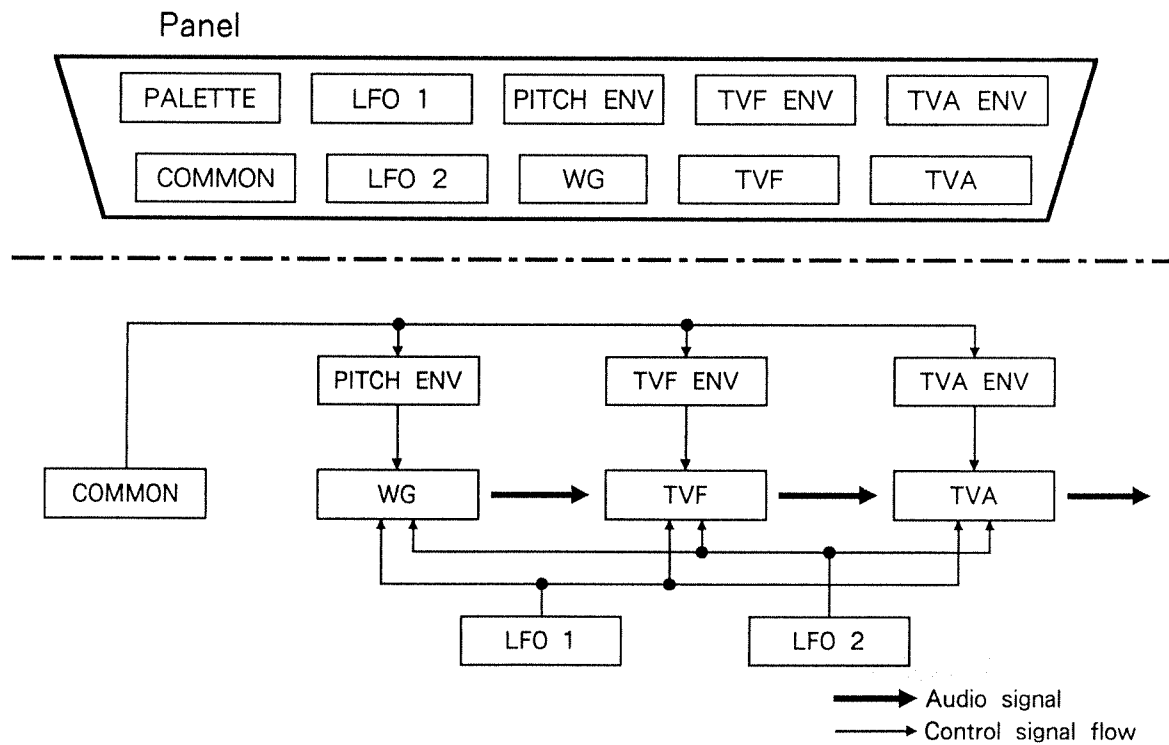

In order to make it easy to edit Tones, the parameters on the front panel are divided into several blocks.

● Functions during Tone editing

The JD-800 has several functions that help you edit Tones.

*If you wish to save a Tone you have edited, you must use the Patch Write ( P. I – 83) operation.

○ Select the Layer Tones



These buttons turn on/off (sound/mute) each of the four Tones (A — D).

This will determine the number of Tones used by the Patch. These buttons also allow you to check the sound of each individual Tone as you edit.

① Press a Layer block button  — .

When the indicator is lit, the corresponding Layer is On, and will be sounded by the Patch.
When the indicator is unlit, the corresponding Layer is Off, and will not be sounded by the Patch.

*The Layer on/off status of each Tone is remembered as part of the Patch data ( P. I – 129).

*When you select a Patch, the  —  indicators will light to show the layers used by that Patch.

Sound idea

- ◇By layering many Tones, you can create rich sounds.
- ◇If you will be playing many notes simultaneously, create Patches that use fewer Tones.
- ◇It is possible to create a Patch that uses no Tones (all Tones turned off, so there will be no sound), for cases in which you want to play only an external sound source.

*The JD-800 can produce up to 24 notes simultaneously. This means that up to 24 Tones can sound at once.

Thus, if a single Patch uses two or more Tones, the JD-800 will be able to produce fewer notes simultaneously.

| Number of Tones used | Maximum number of notes playable by the Patch |
|----------------------|---|
| 4 | 6 |
| 3 | 8 |
| 2 | 12 |
| 1 | 24 |

If all four Tones are turned on in the Layer block, not all the notes will sound when you play a chord of more than seven notes. If you need to play many notes simultaneously, create Patches with as few Tones as possible.

1. SINGLE MODE

Select the Active Tones

○ Select the Active Tones

Here's how to select the Tones that will be edited by the front panel sliders and switches.

- ① Press **LAYER** ↔ **ACTIVE**.

The indicator will change from lit to blinking.

- ② Press a button **TONE A** — **TONE D** to select the Tone you wish to edit.

A Tone whose indicator is blinking is active, and can be edited. A Tones whose indicator is unlit is inactive, and cannot be edited. If there are two or more active Tones, modifications you make in parameter values will apply to each active Tone. The panel indicators (LFO 1/2 waveform, etc.) will indicate the value of the lowest Tone (in A—D order) that is set to Active On.

* **The active/inactive status of each tone is remembered as part of the Patch data** (☞ P. I - 130).

* **It is also possible to edit a Tone which is set to Layer Off (not sounding).**

* **If you wish to independently edit the same parameter of two or more Tones, use** **PALETTE** (☞ P. I - 9). The four Palette sliders will edit the currently selected parameter for each of the four Tones.

Note 1

The right display also shows a **⌘** mark to indicate the Active on/off status of each Tone. For example, in the situation shown in the following display, moving the **CUTOFF FREQ** slider will simultaneously set the same Cutoff Frequency value for all Tones A/B/C.



Note 2



With the four Tones set to Active Off, you can move any slider or switch to check the values in the temporary area. For example if you move the **PITCH COARSE** slider, the display will change as follows.



This has the same result as the Parameter View function (next page).

○ Parameter view

This function allows you to check the values of parameters in the temporary area. You can display the values of the temporary area without having to move a panel slider.

- ① Each time you press PAGE  , the parameter displayed in the right display will change.

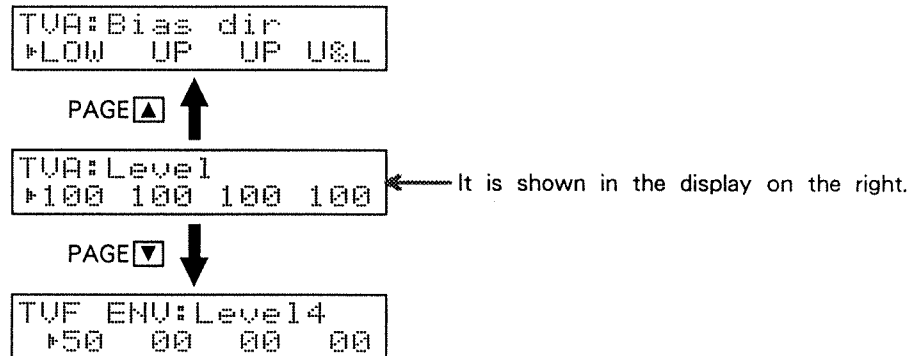

* By holding  () while pressing  () , you can scroll quickly through the displayed parameters.

The displayed parameter will move through the parameter blocks in the following order.

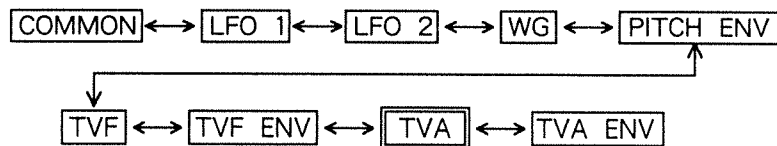

* When you select a Patch, this display will indicate the TVA Level.

* During Patch edit or Multi mode Special Setup edit, this “parameter view” function is not available.

When you need to check parameter values

As you edit a Tone, moving a slider/switch will cause the name and value of that parameter to appear in the display. This means that the displayed value will be the newly modified value. However, the “parameter view” function allows you to simply check the values without modifying them. After you have checked the value, you can modify it if necessary. You can also check parameter values by setting all Tones to Active Off, and moving a slider or switch (see the previous page).

1. SINGLE MODE

Original value

○ Original value

This function will display the Memory (internal or card) values of the currently selected parameter for each of the four Tones. This lets you compare the modified values (the data in the Temporary area) with the original values (the data in the Memory area).

① Press **COMPARE**.

While you are holding this button, the display will show the values stored in memory for the currently selected parameter.

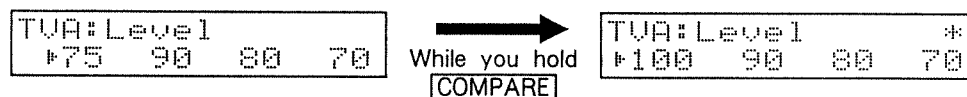

The “” indicates that the parameter being edited is at its original value.

If you wish to hear the original sound of the Tone, set the edited parameter values to match the original values.

***The sound that you hear at this time will be different than the displayed parameter values. The edited parameter values (in the Temporary area) will determine the sound you hear.**



In addition to this “original value” function, the **COMPARE** button also provides the “Patch compare” function (☞ P. I – 84).

○ Palette

The Palette allows you to independently edit the displayed parameter for each of the four Tones.

- ① Move a slider or switch.

or

Press PAGE   to select the parameter you wish to edit.

This will assign the parameter to the Palette.

- ② Move a PALETTE slider, and the parameter value of the corresponding Tone will change.

Immediately after you have selected a Patch, the display will show the TVA Level parameters, so the four sliders can be used to adjust the volumes of the four Tones just as if you were using a mixer. The four sliders will edit the values of each Tone for whatever parameter is displayed.

*** Only Tone parameters can be adjusted using the Palette sliders.**

*** It is possible to edit a Tone even if it is set to Active Off.**

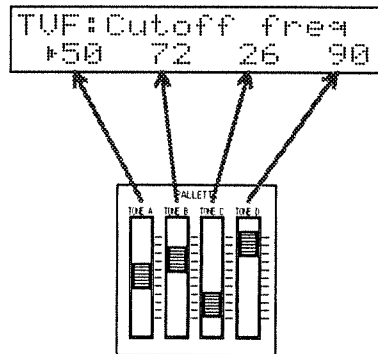

The parameter indicated in the display ...

can be edited independently for each Tone.

1. SINGLE MODE

Tone Copy

○ Tone Copy The “Copy” function is provided as a convenience when editing. This function copies data from a selected Patch into the Temporary area. In this example, we will show how to copy Tone parameters.

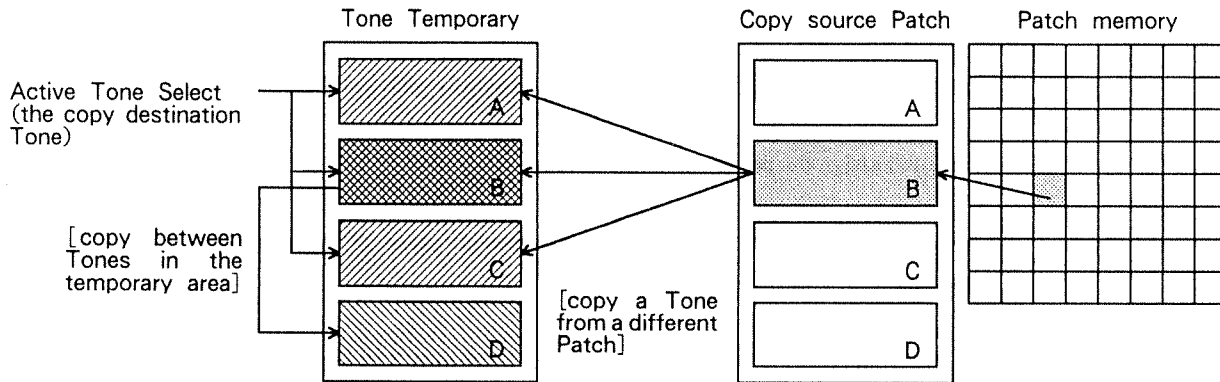

① While editing a Tone, press **COPY**.

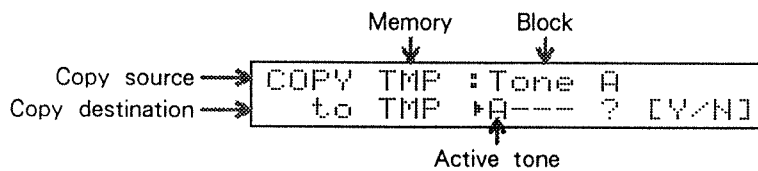

The upper line indicates the copy source memory and block. The lower line indicates the copy destination Active tone.

② Select the copy source Patch using **INT/CARD**, **BANK** **1**—**8**, and **NUMBER** **1**—**8**.

If you wish to copy tone data within the temporary area, select TMP as the memory.

③ Select the copy source block using **PAGE** **▲**/**▼**.

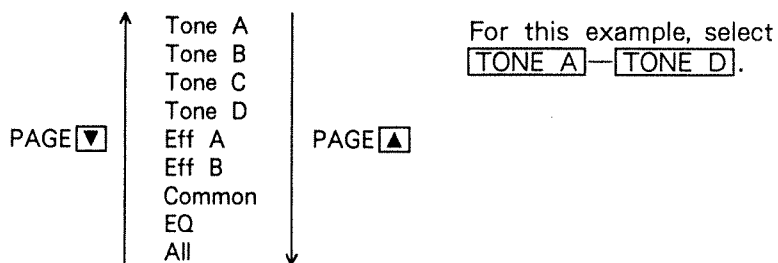

- ④ Select the copy destination Tone (the active Tone) using **TONE A**—**TONE D**.

```
COPY I-11:Tone B
to TMP *ABC- ? [Y/N]
```

You can select one or more Tones. The selected Tones will be indicated by a blinking indicator, and also in the display.

- ⑤ After you have specified the copy source and copy destination, press **INC/YES**.

The following display will appear.

```
COPY I-11:Tone B
Completed
```

To cancel without executing, press **EXIT** or **DEC/NO**.

```
COPY I-11:Tone B
Canceled
```

- ⑥ You will return to the previous display.

*** In steps ② and ③, you can play the keyboard to hear the selected copy source Tone.**

This lets you confirm the selected copy source by ear.

*** You cannot copy the Special Setup's tone.**

*** If you wish to store the copied Tone, you must use the Patch Write operation (P. I - 83).**

Sound idea

One way to create rich sounds (eg., for strings or brass) is to layer two or three similar Tones, slightly detuned. In such cases, you can use the copy function to copy a Tone to one or more other Tones, and adjust the Pitch Fine parameter of each Tone to a slightly different value.

○ Manual

This function writes the current status (position/value) of the front panel sliders and switches into the temporary area for one or more Tones.

When you select a Patch and begin Tone editing, the position of the sliders will not necessarily be the same as the values of the corresponding parameter. Especially when you wish to create a sound from scratch, it is important to hear the sound that results from the current slider settings. In such cases, you can use the Manual function to match all parameter values to the current slider positions before you begin editing.

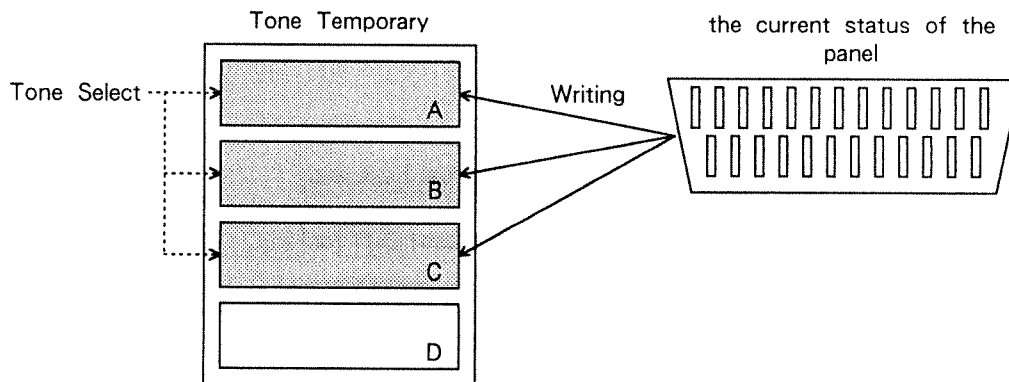

① Press **MANUAL**.

writing destination → `MANUAL
TMP:A--- ? [Y/N]`

② Specify the writing destination in the temporary area by pressing **TONE A** — **TONE D**.

`MANUAL
TMP:ABC- ? [Y/N]`

The lit indicators and the display will indicate the selected Tones.

③ Press **INC/YES**.

The following display will appear, and all parameter values will be set to the current values of the front panel sliders and switches.

`MANUAL
Completed`

To cancel the operation, press **EXIT** or **DEC/NO**.

`MANUAL
Canceled`

④ You will return to the previous display.

- * If you wish to save the Tone you create by this Manual function, you must use the Patch Write operation (⇨ P. I – 83).
- * If the tone write destination has not been selected in step ②, pressing **INC/YES** will cancel the function and “Canceled” will be shown in the display.
- * The previously selected waveform will not change.

Application ideas Once you become familiar with the editing process, you will be able to predict the approximate sound that will result from the slider positions. In this case, you could move the sliders and switches in anticipation of the Tone you want to create, and then execute the Manual operation.

2. TONE EDIT

Now that you have selected a Tone, let's edit it. You can edit a Tone by moving the front panel sliders and switches. Editing a Tone is how you create your own sound. The Tone you create can then be used in a Layer (☞ P. I - 5) to create a Patch.

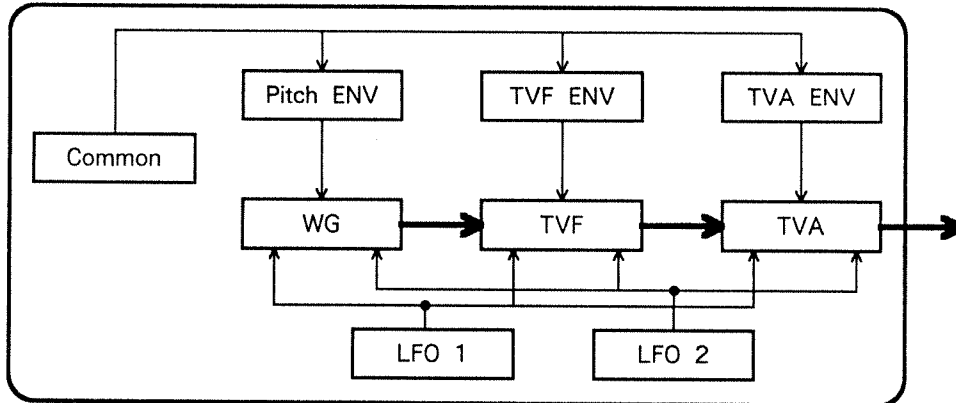

- * Pressing **YES/INC** / **NO/DEC** or moving **VALUE** will not affect Tone parameter values. Only the panel sliders and switches can be used for Tone editing.
- * The Tone parameter sliders must be moved a certain amount before the value will change. If a parameter value does not change when you make a slight change in slider position, move the slider up or down more greatly.

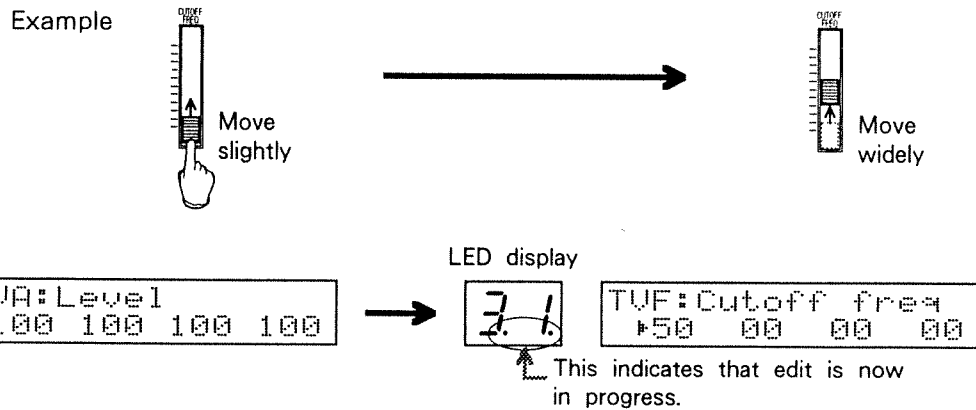

When a parameter value is modified, a dot "." will appear in the LED display, indicating that the value of the original Patch has been modified.

● Common

These parameters can be set independently for each Tone.

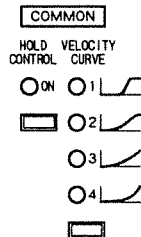

- **Hold control** This parameter determines whether or not the Tone will be sustained by a pedal switch (DP-2 etc., sold separately) connected to the Hold Pedal jack.

① Press **HOLD CONTROL**.

When this function is on, the indicator will light. When off, the indicator will be dark.

```
COM: Hold ctrl
ON ON OFF OFF
```

[Values] [ON, OFF]

ON : The Hold effect will apply.

OFF : The Hold effect will not apply.

* This setting also determines the effect of Hold messages from MIDI IN.

* Hold messages will be transmitted from MIDI OUT.

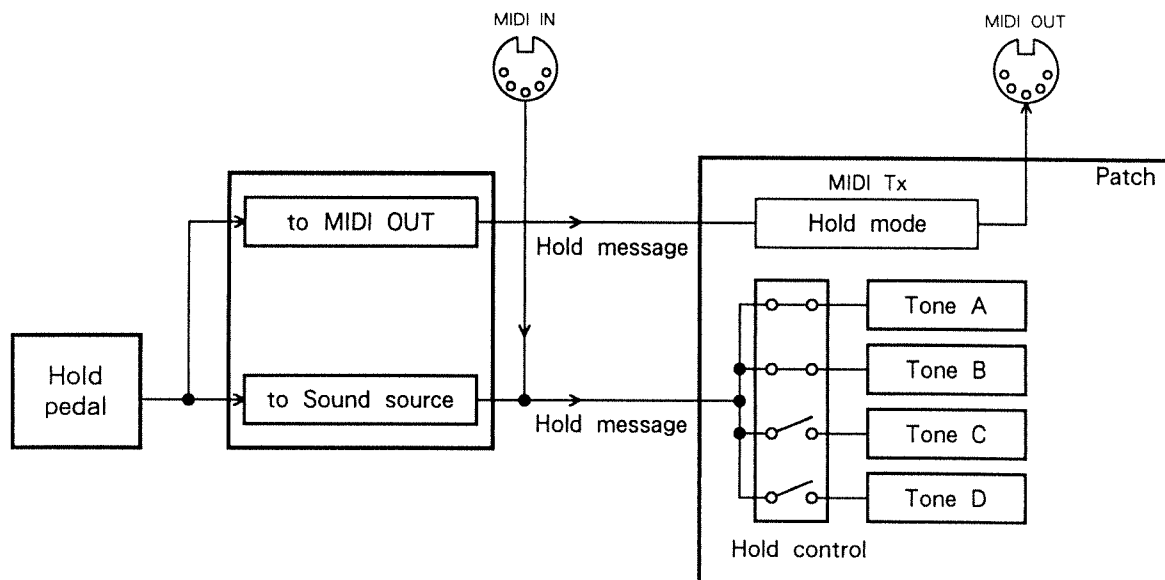

2. TONE EDIT

Tone edit/Common/Hold control

Sound idea

For example if you are layering strings and piano, you might set the strings to be held, and the piano to not be held.

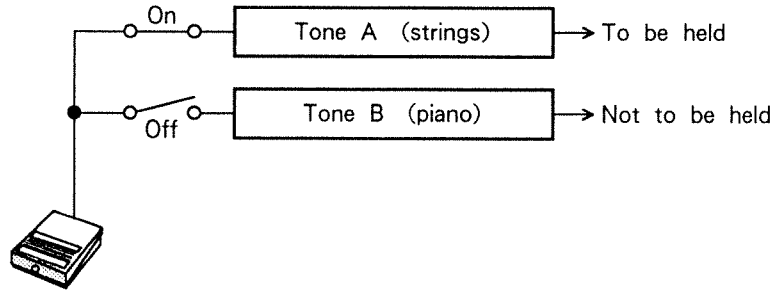

The Hold parameter is also useful when you assign a different Key Range setting to each Tone to create keyboard splits (☐ P. I - 120); for example, you might enable Hold only for the lower (or upper) Tone.

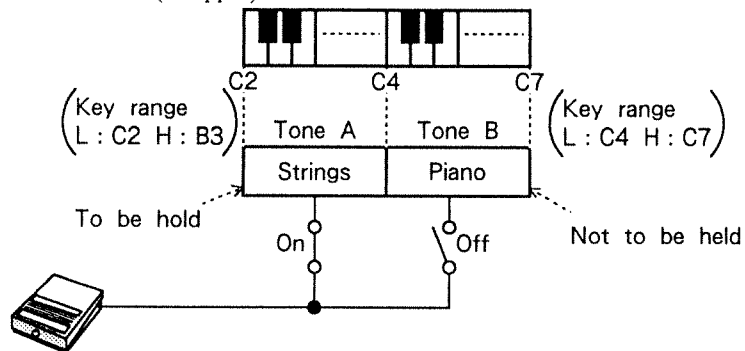

○ Velocity curve

Velocity (keyboard playing strength) can be used to control volume or other parameters. If you select a different curve for each Tone, your keyboard dynamics can switch between Tones (velocity switch) or determine how Tones are mixed (velocity crossfade). You can select a velocity curve that is appropriate for your own style of playing.

- ① Press **VELOCITY CURVE** to select one of the four curves.

The indicator for the selected curve will light.

```
COM:Velo curve
▶01 02 03 04
```

【Values】 [1—4]

In the following diagrams, the horizontal axis indicates the velocity you play on the keyboard, and the vertical axis indicates the velocity value that it will be converted into.

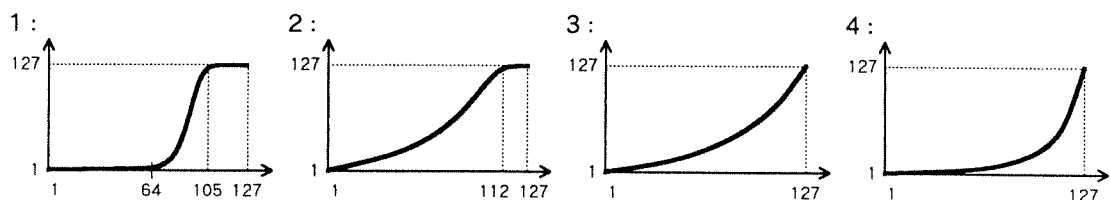

*This velocity curve also determines the result of the velocity value of Note messages received from MIDI IN.

*The actual keyboard velocity will be used for the Note messages transmitted from MIDI OUT.

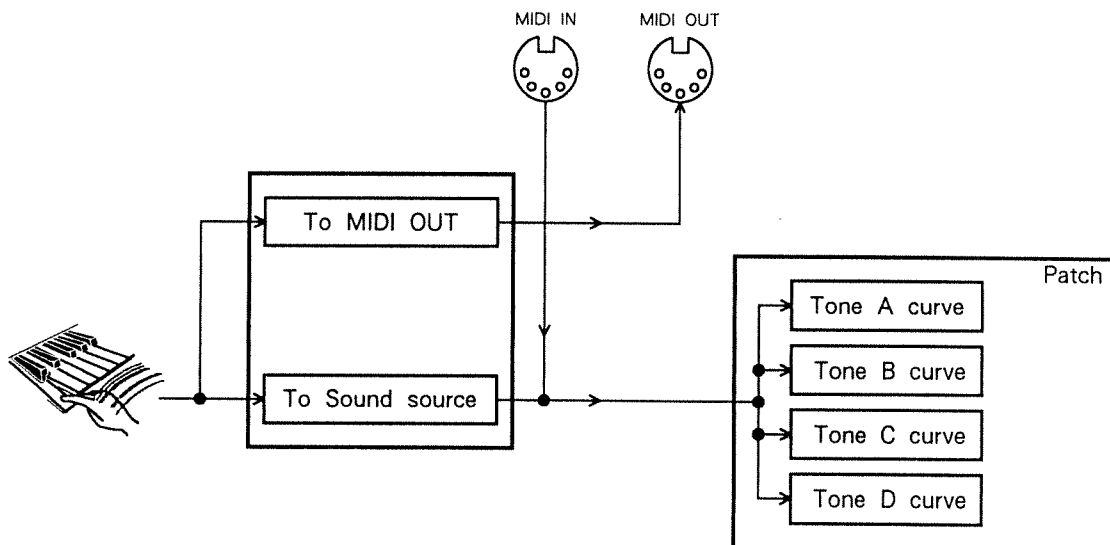

2. TONE EDIT

Tone edit/Common/Velocity curve

Note This setting applies to the following parameters.

- Pitch Envelope Velocity (☞ P. I - 45)
- Pitch Envelope Time Velocity (☞ P. I - 46)
- TVF Envelope Velocity (☞ P. I - 61)
- TVF Envelope Time Velocity (☞ P. I - 62)
- TVA Envelope Velocity (☞ P. I - 76)
- TVA Envelope Time Velocity (☞ P. I - 77)

Sound idea For example if you set each of two Tones to a curve of 2, and set their TVA ENV Velocity Sens respectively to +50 and -50, changes in velocity will adjust the mixture of the two Tones (velocity crossfade).

Tone A will sound for strongly played notes.
Tone B will sound for softly played notes.

● LFO 1/2

This block determines the shape of the LFO that can be used to cyclically modify the pitch, cutoff frequency, or level.

LFO stands for Low Frequency Oscillator, and can be used to create modulation effects such as vibrato, wah-wah, and tremolo. Two independent LFOs (1 and 2) are provided, allowing greater possibilities and more detailed settings.

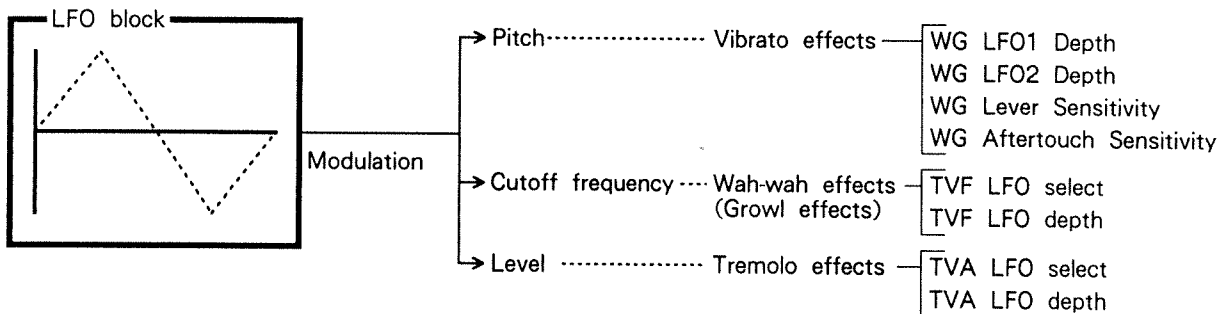
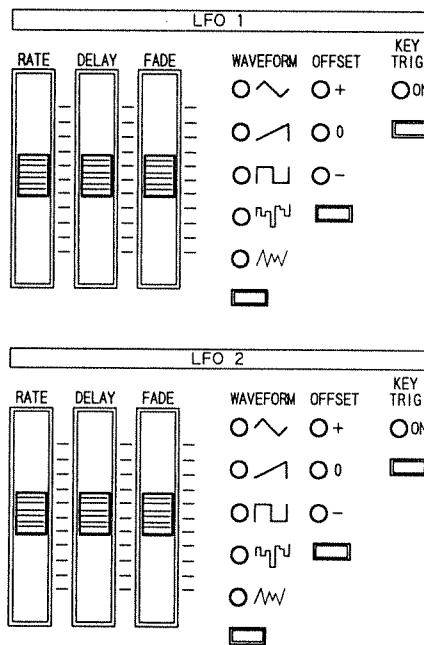

2. TONE EDIT

Tone edit/LFO 1/2/Rate

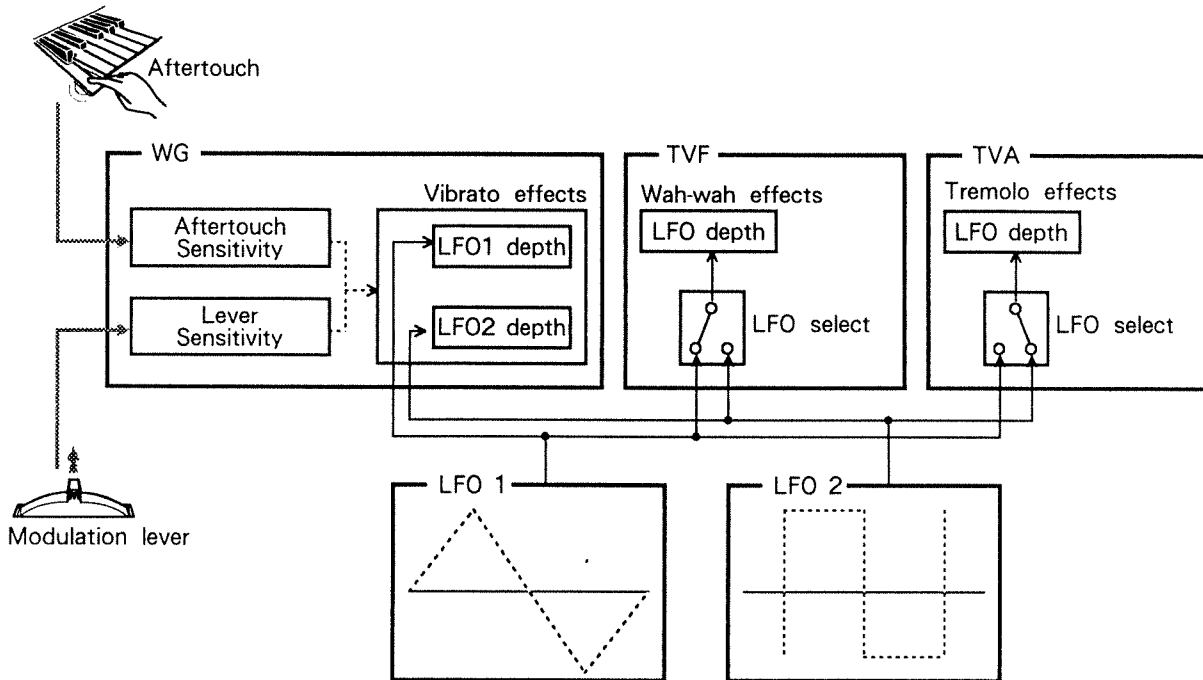

The following parameters determine the depth of the effect produced by the LFO waveform you specify here.

- ◇WG LFO1 Depth (P. I - 41)
- ◇WG LFO2 Depth (P. I - 42)
- ◇WG Lever Modulation Sensitivity (P. I - 43)
- ◇WG Aftertouch Modulation Sensitivity (P. I - 39)
- ◇TVF LFO Depth (P. I - 58)
- ◇TVA LFO Depth (P. I - 74)

○ Rate

This parameter determines the frequency of the LFO.

- ① Move **RATE**.

```
LFO1:Rate
 75  70  65  90
```

[Values] [0—100]

Higher values will result in faster modulation.

○ Delay

This parameter determines the time delay from when you press a key to when the LFO begins to be applied. On acoustic instruments, vibrato is usually applied shortly after a note begins. This “Delay” parameter allows you to simulate this effect.

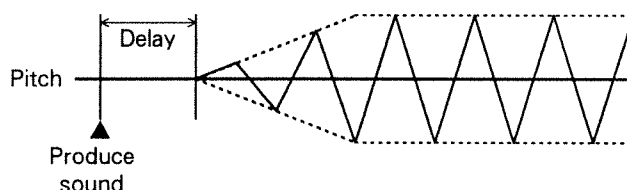

① Move **DELAY**.

The lowest position will result in a value of 0, and the highest position will result in a value of REL.

```
LFO1: Delay
▶20 30 20 REL
```

【Values】 [0—100, REL]

0—100 : Higher values will result in a longer delay from when the key is pressed to when the LFO is applied.

REL : The LFO will be applied immediately after the key is released.

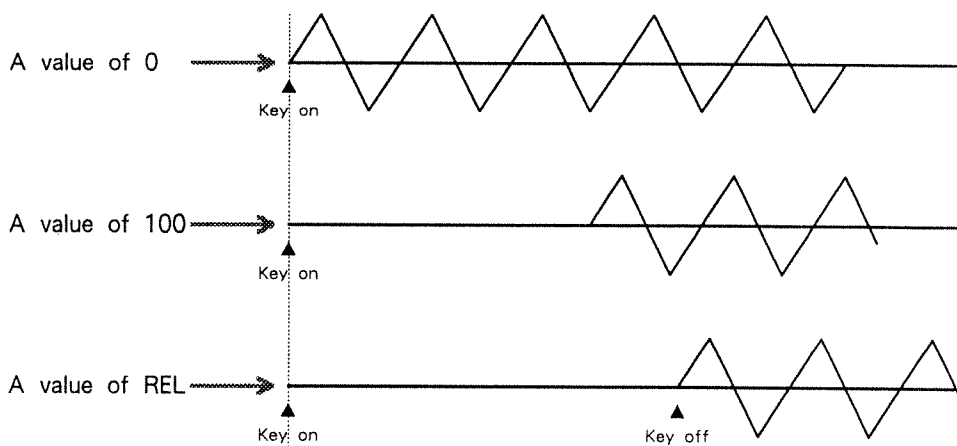

If you set this to REL, the LFO effect will be applied immediately after the key is released, which can be interesting when used in sound effects. By using this parameter in conjunction with appropriate settings of the Fade parameter (next page), a variety of effects can be obtained.

* In the following cases, the REL setting may have no effect.

- ◇ When the TVA envelope T4 parameter is 0, or close to 0 (☞ P. I - 80)
- ◇ When in a Special Tone, the Envelope Mode is “No Sustain” (☞ P. II - 19)

○ **Fade**

This parameter determines the time over which the LFO will change in amplitude. The vibrato applied to acoustic instruments appears most natural when it is increased gradually. This parameter allows you to simulate such effects.

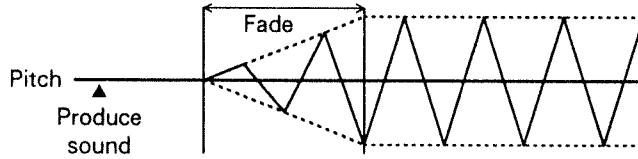

① Move **FADE**.

```
LFO1:Fade
+20 +20 -20 -50
```

[Values] [- 50— + 50]

For positive (+) settings, the LFO effect will gradually increase, and finally reach the specified LFO depth. For negative (-) settings, the LFO effect will begin at the specified LFO depth, and gradually decrease to zero. If this "Fade" parameter is set to 0, the specified LFO depth will be maintained continuously.

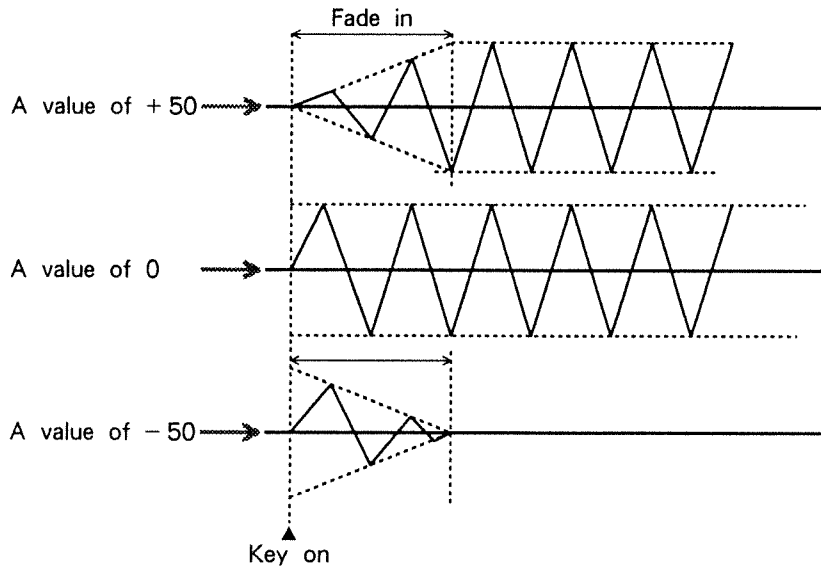

Sound idea

If you wish to add the LFO effect only to the beginning of the sound, set this parameter to a negative (-) value.

This can be used to simulate the unsteadiness in pitch that naturally occurs in the attack of brass sounds (such as trumpets). Make settings as follows.

RATE = 90, Delay = 00, Fade = - 20, Waveform = RND,
WG LFO1 (✓2) Depth = + 50

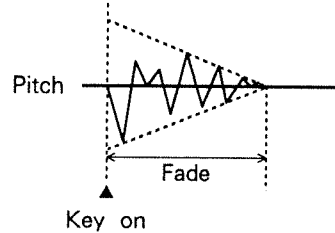

You can create a wide variety of sounds by combining with Delay on the previous page.

◇ Delay = 40, Fade = 30

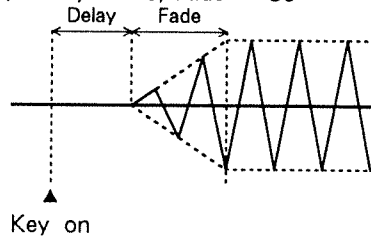

◇ Delay = REL, Fade = 0

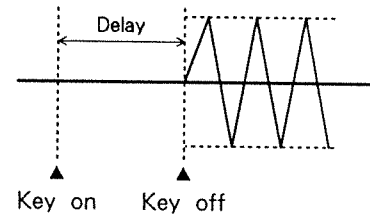

◇ Delay = 50, Fade = - 30

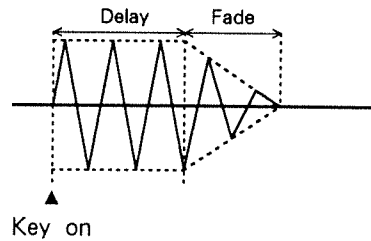

◇ Delay = REL, Fade = - 10

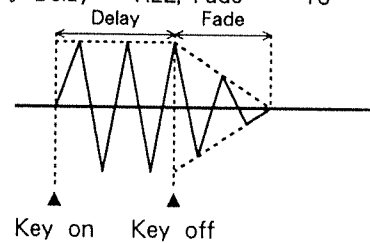

2. TONE EDIT

Tone edit / LFO 1 / 2 / Waveform

○ Waveform This parameter selects the LFO waveform (the shape of the change over time).

① Press **WAVEFORM** to select one of the five waveforms.

The indicator of the selected waveform will light.

```
LFO1:Waveform
*TRI SAW S/H RND
```

【Values】 [TRI, SAW, SQU, S/H, RND]

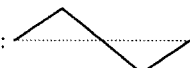
TRI:  Triangle wave is the most frequently used waveform, and is best for vibrato.

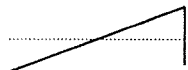
SAW:  Sawtooth wave is often useful for sound effects.

SQR:  Square wave is often useful for sound effects.

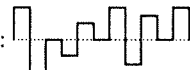
S/H:  Sample and Hold creates random "stepped" change (random level).

RND:  Random creates random "continuous" change (random level and slope).

Sound idea

For example, you can create a siren by selecting SQU and applying the LFO to modulate pitch.

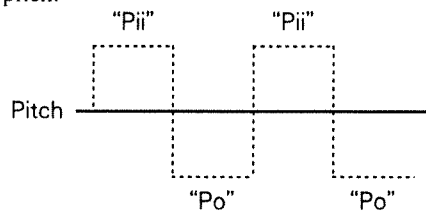

By setting the depth of the following parameters to negative (-) values, you can invert the waveform.

WG LFO1 Depth (☞ P. I - 41)

WG LFO2 Depth (☞ P. I - 42)

TVF LFO Depth (☞ P. I - 58)

TVA LFO Depth (☞ P. I - 74)

○ Offset

This parameter adjusts the LFO waveform up or down.

By setting the Offset parameter, you can raise or lower the center value of the parameter (pitch, cutoff frequency) which the LFO is affecting.

- ① Press **OFFSET**, and select one of the three values; "+", "0", or "-".

The indicator of the selected value will light.

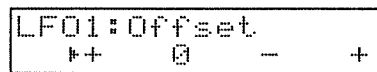

【Values】 [+ , 0 , -]

+ : The original value of the parameter will be the lower limit of change, and the LFO will affect the parameter only upward.

0 : The LFO will affect the parameter both upward and downward.

- : The original value of the parameter will be the upper limit of change, and the LFO will affect the parameter only downward.

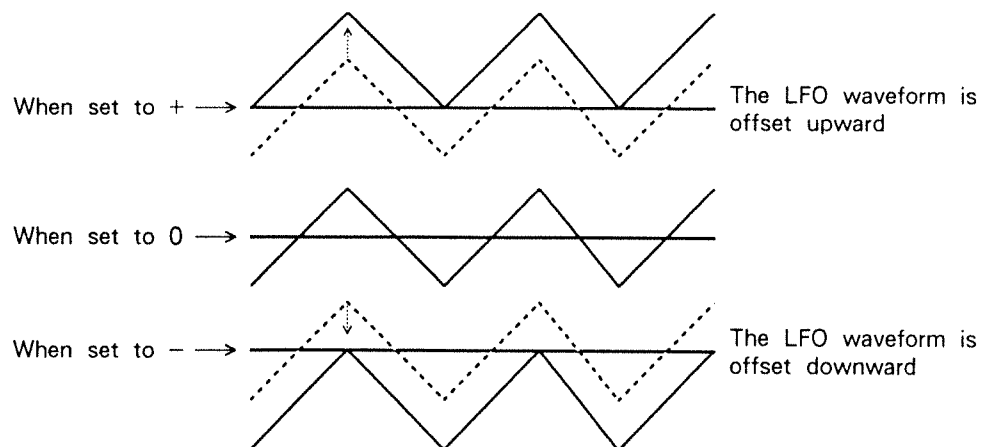

* Offset has no effect on the TVA envelope.

Sound idea

Many acoustic instruments (including the human voice) sound better if the center pitch is raised slightly when vibrato is applied. You can simulate this by setting the Offset parameter to "+".

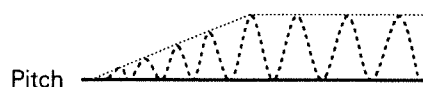

2. TONE EDIT

Tone edit/LFO 1/2/Key trigger

Key trigger This parameter determines whether or not the LFO waveform will be restarted each time you play a note.

① Press **KEY TRIG**.

When Key Trigger is on, the indicator will be lit.

```
LFO1:Key trig
▶OFF ON ON OFF
```

[Values] [ON, OFF]

ON : The LFO waveform will begin at the moment you press the key.

OFF : The same LFO waveform will continue regardless of when you press the key.

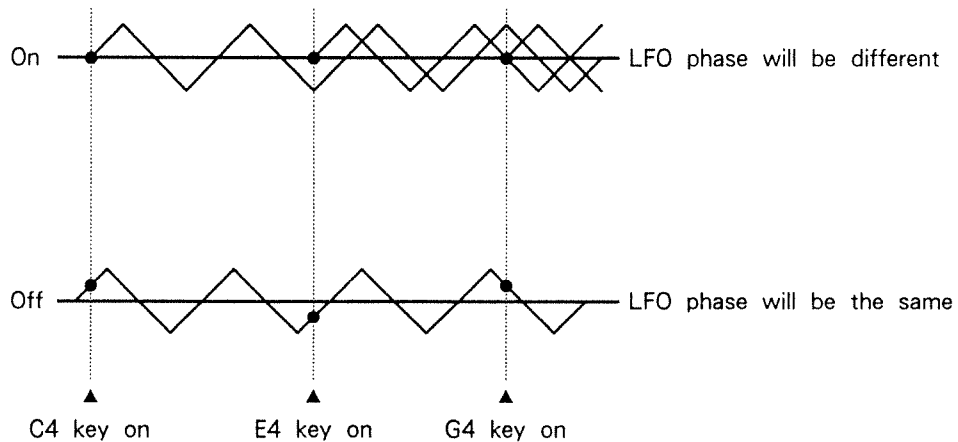

Sound idea

If you play two or more notes simultaneously when Key Trigger is on, the LFO waveform will be restarted for each note. Each note will be at a slightly different point in its LFO, creating a more spacious and richer sound.

When Key Trigger is off, all notes will always be at the same point in their LFO, resulting in a tighter sound. This may be useful when you want to emphasize the vibrato effect.

● WG

This block is where you select the waveform that is the core of the sound, and set parameters related to its pitch. (WG is an abbreviation of Wave Generator; i.e., the circuit that creates a waveform.)

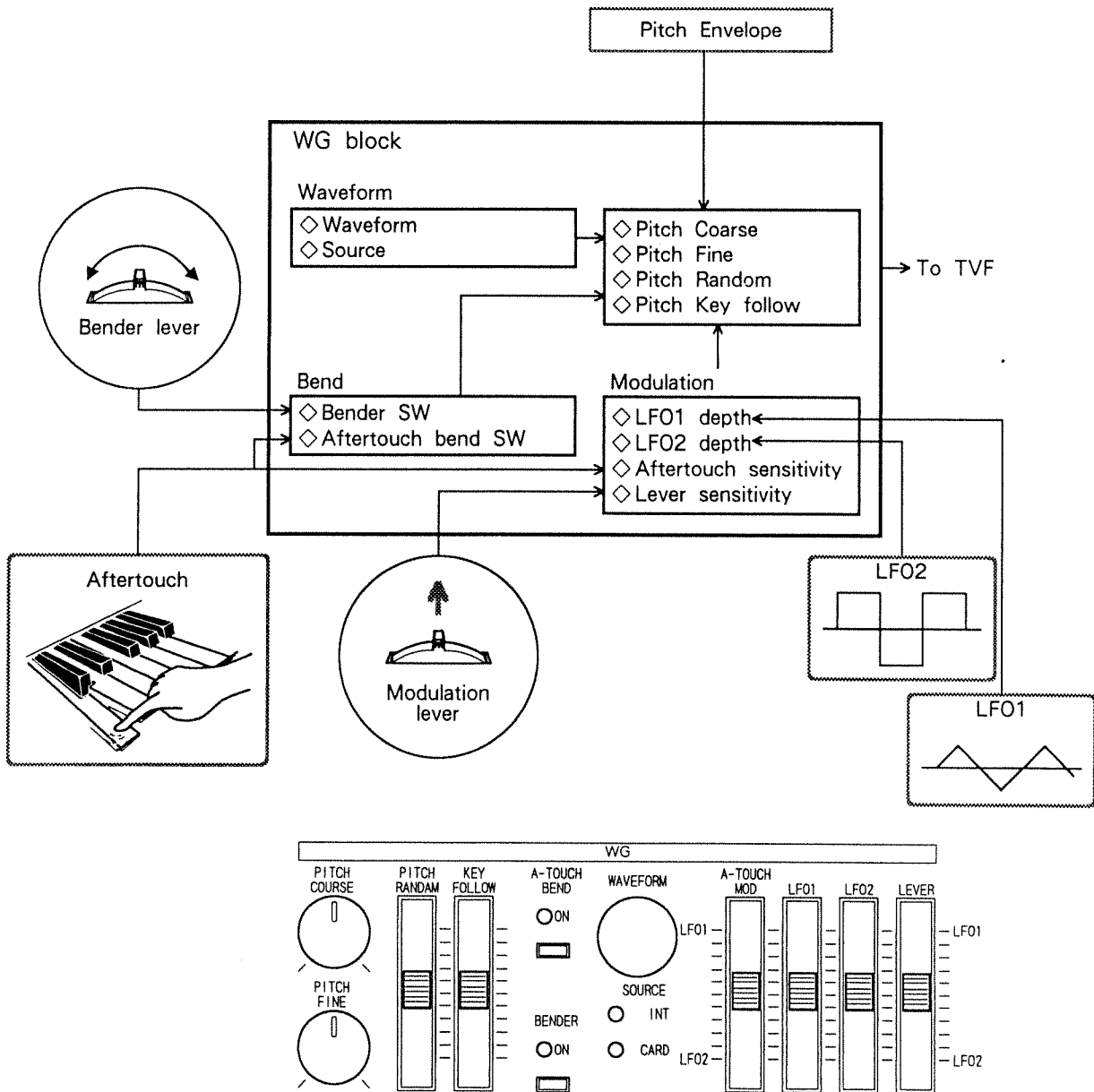

2. TONE EDIT

Tone edit / WG / Pitch coarse

○ **Pitch coarse** This parameter determines the basic pitch in chromatic steps over a range of ± 4 octaves. Use this parameter to specify the approximate pitch, and use the Pitch Fine parameter (⇨ next page) to make fine adjustments.

① Rotate the PITCH COARSE knob.

```
WG:Pitch coarse
▶00 +07 -12 +24
```

【Values】 [- 48 — + 48]

If you rotate the knob in the “+” direction (to the right), the pitch will rise up to 4 octaves. If you rotate the knob in the “-” direction (to the left), the pitch will fall by up to 4 octaves. When the knob is in the center position, the value will be 0, and the standard pitch will sound.

Sound idea

You can create rich sounds by layering two Tones with their Pitch Coarse settings one octave apart (± 12). This is known as “octave unison”.

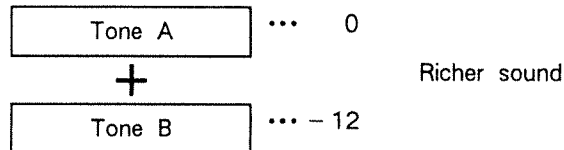

Or, you can layer four organ-type Tones and set their Pitch Coarse values to 0/+12/+19/+24 to create a jazz organ sound. If you then assign the TVA levels to the Palette, you can use the Palette sliders as the drawbars of an organ.

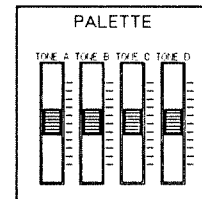
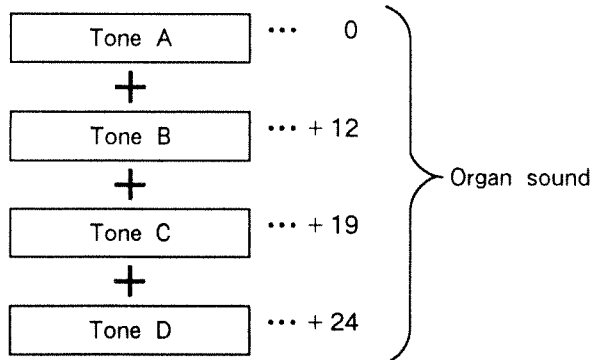

You can create a rock organ sound by setting the Pitch Coarse values to $-12/0/+7/+12$.

- **Pitch fine** This parameter is a fine adjustment (in units of 1 cent) over a range of $+/- 50$ cents, relative to the pitch specified by Pitch Coarse. Since 100 cents equals 1 chromatic step, $+/- 50$ cents allows you to adjust the pitch up or down $1/2$ of a chromatic step.

- ① Rotate the PITCH FINE knob.

```
WG:Pitch fine
+00 +02 -02 00
```

【Values】 [- 50 — + 50]

If you rotate the knob in the “+” direction (to the right), the pitch will rise up to 50 cents. If you rotate the knob in the “-” direction (to the left), the pitch will fall by up to 50 cents. When the knob is in the center position, the value will be 0, and the pitch will be as specified by Pitch Coarse.

Sound idea

You can create a rich sound by setting two layered Tones to slightly different Pitch Fine settings (about $+/- 3$ cents). This is known as “detune”.

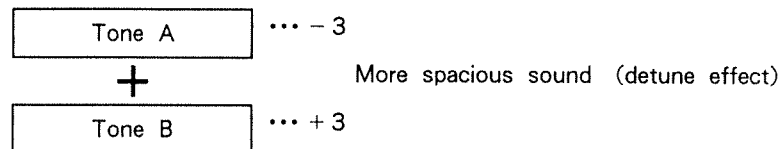

○ Pitch random

This parameter applies randomness to the pitch.

On analog synthesizers of the past, the pitch of each note was not always accurate. However, this resulted in a richness that is difficult to duplicate on the digital synthesizers of today. This Pitch Random parameter allows you to apply slight amounts of randomness to the pitch to create this effect.

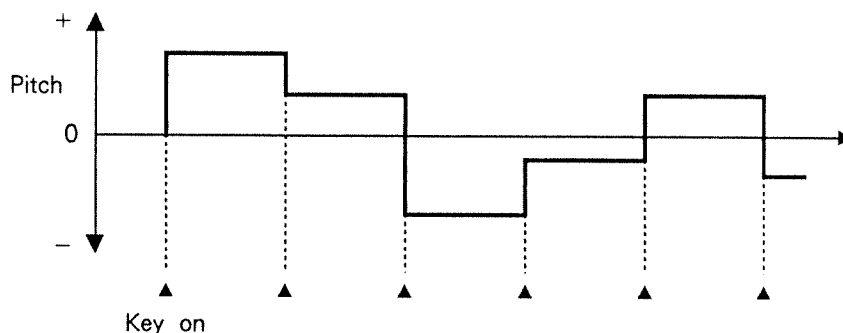

The pitch will be different each time you play the same key.

① Move **PITCH RANDOM**.

```
WG:Pitch Ranom
100 30 40 50
```

【Values】 [0—100]

As you increase the value, there will be greater random changes in pitch. For a value of 0, there will be no random pitch change.

*** Pitch Random applies a random pitch change when each note is played. If you wish to change the pitch during the duration of the note, use the Pitch Envelope (☞ P. I - 44), or make appropriate settings in the LFO block (☞ P. I - 19) and then raise the WG block **LFO 1** / **LFO 2** (☞ P. I - 41, I - 42).**

○ Pitch key follow

This parameter specifies how the pitch will change in relation to the keyboard position of the note you play.

Pianos are tuned in what is known as “stretched” tuning, in which higher octaves are actually tuned slightly further apart to make the sound more natural. This can be simulated by appropriate settings of the Pitch Key Follow parameter.

Except when you wish to create special effects, you will normally leave this parameter set to +100%.

① Move **KEY FOLLOW**.

```
WG:Pitch KF
▶100 101 50 00
```

【Values】 [- 100% — + 200]

For a value of +200%, the pitch will rise two octaves for every 12 keys (1 octave) you play upward, with the C4 key as the center. For a value of - 100%, the pitch will fall one octave for every 12 keys (1 octave) you play upward. For a setting of 0%, all keys will produce the same pitch.

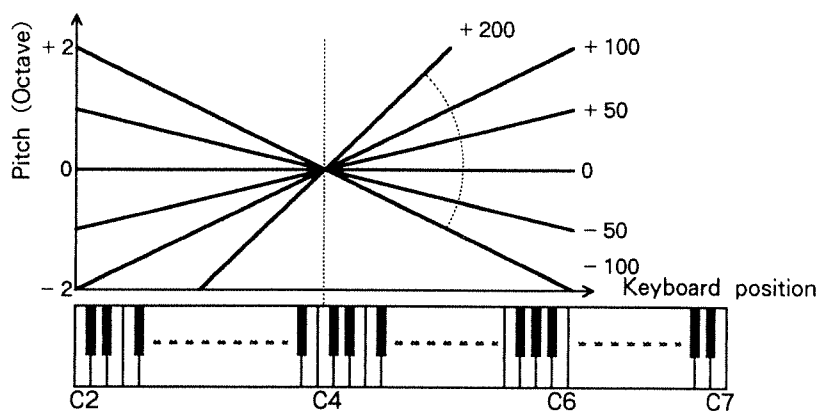

Sound idea

“Stretched” tuning can be simulated by Pitch Key Follow values of 101% or 102%. Instruments which are able to produce microtonal intervals can be simulated by Pitch Key Follow values of 10% or 20%.

○ Aftertouch bend switch

This parameter specifies whether aftertouch (pressure on the keyboard after playing a note) will affect the pitch.

***The amount of pitch change is determined by the Patch Common parameter Aftertouch Bend Sensitivity (☞ P. I – 123).**

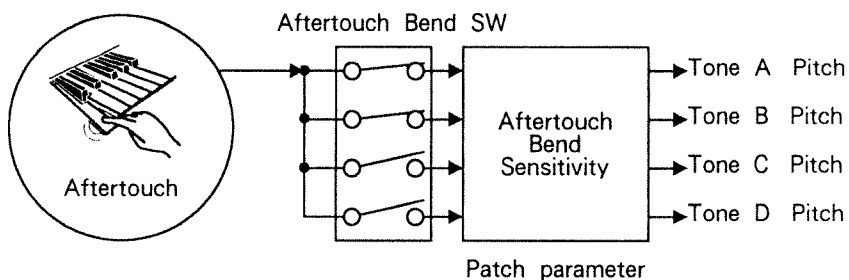

① Press **A-TOUCH BEND**.

The indicator will be lit when this parameter is on.

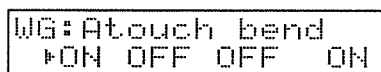

[Values] [ON, OFF]

ON : Aftertouch will affect the pitch.

OFF : Aftertouch will not affect the pitch.

***This setting also determines the effect of Aftertouch messages received from MIDI IN.**

***The MIDI Tx Aftertouch (☞ P. III – 19) setting will determine whether or not Aftertouch messages are transmitted.**

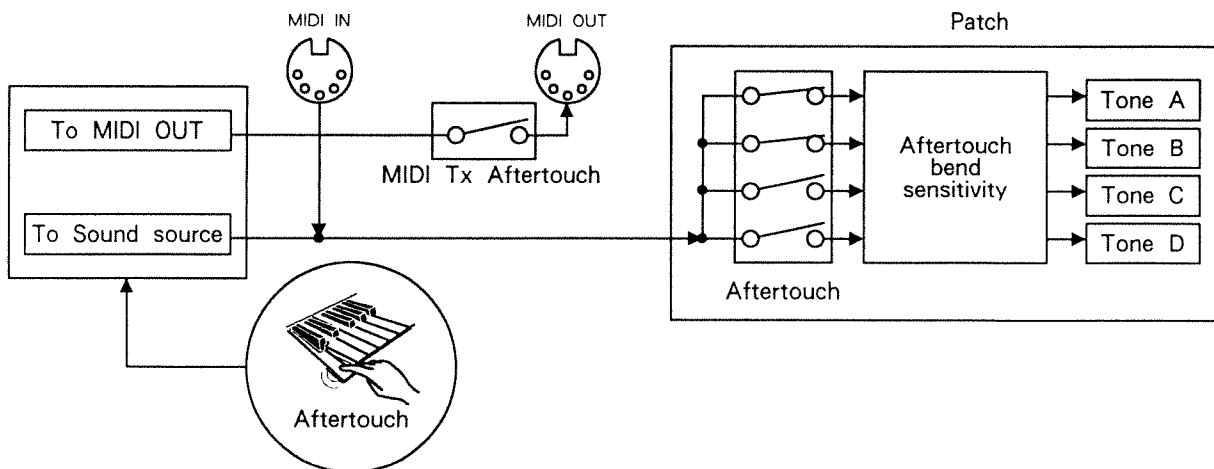

Sound idea

This parameter can be used to produce a quick drop in pitch similar to when a guitarist presses the vibrato arm down.

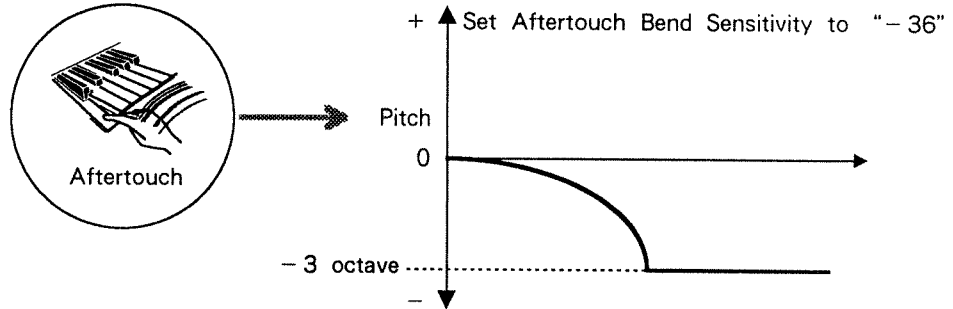
**Note**

Aftertouch can also control the following parameters.

WG A-TOUCH MOD (P. I - 39)

TVF A-TOUCH (P. I - 59)

TVA A-TOUCH (P. I - 72)

2. TONE EDIT

Tone edit / WG / Bender switch

○ Bender switch

This parameter determines whether the bender lever will affect the pitch.

*The amount of pitch change is determined by the Patch Common parameter **Bender Range** (☞ P. I - 122).

① Press **BENDER**.

The indicator will be lit when this parameter is on.

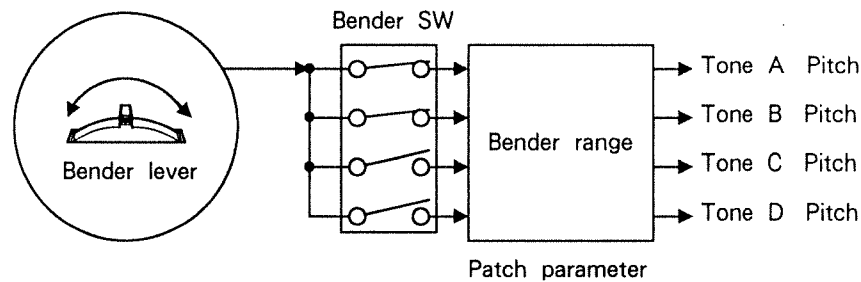

```
WG: Bender  
ON OFF OFF ON
```

【Values】 [ON, OFF]

ON : The bender lever will affect the pitch.

OFF : The bender lever will not affect the pitch.

*This setting also determines the effect of Pitch Bend messages received from MIDI IN.

*Pitch Bend messages will be transmitted from MIDI OUT regardless of this setting.

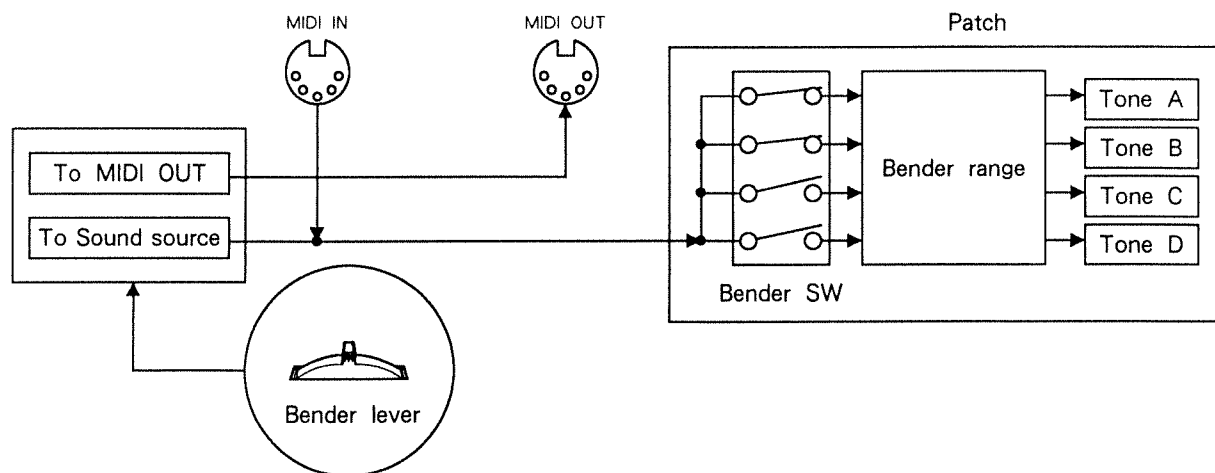

Sound idea

By using two Tones and disabling the Bender Switch for one of the Tones, you can simulate guitar performance techniques such as “harmonized bending” (bending one string to make two strings produce the same pitch).

| | |
|--------|-------------------------------------|
| Tone A | Pitch coarse : 0 Bender SW : off |
|--------|-------------------------------------|

+

| | |
|--------|-------------------------------------|
| Tone B | Pitch coarse : -2 Bender SW : on |
|--------|-------------------------------------|



Bender range U : 2

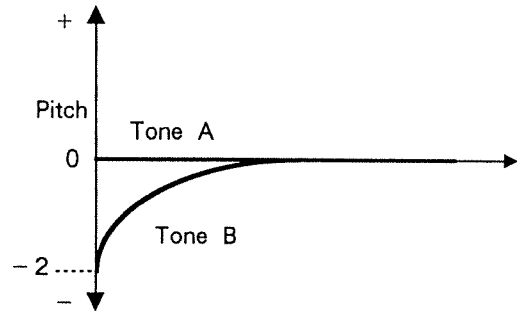

2. TONE EDIT

Tone edit/WG/Waveform

- **Waveform** This parameter selects the waveform that is the core of the sound. It is the most important parameter in determining the fundamental sound character.

① Rotate the WAVEFORM knob.

Rotate the knob to the right to select a higher waveform number, and to the left to select a lower waveform number. If there is only one active Tone, the wave number and name of that Tone will be displayed.

Example) only Tone A is active

WG:Waveform(A)
I-001:Syn Saw 1

This indicates the active Tone.

If all Tones are inactive, or if two or more Tones are active, the wave number for four Tones, will be displayed.

Example) Tones B/C/D are active

WG:Waveform
001+001+098+108

Active On

【Values】 [001—108]

The number of waveforms will depend on the source (internal or card) you have selected. The internal memory of the JD-800 contains 108 waveforms.

* By setting only one Tone to Active On, you can check the name of the wave used by that Tone.

* The value of this parameter cannot be modified using the Palette.

The internal memory of the JD-800 contains the following waveforms.

| Wave number | Wave name | Explanation | Wave number | Wave name | Explanation | Wave number | Wave name | Explanation | Wave number | Wave name | Explanation |
|-------------|------------|---------------------------------|-------------|------------|----------------------------------|-------------|------------|-------------------|-------------|------------|-------------------------------|
| 001 | Syn Saw 1 | Distinctive analog synth sounds | 028 | Digiwave | Distinctive digital synth sounds | 055 | Tabla | Percussive sounds | 082 | Cowbell | Fast attack (One-shot) sounds |
| 002 | Syn Saw 2 | | 029 | Can Wave 1 | | 056 | Pole Ip | | 083 | Sm Metal | |
| 003 | FAT Saw | | 030 | Can Wave 2 | | 057 | Pluck Harp | | 084 | StrikePole | |
| 004 | FAT Square | | 031 | EML 5th | | 058 | Nylon Str | | 085 | Pizz | |
| 005 | Syn Pulse1 | | 032 | Wave Scan | | 059 | Hooky | | 086 | Switch | |
| 006 | Syn Pulse2 | | 033 | Nasty | | 060 | Muters | | 087 | Tuba Slap | |
| 007 | Syn Pulse3 | | 034 | Wave Table | | 061 | Klack Wave | | 088 | Plink | |
| 008 | Syn Pulse4 | | 035 | Fine Wine | | 062 | Crystal | | 089 | Plunk | |
| 009 | Syn Pulse5 | | 036 | Funk Bass1 | | 063 | Digi Bell | | 090 | EP Atk | |
| 010 | Pulse Mod | | 037 | Funk Bass2 | | 064 | FingerBell | | 091 | TVF_Trig | |
| 011 | Triangle | | 038 | Strat Sust | | 065 | Digi Chime | | 092 | Flute Tone | |
| 012 | Syn Sine | 039 | Harp Harm | 066 | Bell Wave | 093 | Pan Pipe | | | | |
| 013 | Soft Pad | 040 | Full Organ | 067 | Org Bell | 094 | BottleBlow | | | | |
| 014 | Wire Str | 041 | Full Draw | 068 | Scrape Gut | 095 | Shaku Atk | | | | |
| 015 | MIDI Clav | 042 | Doo | 069 | Strat Atk | 096 | FlugelWave | | | | |
| 016 | Spark Vox1 | 043 | ZZZ Vox | 070 | Hellow Bs | 097 | French | | | | |
| 017 | Spark Vox2 | 044 | Org Vox | 071 | Piano Atk | 098 | WhiteNoise | | | | |
| 018 | Syn Sax | 045 | Male Vox | 072 | EP Hard | 099 | Pink Noise | | | | |
| 019 | Clav Wave | 046 | Kalimba | 073 | Clear Keys | 100 | Pitch Wind | | | | |
| 020 | Cello Wave | 047 | Xylo | 074 | EP Distone | 101 | Vox Noise1 | | | | |
| 021 | BrightDigi | 048 | Marim Wave | 075 | Flute Push | 102 | Vox Noise2 | | | | |
| 022 | Cutters | 049 | Log Drum | 076 | Shami | 103 | CrunchWind | | | | |
| 023 | Syn Bass | 050 | AgogoBells | 077 | Wood Crak | 104 | ThroatWind | | | | |
| 024 | Rad Hose | 051 | Bottle Hit | 078 | Kimba Atk | 105 | Metal Wind | | | | |
| 025 | Vocal Wave | 052 | Gamelan 1 | 079 | Block | 106 | Windago | | | | |
| 026 | Wally Wave | 053 | Gamelan 2 | 080 | Org Atk 1 | 107 | Anklungs | | | | |
| 027 | Brusky Ip | 054 | Gamelan 3 | 081 | Org Atk 2 | 108 | Wind Chime | | | | |
| | | | | | | | | | | | Special effect |

If you have inserted a WAVEFORM card (SO-JD80 series, sold separately) into the WAVEFORM slot, you can press **SOURCE** to select waveforms from the card as well.

Sound idea

Selecting a waveform is the single most important decision when creating a sound. Imagine the type of sound you want to create, and then select an appropriate waveform.

The following waveforms are suitable for common instruments.

Strings → 001—003, 010, 014 etc.

Brass → 001—003, 086, 097 etc.

Piano → 071

2. TONE EDIT

Tone edit/WG/Source

Source Specify whether the waveform will be selected from internal memory or from a WAVEFORM card.

① Press **SOURCE**.

Each time you press the button, the indicator will alternate between INT and CARD.

```
WG: Wave source
▶INT INT INT CRD
```

[Values] [INT, CRD]

INT : Select a waveform from internal memory.

CRD : Select a waveform from a WAVEFORM card.

***If a WAVEFORM card has not been inserted into the WAVEFORM card slot, the following display will appear when you press **SOURCE**, and you will not be able to select CARD.**

```
WAVEFORM card
is not ready
```

Note: How to use a WAVEFORM card

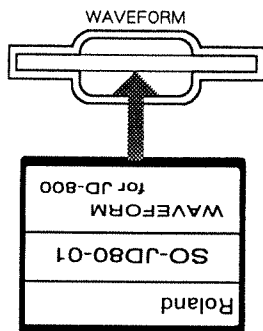

As shown in the illustration above, insert the WAVEFORM card (SO-JD80 series) firmly into the WAVEFORM card slot. The number of waveforms a card contains will be different for each card. For details, refer to the included manual.

***The appearance of the card will differ from the illustration.**

○ **Aftertouch modulation sensitivity**

This parameter determines how aftertouch will control vibrato depth; i.e., the depth of the vibrato that will be applied in response to maximum aftertouch pressure. Appropriate settings of this parameter allow you to add musically expressive vibrato.

① Move **A-TOUCH MOD**.

The lower half of the slider range allows aftertouch to bring in LFO2, and the upper half of the slider range allows aftertouch to bring in LFO1.

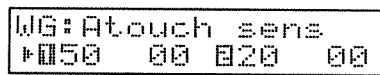

▣ indicates LFO1, ▤ indicates LFO2.

【Values】 [**2**50—0—**1**50]

When this parameter is set to an LFO1 value, maximum aftertouch will result in vibrato being applied as you specified in the LFO1 block. For an LFO2 value, the LFO2 block will be used in the same way.

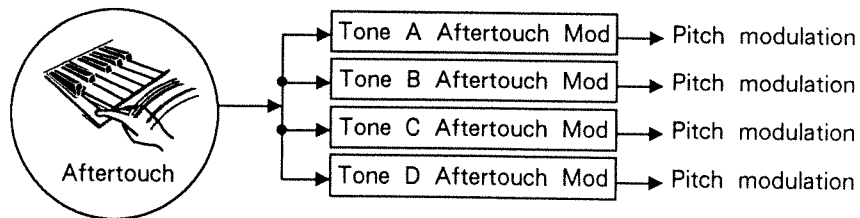
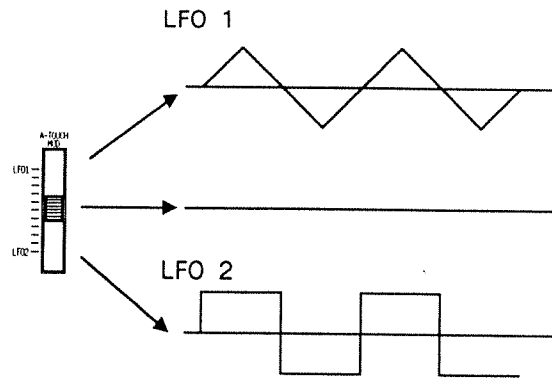

2. TONE EDIT

Tone edit / WG / Aftertouch modulation sensitivity

* If **LFO1** / **LFO2** (☞ P. I - 41, I - 42) are set to a value of other than 0, the vibrato brought in by aftertouch will simply be added to that vibrato. This means that if you want vibrato to occur only when you apply aftertouch pressure, you must set **LFO1** / **LFO2** to 0.

* This setting also determines the effect of Aftertouch messages received from MIDI IN.

* The MIDI Tx Aftertouch (☞ P. III - 19) setting will determine whether or not Aftertouch messages are transmitted.

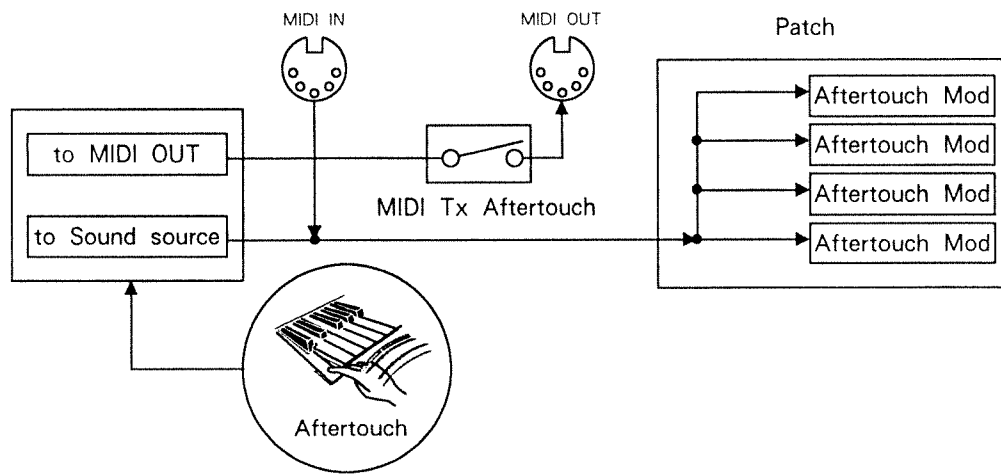

Sound idea

This parameter can be used to make synth solos more expressive.

Note

The following parameters can also be controlled by aftertouch.

WG A-TOUCH BEND (☞ P. I - 32)

TVF A-TOUCH (☞ P. I - 59)

TVA A-TOUCH (☞ P. I - 72)

○ LFO 1 modulation depth

This parameter determines the depth of the vibrato applied by LFO1. The LFO waveform you selected in the LFO1 block will modulate the pitch to create vibrato. This parameter determines the depth and polarity of the vibrato. The vibrato you set here will always be applied.

① Move **LFO1**.

```
WG:LFO1 depth
+50 00 -20 00
```

【Values】 [- 50 — + 50]

Positive (+) values will create vibrato using the waveform you selected for LFO1. Negative (-) values will create vibrato using the inverse of the waveform you selected for LFO1. At a settings of 0, there will be no vibrato.

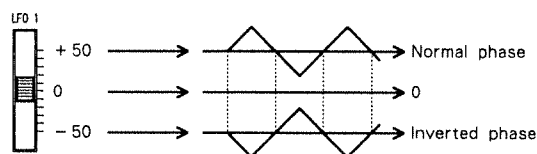

*** If you want vibrato to occur only when you move the modulation lever or aftertouch, set this parameter to 0. Then set Lever Modulation Sensitivity (☐ P. I - 43) or Aftertouch Modulation Sensitivity (☐ P. I - 39).**

Sound idea

By using two layered Tones and setting this parameter to opposite settings for each Tone (for example - 30 and +30), you can create unique vibrato effects in which the pitch changes in opposite directions.

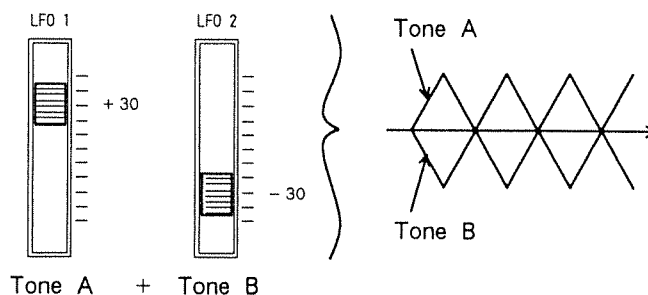

2. TONE EDIT

Tone edit/WG/LFO 2 modulation depth

○ LFO2 modulation depth

This parameter determines the depth of the vibrato applied by LFO2. The LFO waveform you selected in the LFO2 block will modulate the pitch to create vibrato. This parameter determines the depth and polarity of the vibrato. The vibrato you set here will always be applied.

① Move **LFO2**.

```
WG:LFO2 depth
+50 00 -20 00
```

【Values】 [- 50 — + 50]

Positive (+) values will create vibrato using the waveform you selected for LFO2. Negative (-) values will create vibrato using the inverse of the waveform you selected for LFO2. At a setting of 0, there will be no vibrato.

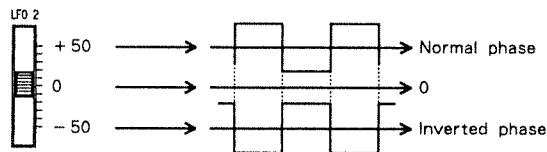

* If you want vibrato to occur only when you move the modulation lever or aftertouch, set this parameter to 0. Then set Lever Modulation Sensitivity (⇨ P. I - 43) or Aftertouch Modulation Sensitivity (⇨ P. I - 39).

Sound idea

By setting LFO1 and LFO2 to different waveforms and making appropriate depth adjustments, you can create very complex vibrato effects.

○ Lever modulation sensitivity

This parameter determines the depth of the vibrato applied by the modulation lever.

By using the modulation lever to make subtle changes in vibrato depth, you can add expressive nuances to your performance.

① Move **LEVER**.

The lower half of the slider range allows the modulation lever to bring in LFO2, and the upper half of the slider range allows the modulation lever to bring in LFO1.

WG: Lever sens □ indicates LFO1, and ▣ indicates LFO2.

```

+050  00 020  00
  
```

【Values】 [**2** 50—0— **1** 50]

If this is set in the direction of LFO 2, pushing the modulation lever away from you will cause vibrato to be applied using the LFO 2 waveform. When this parameter is set to an LFO1 value, moving the modulation lever will result in vibrato being applied as you specified in the LFO1 block.

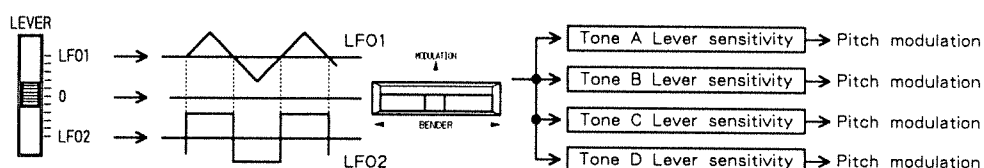

* The bender/modulation lever can control only pitch. It cannot control cutoff frequency or volume level.

* If the **LFO1** / **LFO2** modulation depth (P. I - 41, I - 42) is set to a value other than 0, the vibrato brought in by the modulation lever will simply be added to that vibrato. This means that if you want vibrato to occur only when you move the modulation lever, you must set **LFO1** / **LFO2** modulation depth to 0.

* When modulation messages are received from MIDI IN, vibrato will be applied according to these settings.

● Pitch envelope

This block lets you specify how the pitch produced by the WG will change over time.

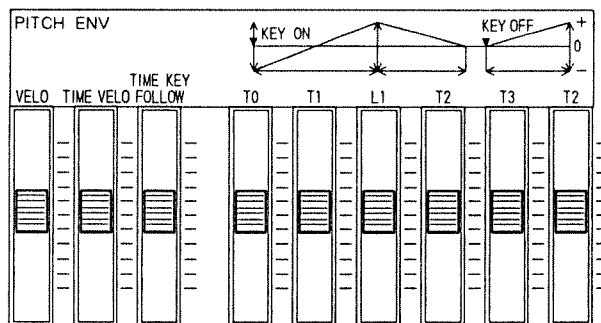
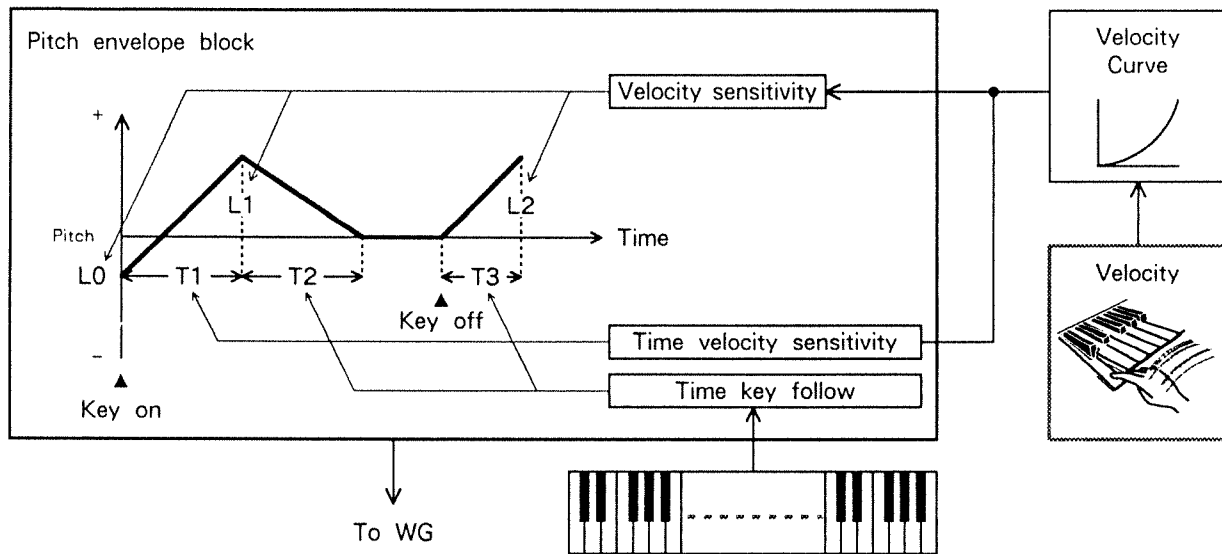

○ Velocity sensitivity

This parameter determines how the levels L0, L1, and L2 of the pitch envelope will be affected by velocity. The pitch envelope will be different for notes played with different velocities.

① Move **VELO**.

```
P-ENV:Velo
+00 +50 -50 00
```

[Values] [- 50 — + 50]

For positive (+) values, higher velocities will make the pitch envelope change more greatly. For negative (-) values, higher velocities will cause less of a change. For a value of 0, velocity will have no effect on the pitch envelope levels.

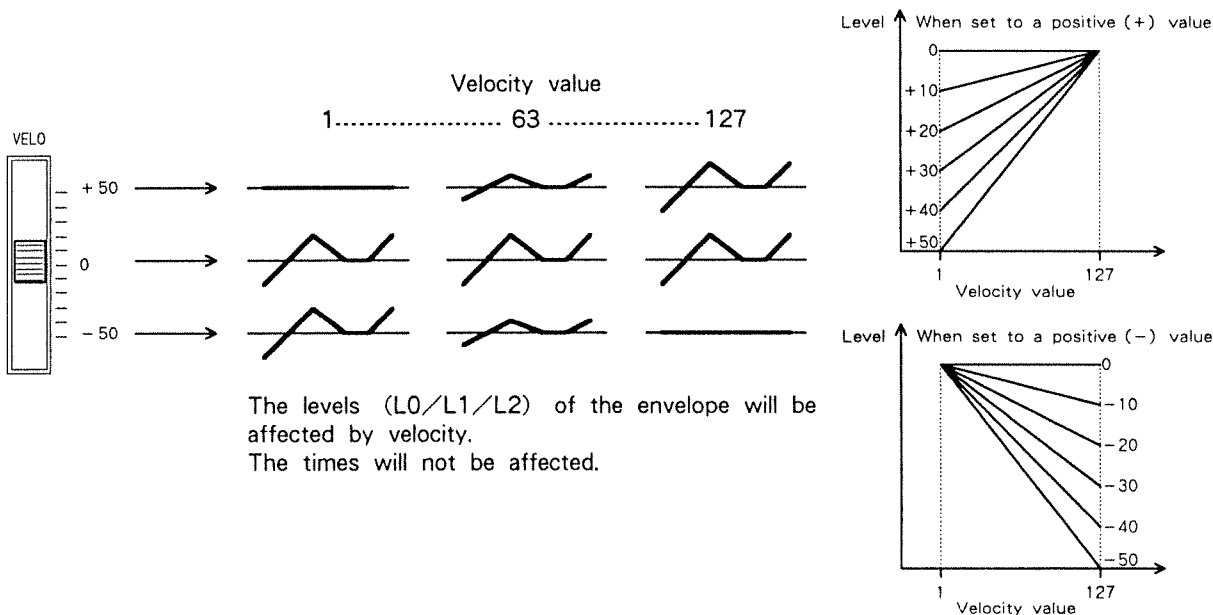

The levels (L0/L1/L2) of the envelope will be affected by velocity.
The times will not be affected.

* The resulting pitch envelope levels will not exceed the levels you specify in **L0** / **L1** / **L2**.

Sound idea

In brass instruments such as a trumpet, there is a natural unsteadiness in pitch at the beginning of each note. This unsteadiness is also affected by the force with which the note is played. This can be simulated by setting this Velocity Sensitivity parameter to a value of approximately +50. Softly played notes will not have very much pitch change, but strongly played notes will have greater pitch change.

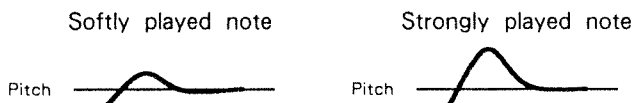

2. TONE EDIT

Tone edit/Pitch envelope/Time velocity sensitivity

○ Time velocity sensitivity

This parameter determines how the T1 of the pitch envelope will be affected by velocity. The pitch envelope will be different for notes played with different velocities.

① Move **TIME VELO**.

```
P-ENV:Time velo
+00 +50 -50 00
```

【Values】 [- 50— + 50]

For positive (+) values, higher velocities will make the attack time of pitch envelope change more quickly. For negative (-) values, higher velocities will make the attack time of pitch envelope change more slowly. For a value of 0, velocity will have no effect on the pitch envelope times.

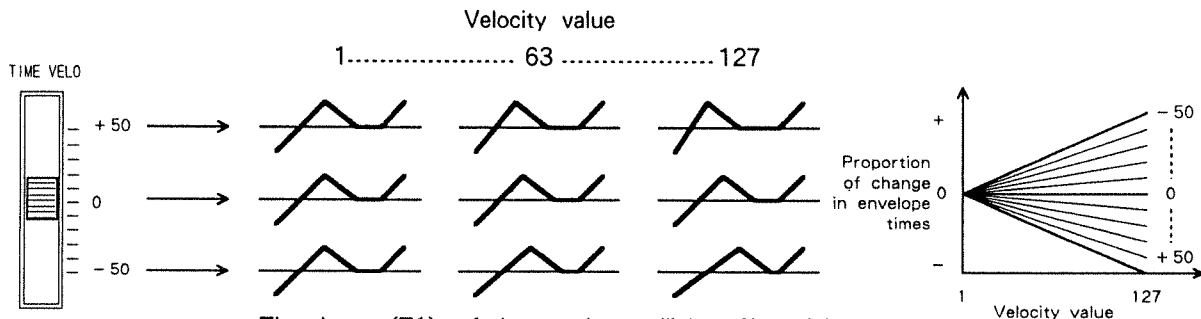

The times (T1) of the envelope will be affected by velocity.
The levels will not be affected.

* Velocity values are processed through the velocity curve (☞ P. I - 17) before being applied to this parameter.

Sound idea

If this parameter is set to a value of approximately +50, softly played notes will change slowly in pitch, and strongly played notes will change rapidly in pitch. This can be useful when creating sound effects, etc.

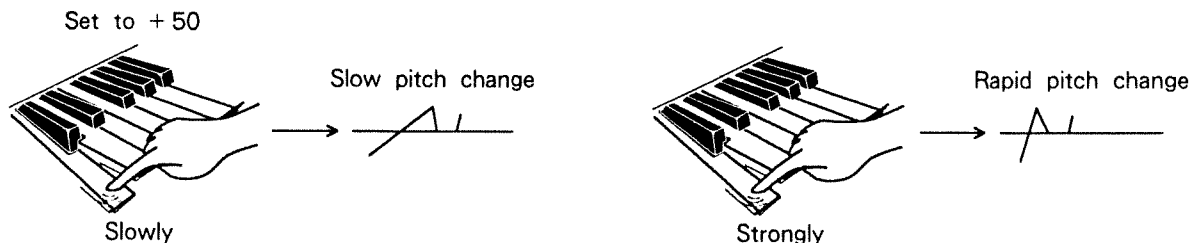

○ Time key follow

This parameter determines how the T2 and T3 of pitch envelope will be affected by keyboard position. The pitch envelope will be different for notes played in different areas of the keyboard.

① Move **TIME KEY FOLLOW**.

```
P-ENV:Time KF
+00 +10 -10 00
```

[Values] [- 10— + 10]

For positive (+) values, decay and release time of pitch envelope will be shorter for higher notes (toward the right side of the keyboard). For negative (–) values, decay and release time of pitch envelope will be longer for higher notes. For a setting of 0, the pitch envelope times will be the same for all notes, regardless of the keyboard area.

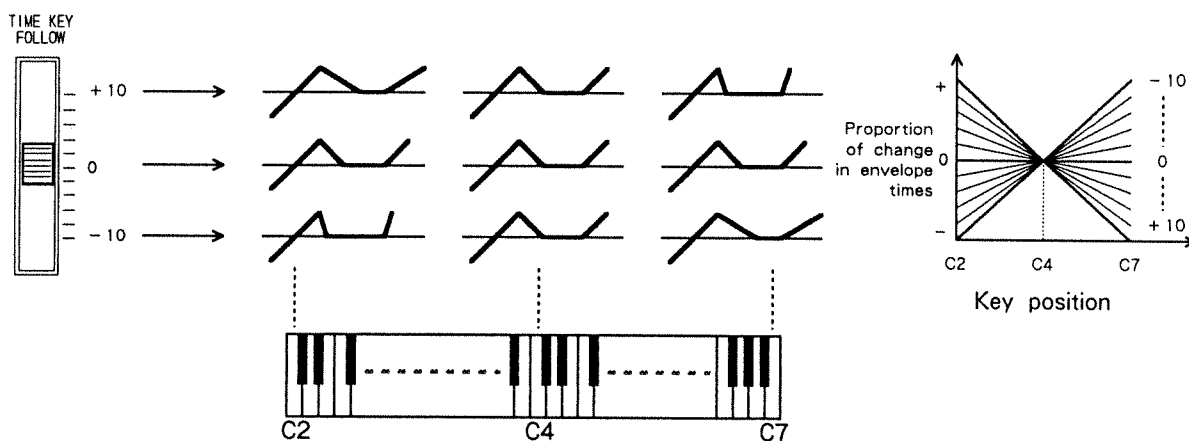

The times (T2/T3) of the envelope will be affected by keyboard position.
The levels will not be affected.

*** Key Follow takes effect around the C4 key. In other words, the values of the pitch envelope will change as you play above (or below) the center key of C4.**

Sound idea

On most acoustic instruments, higher notes have a shorter decay. By setting the Time Key Follow parameter to a positive (+) value, you can simulate this by making the pitch change more quickly for higher notes.

2. TONE EDIT

Tone edit/Pitch envelope/Level 0/1/2

○ Level 0/1/2

These parameters specify Levels 0/1/2 of the pitch envelope. These determine the amount of pitch change that will occur at each point in the pitch envelope. These values are relative to the "standard pitch" determined by the values of the Pitch Coarse (P. I - 28), Pitch Fine (P. I - 29), and Pitch Key Follow (P. I - 31) parameters.

① Move **L0/L1/L2**.

```
P-ENU:Level 0  
+10 -10 +30 -50
```

```
P-ENU:Level 1  
+10 -10 +30 -50
```

```
P-ENU:Level 2  
+10 -10 +30 -50
```

【Values】 [-50—+50]

Positive values will raise the pitch up to 1 octave above the standard pitch. Negative values will lower the pitch up to 3 octaves below the standard pitch. For a value of 0, the pitch will remain at the standard pitch.

*** If Velocity Sensitivity is other than 0, the pitch envelope levels you set here will be affected by velocity.**

*** The settings you make over the range of +/- 50 will follow the curve shown below.**

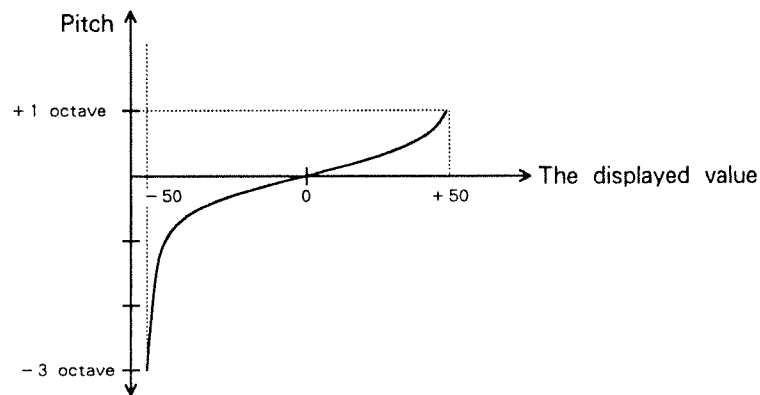

○ Time 1/2/3

These parameters specify Times T1, T2, T3 of the pitch envelope. These determine the time over which the pitch will change from one pitch level to the next (for example, from L0 to L1).

① Move **T1** / **T2** / **T3**.

```
P-ENV:Time 1
▶10 10 30 50
```

```
P-ENV:Time 2
▶10 10 30 50
```

```
P-ENV:Time 3
▶10 10 30 50
```

【Values】 [0—100]

Higher values will result in a longer time before the next level is reached.

* If the Time Velocity Sensitivity value is other than 0, velocity will affect the time of T1.

* If the Time Key Follow value is other than 0, key position will affect the times of T2 and T3.

* The following chart shows how the parameter values correspond to actual time.

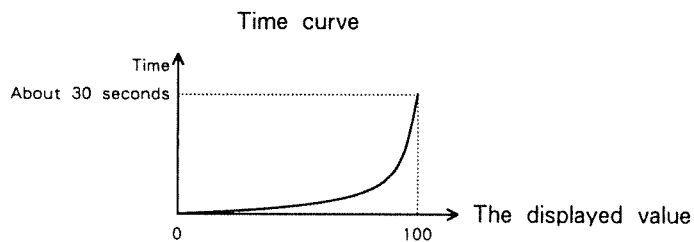

● TVF

TVF stands for Time Variant Filter; i.e., a filter that changes over time. Filters allow you to modify the tone color by cutting specified frequency areas to affect the sound's brightness or thickness.

In this block you can set parameters such as filter type and cutoff frequency, to modify the sound produced by the WG and pitch envelope.

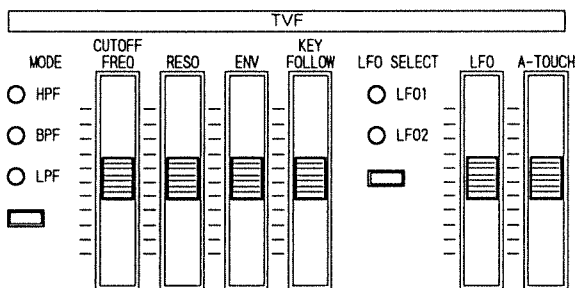
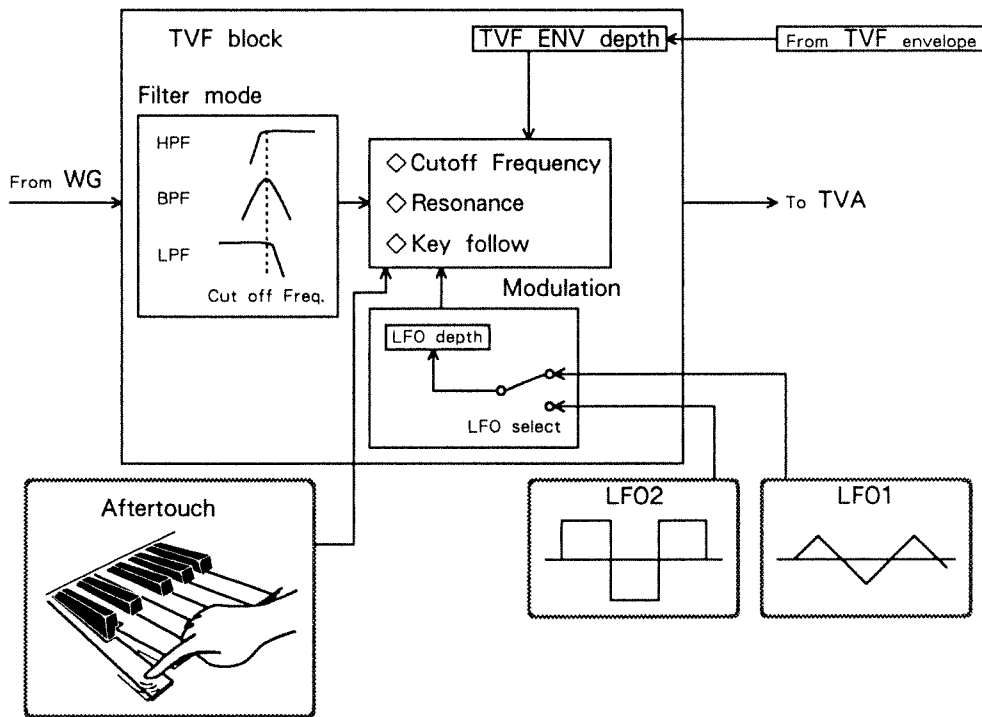

- **Filter mode** This parameter selects the type of filter.
A filter is a type of tone control, and cuts (removes) a specified range of frequencies from the original signal. The Filter Mode parameter determines whether the filter will be a Low Pass Filter, a Band Pass Filter, or a High Pass Filter.

- ① Press **MODE** to select either LPF, BPF, or HPF.

The indicator will light to indicate the selected filter type.

```

TVF: Mode
▶LPF LPF BPF HPF

```

【Values】 [HPF, BPF, LPF]

HPF : A High Pass Filter is a filter that allows the sound above the cutoff frequency to pass (and removes the sound below the cutoff frequency). This filter is especially useful when creating percussive sounds where the characteristic elements are in the higher frequency ranges.

BPF : A Band Pass Filter is a filter that allows the sound in the area of the cutoff frequency to pass (and removes higher and lower sound). It is useful when creating sounds with a strong character.

LPF : A Low Pass Filter is a filter that allows the sound below the cutoff frequency to pass (and removes the sound above the cutoff frequency). This is probably the most frequently used type of filter. When the higher frequencies are cut, the sound will become darker (more mellow).

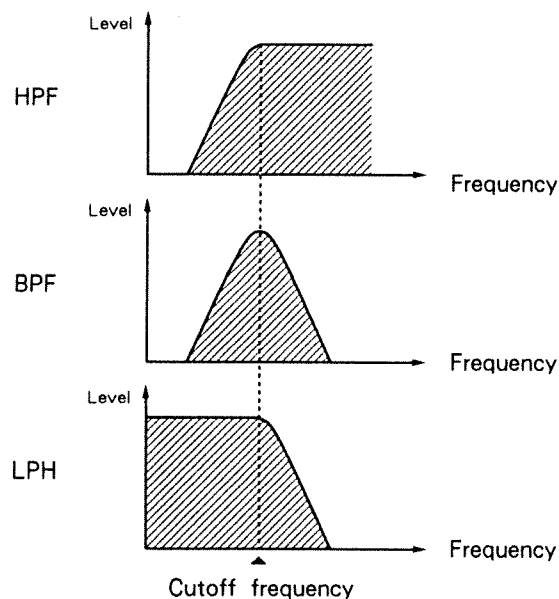

2. TONE EDIT

Tone edit / TVF / Cutoff frequency

○ Cutoff frequency

This parameter specifies the cutoff frequency of the filter.

The cutoff frequency determines the point at which the filter will start cutting these partials.

① Move **CUTOFF FREQ.**

```
TVF:Cutoff freq
▶60 60 30 80
```

【Values】 [0—100]

Higher values will result in a higher cutoff frequency.

《When using a Low Pass Filter》

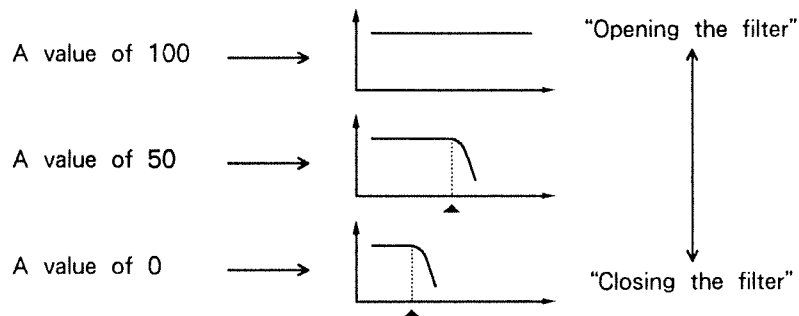

When using a Low Pass Filter, raising the cutoff frequency is sometimes called "opening the filter", and lowering the cutoff frequency "closing the filter".

Sound idea

- ◇ If the filter has been set to HPF, higher cutoff frequency values will decrease the lower partials of the spectrum, causing the sound to become harder or brighter. Depending on the waveform, high cutoff frequency values may result in no sound if the selected waveform does not contain any partials in the frequency range that is allowed to pass.

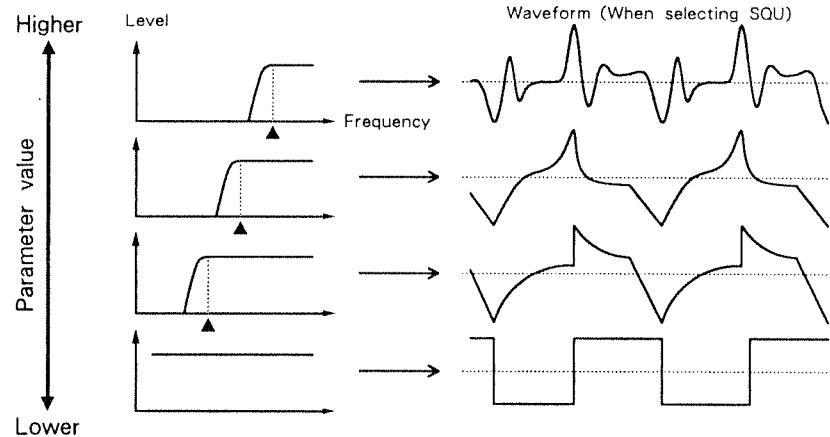

- ◇ If the filter has been set to BPF, only the partials in the area of the cutoff frequency will be allowed to pass. Depending on the waveform, high cutoff frequency values may result in no sound if the waveform does not contain any partials in the frequency range that is allowed to pass.

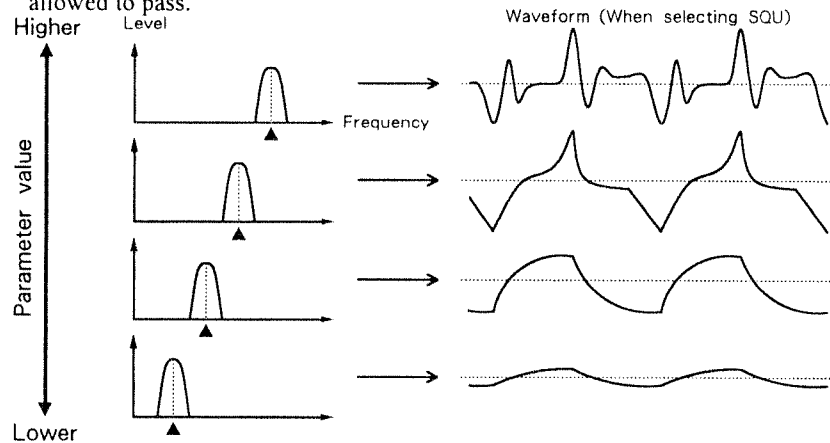

- ◇ If the filter has been set to LPF, lower cutoff frequency values will decrease the higher partials of the spectrum, causing the sound to become darker, and lower in volume.

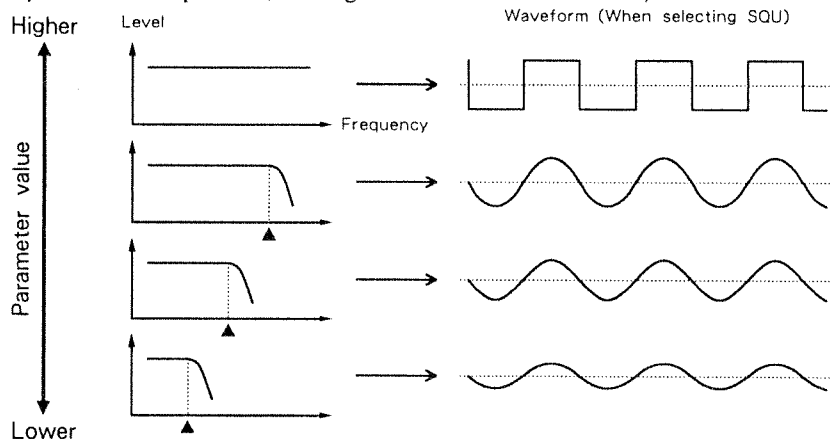

2. TONE EDIT

Tone edit / TVF / Resonance

- **Resonance** This parameter gives the sound a stronger “character”. Resonance boosts the partials in the area of the cutoff frequency, thus creating a more “peaky” sound. Appropriate values of this parameter can create sounds that are characteristic of analog synthesizers of the past.

① Move **RESO**.

```
TVF:Resonance
▶30 40 50 100
```

[Values] [0—100]

Higher values will result in a greater resonance effect.

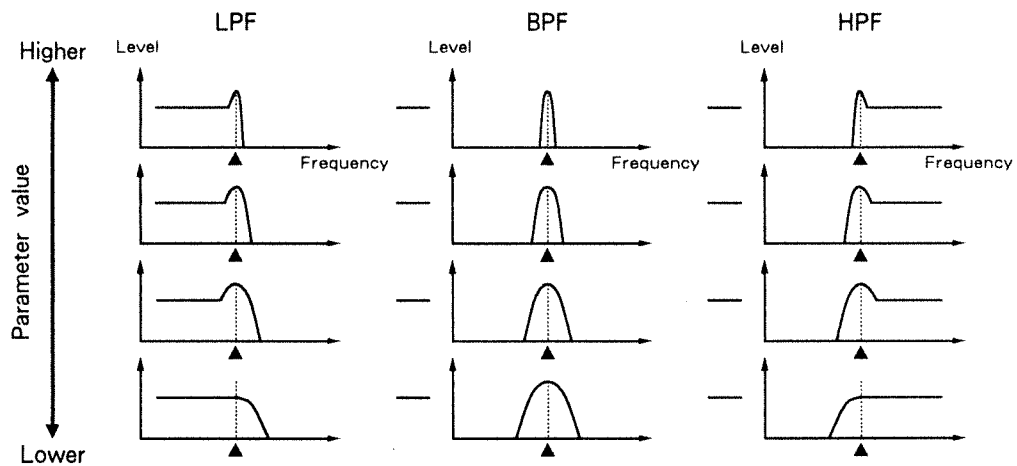

* At excessively high values (over 100) oscillation may occur, causing distortion.

Sound idea

When creating synth bass sounds, higher settings of Resonance will create a more distinctive sound.

○ TVF envelope depth

This parameter determines the depth of the TVF envelope; i.e., how the cutoff frequency will change.

① Move **ENV**.

```
TVF:ENV depth
+50 +30 -30 +50
```

【Values】 [- 50 — + 50]

For positive (+) values, the TVF envelope will affect the cutoff frequency. For negative (-) values, the inverse of the TVF envelope will affect the cutoff frequency. For a value of 0, there will be no TVF envelope, and the cutoff frequency will not change.

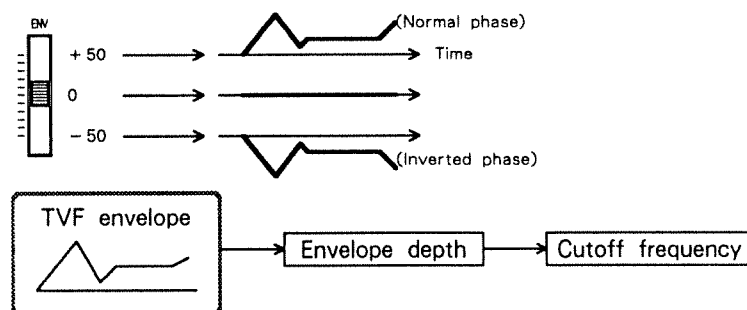

Sound idea

To understand the effect of the TVF envelope, when setting depth to “+”, you should set a lower cutoff frequency and when setting “depth” to “ - ” you should set a higher cutoff frequency.

* The sound will not be changed in the following cases:

- Cutoff frequency is set to 100 and the TVF envelope’s depth is set to “+”.
- Cutoff frequency is set to 0 and the TVF envelope’s depth is set to “ - ”.

2. TONE EDIT

Tone edit / TVF / Cutoff key follow

○ Cutoff key follow

This parameter specifies how the cutoff frequency will be adjusted according to keyboard position. On an acoustic instrument, high and low notes differ in tone color. This Cutoff Key Follow parameter can be used to simulate this by adjusting the cutoff frequency according to the keyboard position.

① Move **KEY FOLLOW**.

```
TUF:Cutoff KF  
+100 60 -50 00
```

【Values】 [- 100% — + 150%]

For a value of 150%, the cutoff frequency will move upward 1.5 octaves as you play 12 notes (1 octave) higher. For a value of - 100%, the cutoff frequency will move downward 1 octave as you play 12 notes (1 octave) higher. (In both cases, the cutoff frequency will change relative to the C4 key.) For a value of 0%, the cutoff frequency will be the same for all notes.

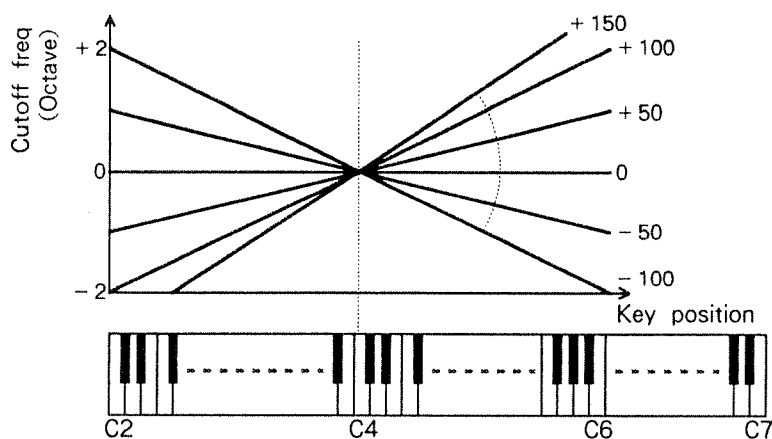

* For extreme values (positive or negative), there may be no sound at the upper or lower ends of the keyboard.

Sound idea

- ◇ On an acoustic piano, the sound gradually becomes less complex as you play higher notes. This can be simulated by a Cutoff Key Follow value of about 60%.
- ◇ When creating sound effects, it is possible to set high values for Cutoff Key Follow so that no sound is heard at the upper or lower end of the keyboard. This can be used in a way similar to TVA Bias (☞ P. I - 71).



○ LFO modulation select

This parameter selects the LFO that will modulate the cutoff frequency.

By using the LFO to modulate the cutoff frequency, you can create cyclically repeating changes in tone; “wah-wah” or “growl” effects. The amount of effect produced by the LFO is determined by the following parameter (LFO Modulation Depth).

① Press **LFO SELECT**.

The indicator of the selected LFO will light.

TUF:LFO select.  indicates LFO1,  indicates LFO2.

【Values】 [**1**, **2**]

1 : The cutoff frequency will be modulated by LFO1.

2 : The cutoff frequency will be modulated by LFO2.

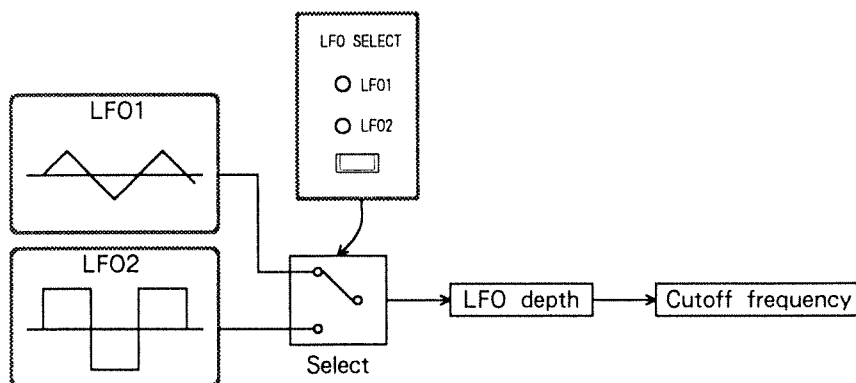

○ LFO modulation depth

This parameter specifies how deeply the LFO will affect the cutoff frequency. By setting the width (the amount of change in cutoff frequency) and polarity, you can specify the depth of the wah-wah effect.

① Move **LFO**.

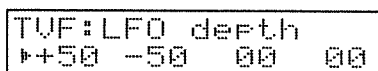

【Values】 [- 50 — + 50]

For positive (+) values, the cutoff frequency will be modulated in the shape of the waveform selected for the LFO. For negative (-) values, the cutoff frequency will be modulated in the inverse of the waveform selected for the LFO. For a value of 0, modulation will not be applied.

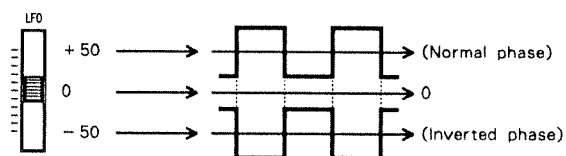

*If you want to create only a wah-wah effect, set the other LFO depth values (Pitch P. I - 41, I - 42, Level P. I - 74) to 0.

○ Aftertouch cutoff sensitivity

This parameter specifies how aftertouch (pressure after playing a note) will affect the cutoff frequency.

Depending on the value of this parameter, aftertouch can be used to make the sound brighter or darker. For example, at a value of +50, the sound will gradually become brighter as you apply more aftertouch pressure.

① Move **A-TOUCH**.

The lowest slider position will set a value of -50 , and the highest slider position will set a value of $+50$.

```
TVF:Atouch sens
#00 +20 -40 +30
```

【Values】 [-50—+50]

For positive (+) values, increased aftertouch will raise the cutoff frequency. For negative (-) values, increased aftertouch will lower the cutoff frequency. For a value of 0, aftertouch will not affect the cutoff frequency.

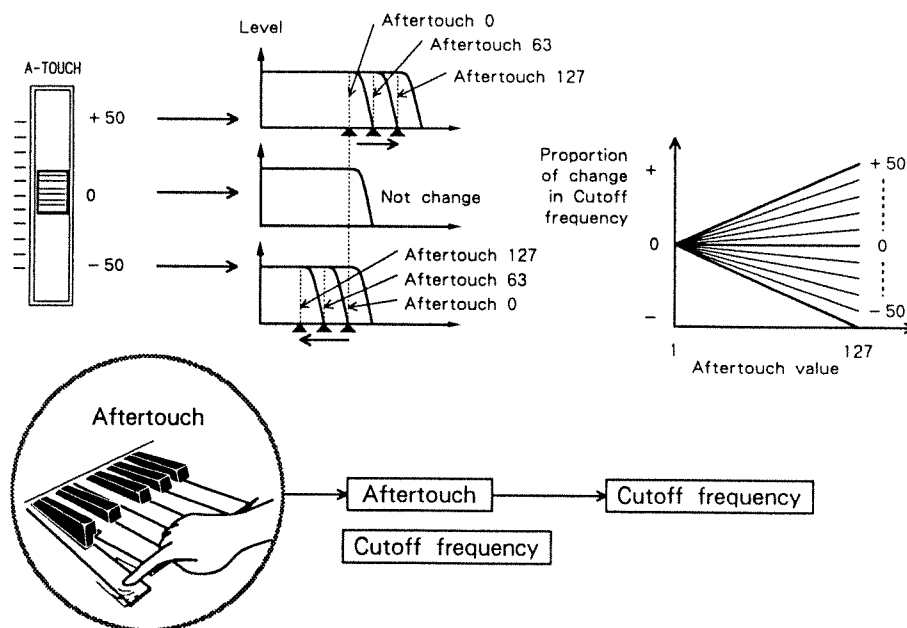

* If the cutoff frequency (☞ P. I - 52) has been set to 100, or if TVF envelope levels (☞ P. I - 64) have all been set to 100, positive (+) settings of Aftertouch Cutoff Sensitivity will have no effect.

● TVF envelope

The parameters in this block determine how the cutoff frequency will change over time.

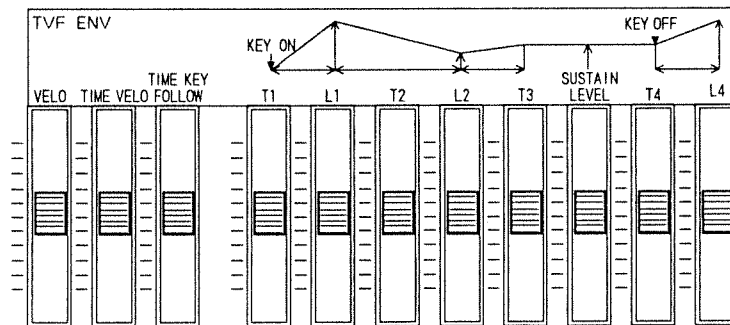
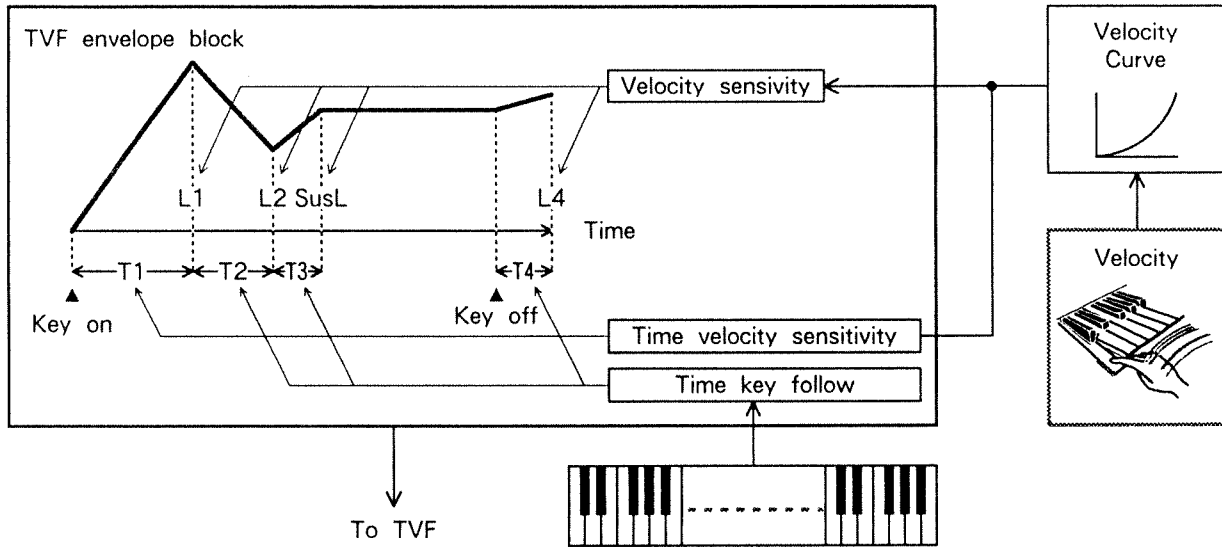

○ Velocity sensitivity

This parameter determines how the levels L0, L1, L2, and L4 of the TVF envelope will be affected by velocity. This allows the TVF envelope to change in response to velocity, affecting the tone color. This can be used to simulate the differences in tone color that occur between loud and soft notes on acoustic instruments.

① Move **VELO**.

```
F-ENV:Velo
+00 +50 -50 00
```

【Values】 [- 50 — + 50]

For positive (+) values, stronger velocities will increase the levels of the TVF envelope. For negative (–) values, stronger velocities will decrease the levels of the TVF envelope. For a value of 0, velocity will have no effect on TVF envelope levels.

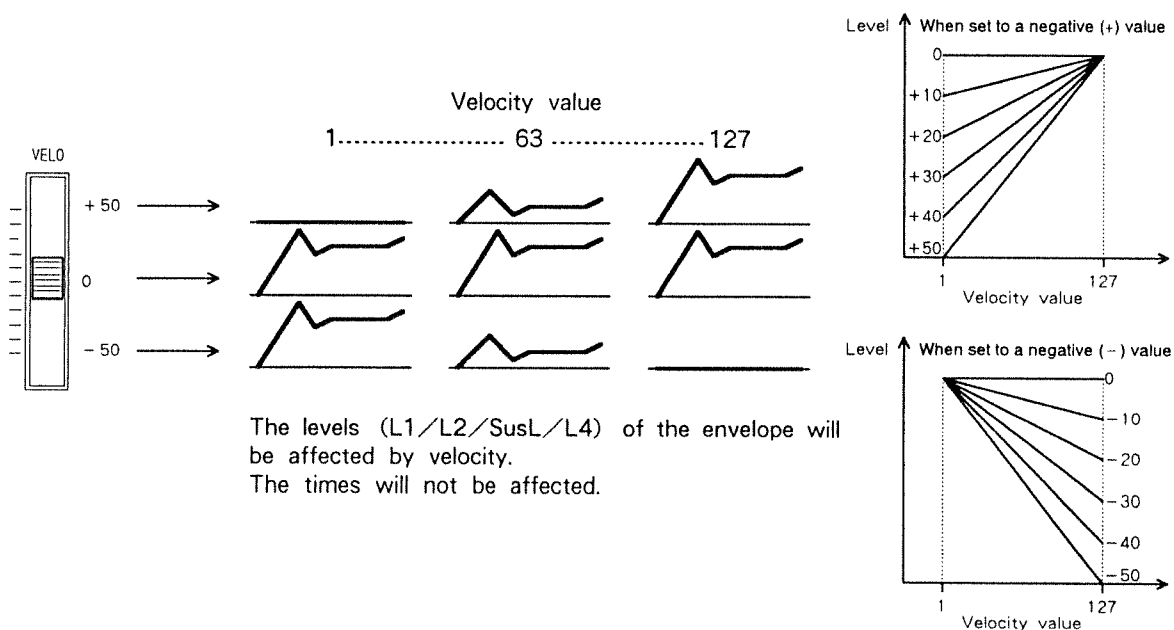

The levels (L1/L2/SusL/L4) of the envelope will be affected by velocity.
The times will not be affected.

- * The velocity of the note you play will be processed through the Velocity Curve (P. I – 17) before being applied to this parameter.
- * The resulting levels will not exceed the levels you specify in L1/L2/Sustain level/L4.

Sound idea

For example, by setting a value of +50, strongly played notes will be brighter, and softly played notes will be darker.

○ Time velocity sensitivity

This parameter determines how the T1 of the TVF envelope will be affected by velocity. This allows the TVF envelope to change in response to velocity, affecting the tone color.

① Move **TIME VELO**.

```
F-ENV:Time velo
+00 +50 -50 00
```

【Values】 [- 50 — + 50]

For positive (+) values, stronger velocities will shorten the time (T1) of the TVF envelope. For negative (-) values, stronger velocities will lengthen the time (T1) of the TVF envelope. For a value of 0, velocity will have no effect on TVF envelope times.

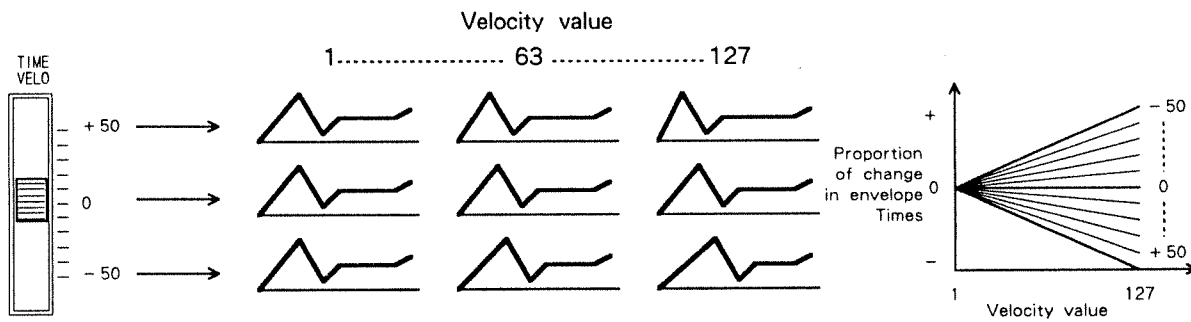

The times (T1) of the envelope will be affected by velocity.
The levels will not be affected.

* The velocity of the note you play will be processed through the Velocity Curve (P. I - 17) before being applied to this parameter.

Sound idea

For example, by setting a value of +50, the tone color of softly played notes will change slowly, and the tone color of strongly played notes will change rapidly. This can be useful for sound effects.

○ Time key follow

This parameter specifies how keyboard position will affect the TVF envelope times except T1. Different keyboard areas will result in different TVF envelope shapes, creating different sounds.

① Move **TIME KEY FOLLOW**.

```
F-ENU:Time KF
 00 +10 -10 00
```

[Values] [- 10 — + 10]

For positive (+) values, the times (T2, T3, T4) of the TVF envelope will become shorter as you play higher notes (i.e., towards the right). For negative (–) values, the times (T2, T3, T4) of the TVF envelope will become longer as you play higher notes. For a value of 0, the times of the TVF envelope will not be affected by keyboard position.

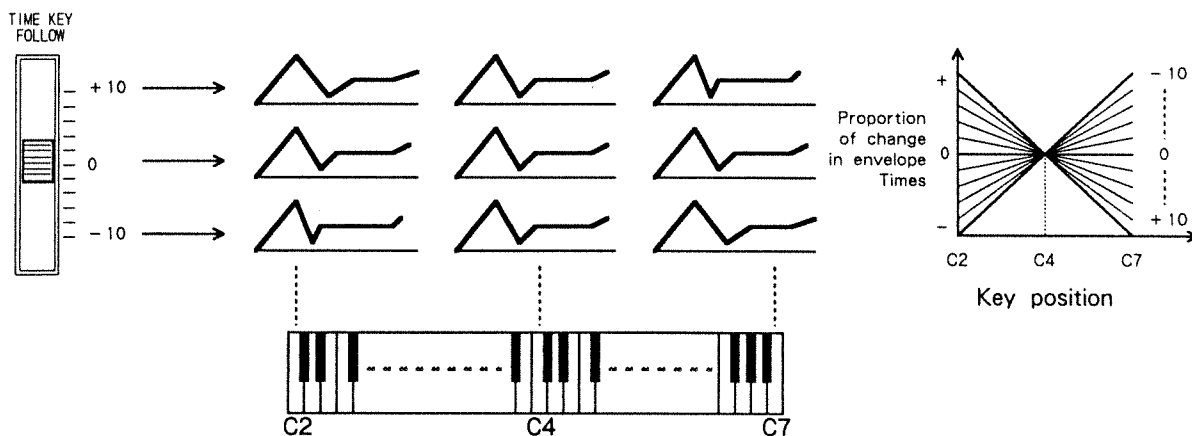

The times (T2/T3/T4) of the envelope will be affected by keyboard position.
The levels will not be affected.

*** C4 is the center key around which the Key Follow effect occurs; i.e., as you play above (or below) the C4 key, the values you set for the TVF envelope will be adjusted.**

Sound idea

For example, the change in tone color over time occurs more rapidly for higher notes on a piano. This can be simulated by setting Time Key Follow to a positive (+) value, so that higher notes will change in tone color more rapidly.

○ Level L1 / L2 / sustain level / L4

These parameters set the levels of the TVF envelope; Level 1/2/sustain level/4. After being adjusted by the TVF Envelope Depth value (⇨ P. I - 55), these levels will make the cutoff frequency change over time.

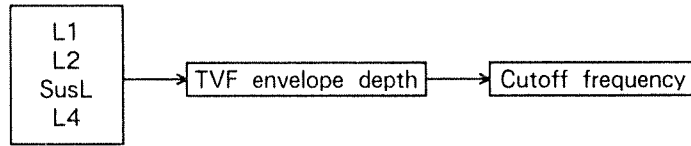

① Move **L1 / L2 / SUSTAIN LEVEL / L4**.

| | | | | |
|-----------------|------|----|----|----|
| F-ENV:Level 1 | ↑100 | 90 | 30 | 80 |
| F-ENV:Level 2 | ↑100 | 90 | 30 | 80 |
| F-ENV:Sus level | ↑100 | 90 | 30 | 80 |
| F-ENV:Level 4 | ↑100 | 90 | 30 | 80 |

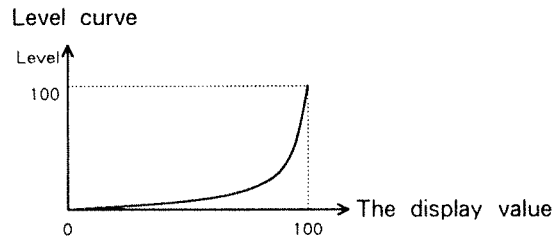

【Values】 [0—100]

Higher values will result in greater change in cutoff frequency. For a value of 0, the cutoff frequency you set with **CUTOFF FREQ** will be used.

* If the Velocity Sensitivity is other than 0, the values you specify here will be affected by velocity.

* Level 4 is the level after the key is released (Key Off). If the TVA envelope T4 (⇨ P. I - 80) is short, it will be difficult to hear the result of this parameter.

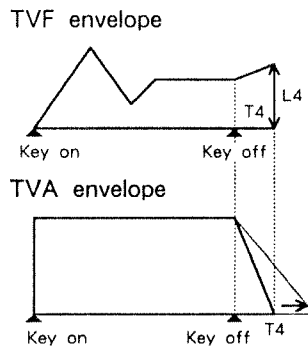

This effect will be difficult to notice unless the TVA envelope T4 is set longer than the TVF envelope T4.

○ Time 1/2/3/4

These parameters set the times of the TVF envelope; Time 1/2/3/4. They specify the time over which the cutoff frequency will change from one level of the envelope to the next (for example, from L1 to L2).

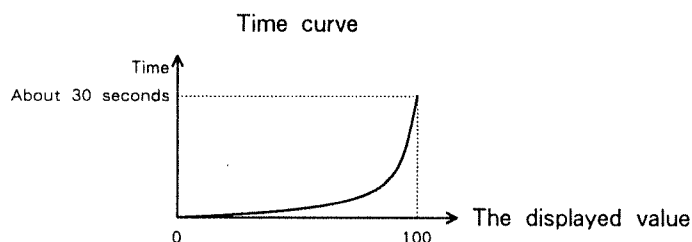

① Move **T1 / T2 / T3 / T4**.

```
F-ENU:Time 1
▶10 10 30 50
```

```
F-ENU:Time 2
▶10 10 30 50
```

```
F-ENU:Time 3
▶10 10 30 50
```

```
F-ENU:Time 4
▶10 10 30 50
```

【Values】 [0—100]

Higher values will result in a longer time before the next level is reached.

*If the Time Velocity Sensitivity is other than 0, the time of T1 will be affected by velocity.

*If the Time Key Follow is other than 0, the times of T2/T3/T4 will be affected by keyboard position.

● TVA

TVA stands for Time Variant Amplifier; i.e., an amplifier that changes the volume over time. This block contains volume-related parameters.

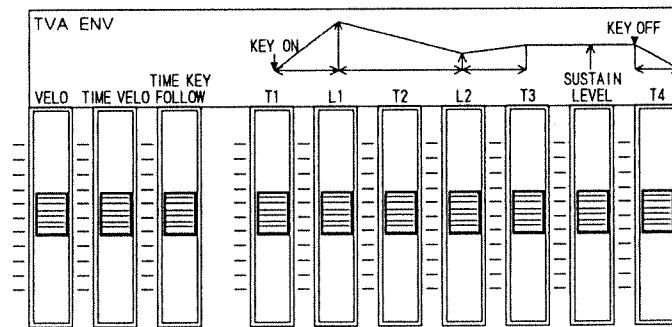
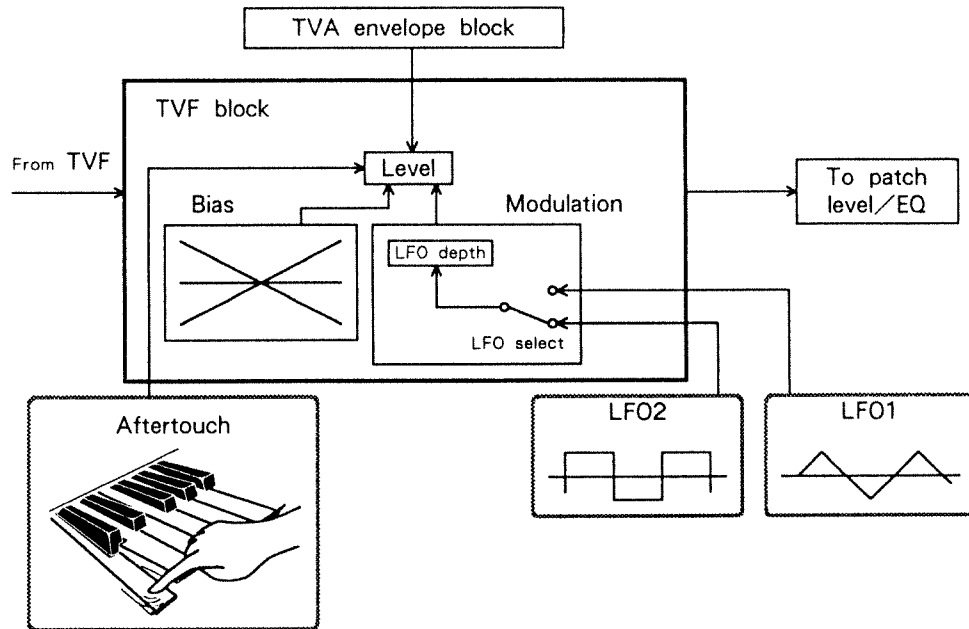

○ Level

This parameter specifies the volume of the Tone. Use this parameter to adjust the volume balance between Tones.

① Move **LEVEL**.

```
TVA:Level
├100  90  80  70
```

【Values】 [0—100]

Higher values will result in a higher volume. It depends on TVA envelope setting.

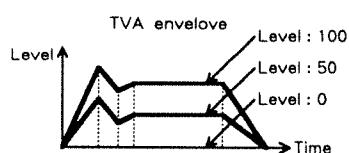

* The final volume is specified by the Patch Level (☞ P. I – 119).

* When a Patch is selected, this parameter will always be displayed.

* If the TVA envelope L1/L2/SUSTAIN LEVEL parameters are all 0, there will be no sound, regardless of this parameter setting.

Note

When this parameter is shown in the display, you can use the Palette (☞ P. I – 9) to adjust the volumes of the four Tones, just as though you were using a mixer. When you select another Patch, this parameter will be shown in the display.

2. TONE EDIT

Tone edit / TVA / Bias direction

○ Bias direction

When you want the volume to be affected by keyboard position, this parameter specifies the direction in which change will occur; i.e., whether the volume will be adjusted above or below a certain key.

Notes played on an acoustic instrument will have different volumes depending on their pitch range, and this is perceived to be more natural. To simulate this, the JD-800 provides Bias parameters. This Bias Direction parameter specifies the direction of the biasing.

① Press **BIAS DIRECTION**.

The indicator of the selected value will light.

```
TVA: Bias dir
  UP LOW U&L  UP
```

[Values] [UP, LOW, U & L]

UP : The volume will be adjusted above the specified key.

LOW : The volume will be adjusted below the specified key.

U & L : The volume will be adjusted above and below the specified key.

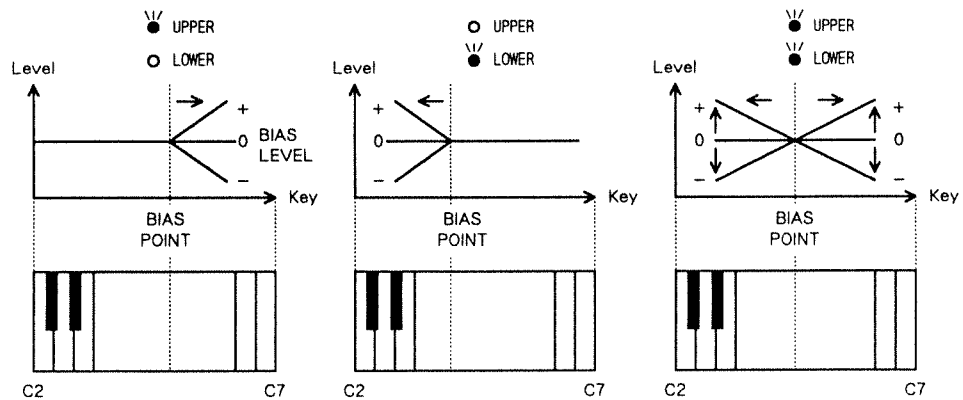

* The key is specified by the Bias Point (P. I - 70).

Sound idea

◇By using two Tones set respectively to UP and to LOW, you can make them overlap in a keyboard area (“key crossfade”).

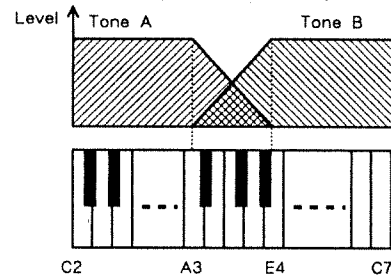

| Bias | | | |
|--------|-----------|-------|-------|
| | Direction | Point | Level |
| Tone A | UP | A3 | - 10 |
| Tone B | LOW | E4 | - 10 |

◇By selecting U&L, you can make the Tone sound only in a specified keyboard area.

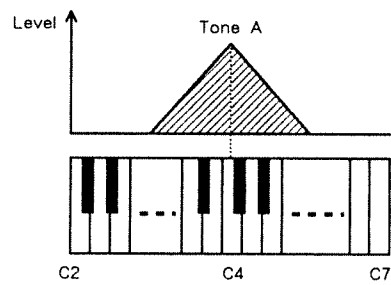

| Bias | | | |
|--------|-----------|-------|-------|
| | Direction | Point | Level |
| Tone A | U & L | C4 | - 10 |

2. TONE EDIT

Tone edit / TVA / Bias point

○ **Bias point** When you want the volume to be affected by keyboard position, this parameter specifies the note from which change will occur.

By using Transpose, you can extend the notes played by the JD-800's keyboard over the range of C1 to C8. However, this Bias Point parameter is set as one of the 128 notes from C - 1 to G9 (the note numbers used when note messages are received from MIDI IN).

① Move **BIAS POINT**.

The lowest value is C - 1, and the highest value is G9.

```
TVA: Bias point
  *C4  C2  F#4  C7
```

[Values] [C - 1 - G9]

Set the key you want the volume to change from.

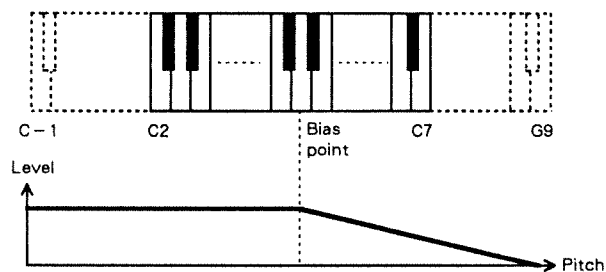

Sound idea

By using this together with the Patch Common parameter Key Range (⇐ P. I - 120), you can create even more complex Tones.

○ **Bias level** When you want the volume to be affected by keyboard position, this parameter specifies the amount of change.

This determines how greatly the volume will change from the Bias Point in the Bias Direction.

① Move **BIAS LEVEL**.

```
TVA: Bias level
+10 +02 -05 00
```

【Values】 [- 10—0— + 10]

For positive (+) values, higher notes will have a louder volume. For negative (-) settings, higher notes will have a lower volume. For a setting of 0, the volume will not change.

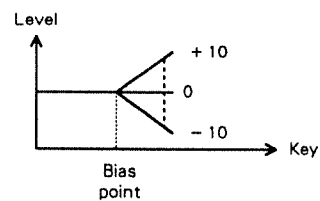

* Even for a positive (+) value, the resulting level will never exceed the maximum level (100).

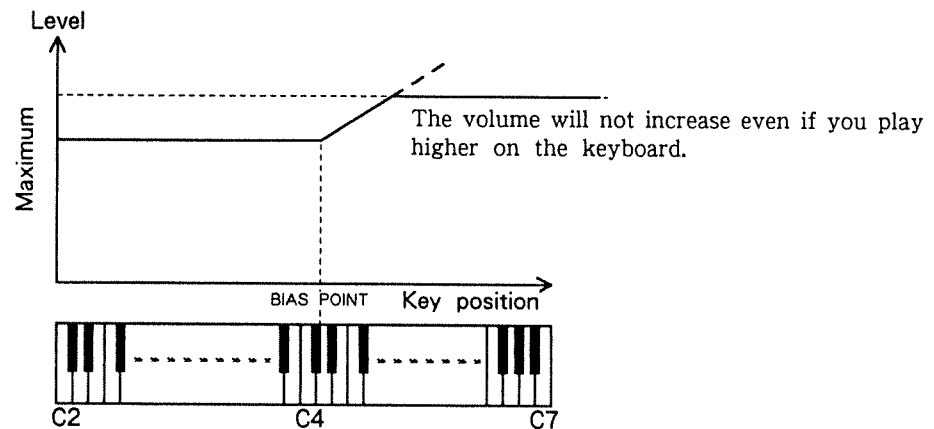

○ Aftertouch level sensitivity

This parameter specifies how volume will be affected by aftertouch (pressure on the keyboard after playing a key). This allows you to increase or decrease the volume as you play.

① Move **A-TOUCH**.

```
TVA:Atouch sens
+20 -30 00 +05
```

【Values】 [- 50— + 50]

For positive (+) values, aftertouch will increase the volume. For negative (-) values, aftertouch will decrease the volume. For a value of 0, aftertouch will not affect the volume.

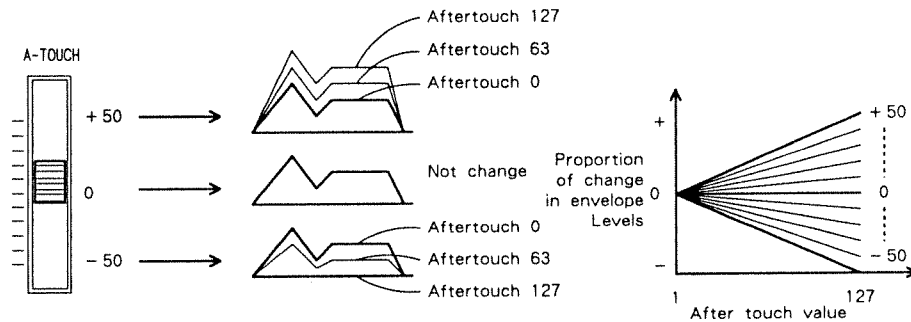

* By setting a value such as +50, you can apply aftertouch to gradually increase the volume.

* Even for a positive (+) value, the resulting level will never exceed the maximum level (100).

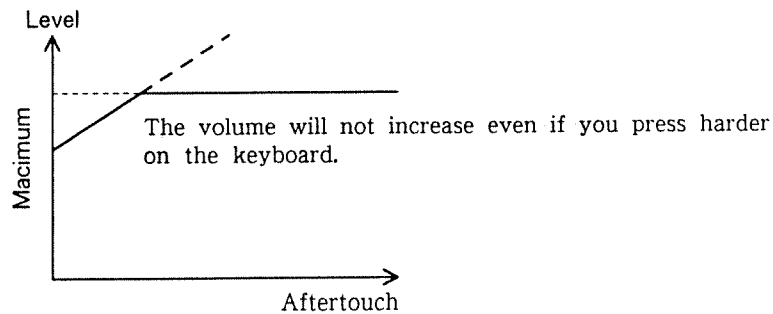

○ LFO modulation select

This parameter selects the LFO that will modulate the level. By using an LFO to modulate the level, you can create a tremolo effect.

① Press **LFO SELECT**.

The indicator of the selected LFO will light.

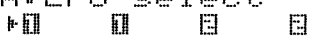
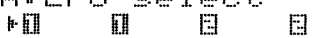
TVA:LFO select  indicates LFO1, and  indicates LFO2.

【Values】 [**1**, **2**]

1 : LFO 1 will affect the volume.

2 : LFO 2 will affect the volume.

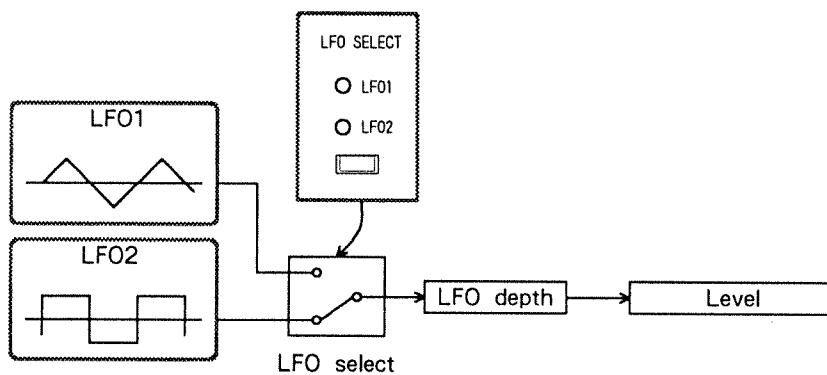

*The following parameter (LFO Modulation Depth) specifies how greatly the LFO will affect the volume.

○ LFO modulation depth

This parameter specifies how greatly the LFO will affect the volume (i.e., the tremolo depth). Specify depth and phase to create a tremolo effect.

① Move **LFO**.

```
TVA:LFO depth
+50 -50 00 00
```

【Values】 [- 50 — + 50]

For positive (+) values, the LFO will be applied in positive polarity. For negative (-) values, the LFO will be applied in negative polarity. For a value of 0, there will be no modulation.

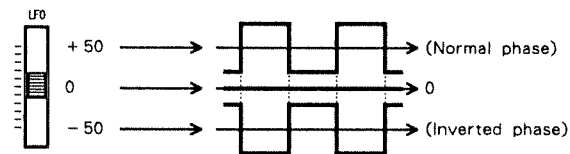

* If you want to create only a tremolo effect, set the other LFO depth parameters (pitch, cutoff) to 0.

* Regardless of the LFO offset setting (P. I - 25), an offset setting of “0” will be modulated.

● TVA envelope

This block contains parameters to specify change in volume over time.

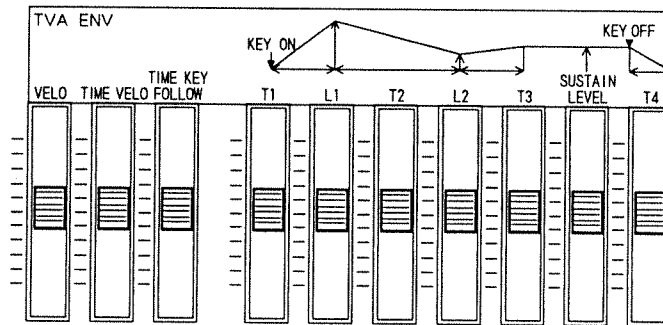
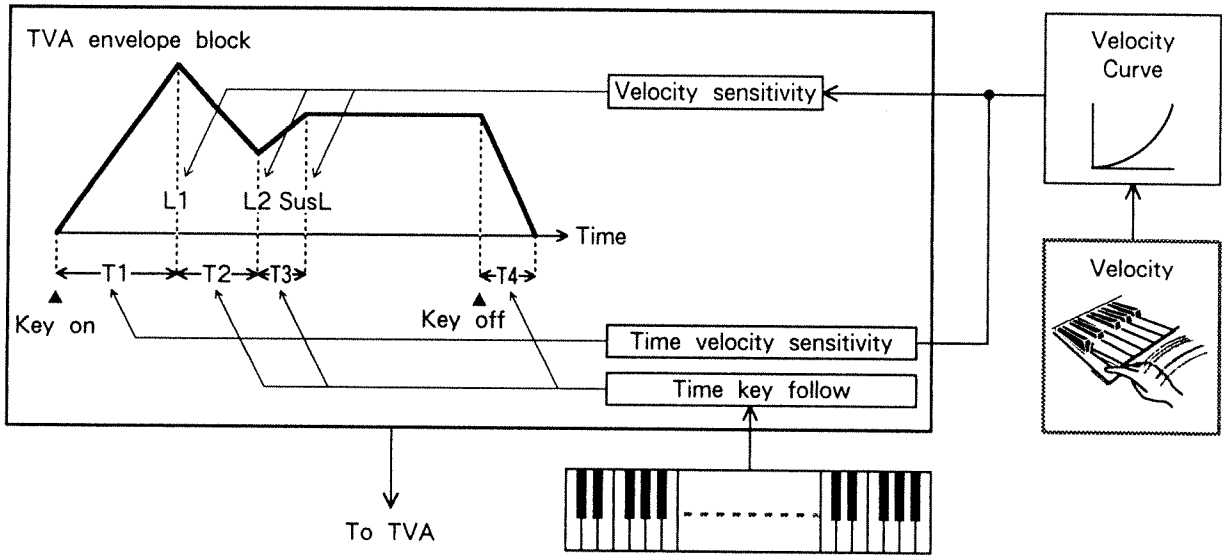

2. TONE EDIT

Tone edit/TVA envelope/Velocity sensitivity

○ Velocity sensitivity

This parameter determines how the times L1, L2, and SUSTAIN LEVEL of the TVA envelope will be affected by velocity. This will affect the shape of the TVA envelope, and affect the way in which the volume changes over time. This allows you to make strongly played and softly played notes differ in volume, for more dynamic performances.

① Move **VELO**.

```
A-ENU:Velo
+00 +50 -50 00
```

【Values】 [- 50 — + 50]

For positive (+) values, the levels of the TVA envelope will increase as the velocity increases. For negative (-) values, the levels of the TVA envelope will decrease as the velocity increases. For a value of 0, the levels of the TVA envelope will not be affected by velocity.

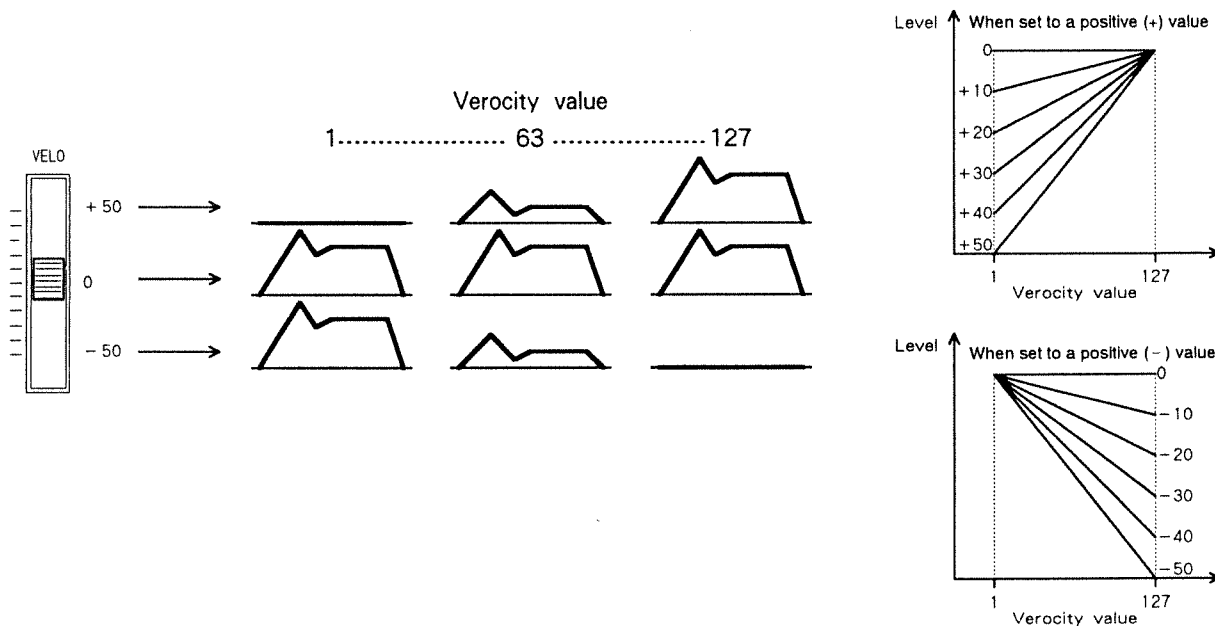

* The velocity of the note you play will be processed through the Velocity Curve (P. I - 17) before it is applied to this parameter.

* The resulting level will not exceed the levels you specified in L1/L2/SUSTAIN LEVEL.

Sound idea

For positive (+) values, strongly played notes will be loud, and softly played notes will be soft. As you increase the value of this parameter, the changes in volume will become more pronounced.

○ Time velocity sensitivity

This parameter determines how the time T1 of the TVA envelope will be affected by velocity. This allows the TVA envelope to change in response to velocity, affecting the volume change over time.

① Move **TIME VELO**.

```
A-ENV:Time velo
+00 +50 -50 00
```

[Values] [- 50 — + 50]

For positive (+) values, the TVA envelope time (T1) will shorten as the velocity increases. For negative (–) values, the TVA envelope time (T1) will lengthen as the velocity increases. For a value of 0, the times of the TVA envelope will not be affected by velocity.

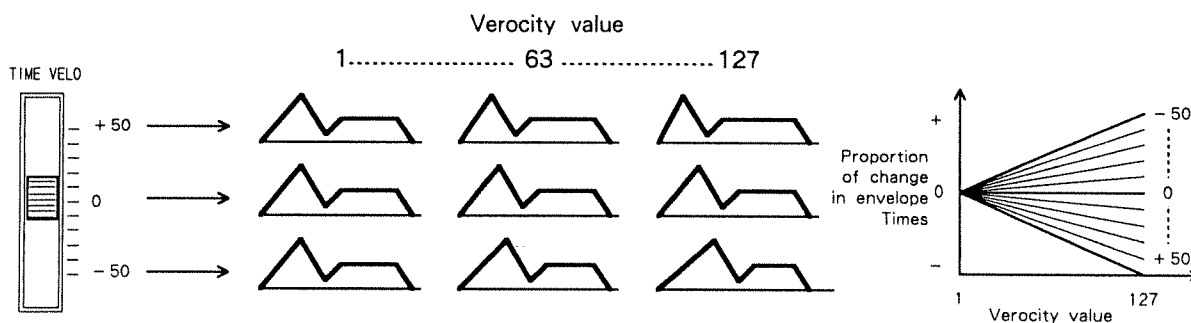

The time (T1) of the envelope will be affected by velocity.
The levels will not be affected.

*The velocity of the note you play will be processed through the Velocity Curve (P. I – 17) before it is applied to this parameter.

Sound idea

A value of about +30 is especially appropriate for strong sounds. Softly played notes will change slowly in volume, and strongly played notes will change quickly.

2. TONE EDIT

Tone edit/TVA envelope/Time key follow

○ Time key follow

This parameter specifies how the TVA envelope times (T2, T3, T4) will be affected by keyboard position. This will make the TVA envelope (and therefore the volume change) have a different shape for different areas of the keyboard.

① Move **TIME KEY FOLLOW**.

```
A-ENV:Time KF
+00 +10 -10 00
```

【Values】 [- 10 — + 10]

For positive (+) values, the TVA envelope times (T2, T3, T4) will shorten with higher notes (toward the right of the keyboard). For negative (-) values, the TVA envelope times (T2, T3, T4) will lengthen as you play higher notes. For a value of 0, the times of the TVA envelope will not be affected by keyboard position.

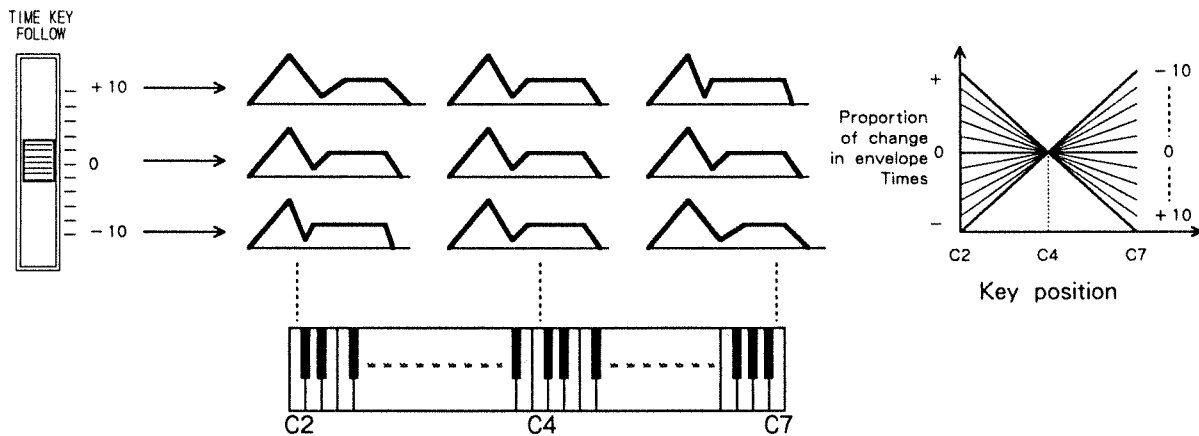

The times (T2/T3/T4) of the envelope will be affected by keyboard position.
The levels will not be affected.

* C4 is the center key around which the Key Follow effect occurs; i.e., as you play above (or below) the C4 key, the values you set for the TVA envelope will be effective.

Sound idea

On instruments like pianos, higher notes will also have a faster change in volume. You can simulate this with positive (+) values of the Time Key Follow parameter, so that higher notes will have an increasingly faster decay.

○ Level 1/2/sustain level

These parameters specify the levels (1, 2, sustain level) of the TVA envelope, to specify the points to which the volume will change over time.

① Move **L1 / L2 / SUSTAIN LEVEL**.

The lowest slider position represents a value of 0, and the highest a value of 100.

| | | | | |
|------------------|------|----|----|----|
| A-ENV: Level 1 | ▶100 | 90 | 30 | 80 |
| A-ENV: Level 2 | ▶100 | 90 | 30 | 80 |
| A-ENV: Sus level | ▶100 | 90 | 30 | 80 |

[Values] [0—100]

Higher values will result in a louder volume.

Level curve

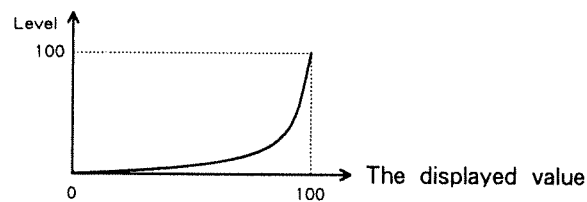

* If the Velocity Sensitivity is other than 0, these values will be affected by velocity.

* If all these levels are set to 0, there will be no sound.

Sound idea

For example, by setting L1 to 0 and setting T1 to an appropriate value, you can create envelopes in which the sound begins a short time after you play the note.

The effect of the Delay Start envelope

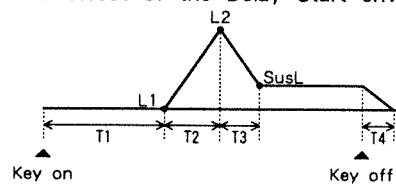

2. TONE EDIT

Tone edit/TVA envelope/Time 1/2/3/4

○ Time 1/2/3/4

These parameters specify the TVA envelope times (T1, T2, T3, T4). They specify the time over which the volume will change from one level to the next (for example, from L1 to L2).

① Move T1 / T2 / T3 / T4.

```
A-ENV:Time 1
*10 10 30 50
```

```
A-ENV:Time 2
*10 10 30 50
```

```
A-ENV:Time 3
*10 10 30 50
```

```
A-ENV:Time 4
*10 10 30 50
```

【Values】 [0—100]

Higher values will result in longer times to reach the next level.

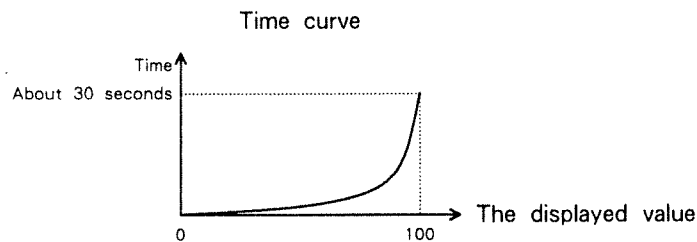

* If the Time Velocity Sensitivity is other than 0, the time of T1 will be affected by velocity.

* If the Time Key Follow is other than 0, the times of T2/T3/T4 will be affected by keyboard position.

* Even if you have set Pitch Envelope / TVF Envelope / LFO parameters to create change after the key is released, the effect will not be heard if T4 is set to a short (low) value.

* If T4 is set near or at 100, it will take a long time for the sound to disappear completely.

When T4 is set to 100

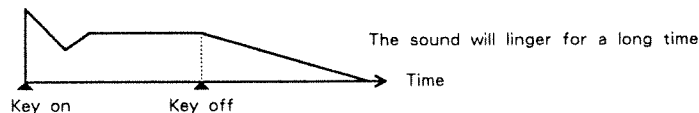

3. PATCH EDIT

We will set various parameters related to the Patch.

● How a Patch is organized

The following diagram shows the groups into which the parameters of a Patch are organized; a Common group, Effects group, and Tones A—D. In the Common parameter group, you can set performance functions and equalizer settings. In the Effects parameter group, you can make settings for the effects unit.

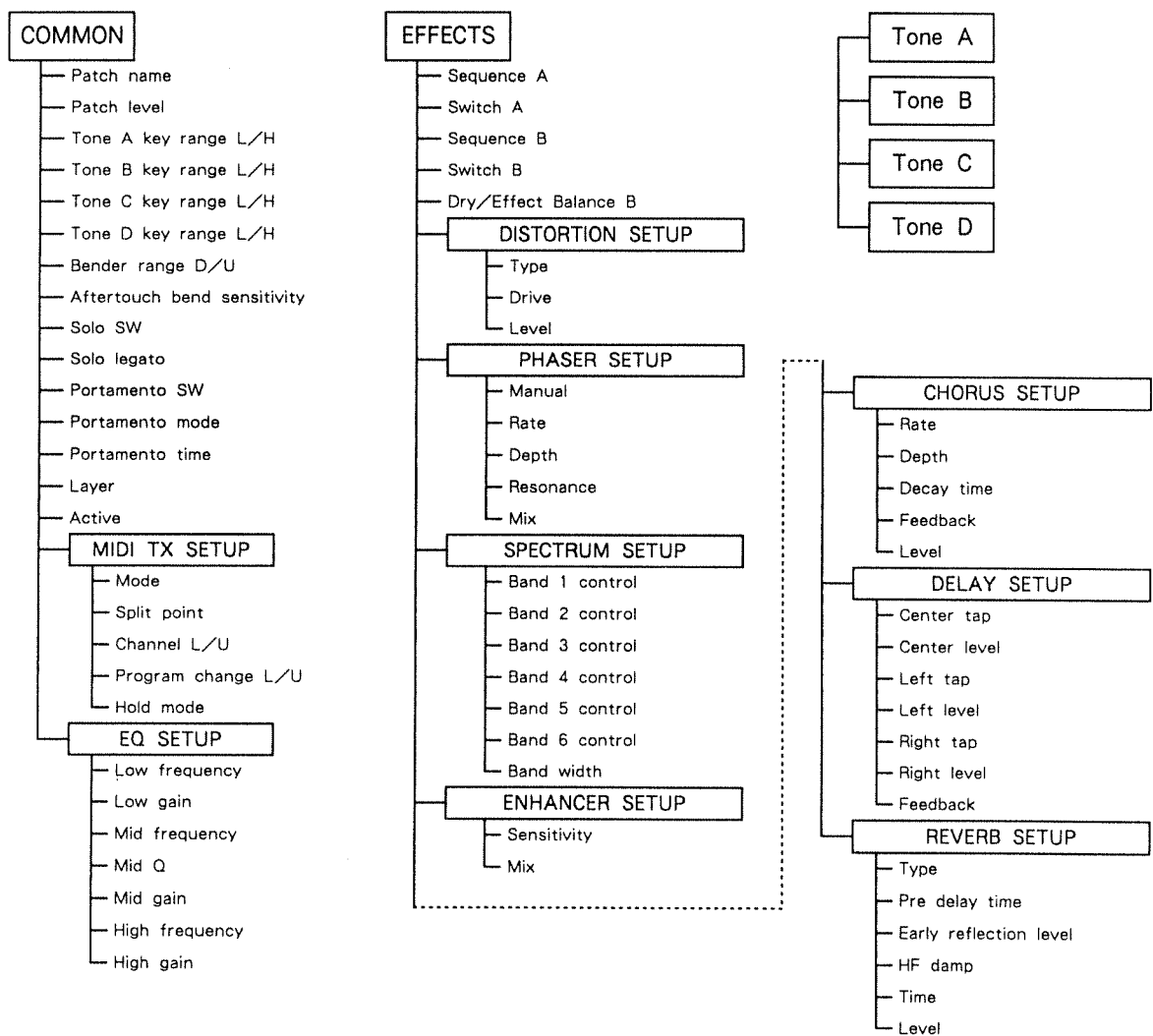

* You can edit Tones even while editing a Patch.

* Since the same Patches are used in both Single mode and Multi mode, you can edit Patches regardless of the play mode.

* During Patch editing, program change messages will not be received.

● Functions during Patch editing

The JD-800 provides several convenient functions for use during Patch editing.

○ Patch write/compare

The operation of storing edited parameters into a Patch is called Patch Write. During the Patch Write operation, you can listen to the sound of the original Patch using the Patch Compare operation.

This allows you to check the data in the writing destination before you overwrite it with your edited settings.

*** Each Patch contains all the previously given listed parameters; Common, Effect, and Tone A — D.**

《Writing procedure》

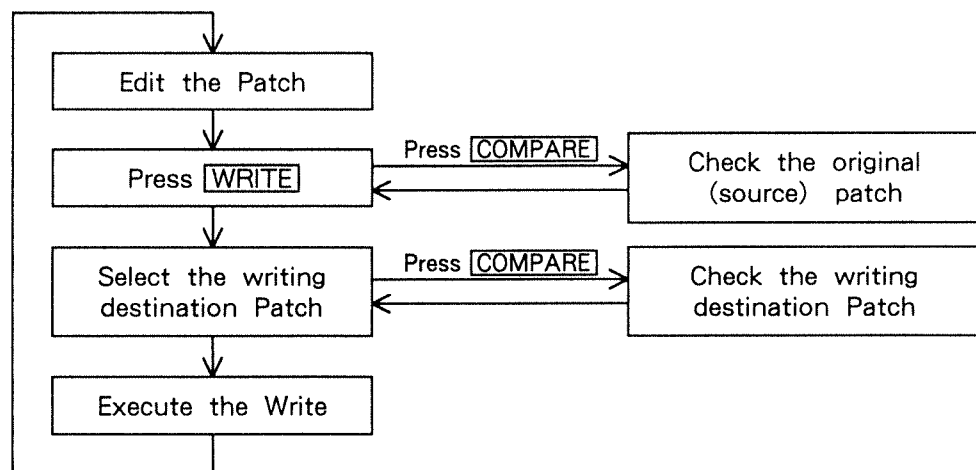

- ◇ Patch write This operation writes the Patch parameters (including the Tone parameters) into memory. Your editing affects only the data in the temporary area.

When you select another patch, the Patch data that you have edited, is copied into the temporary area, overwriting the previous data.

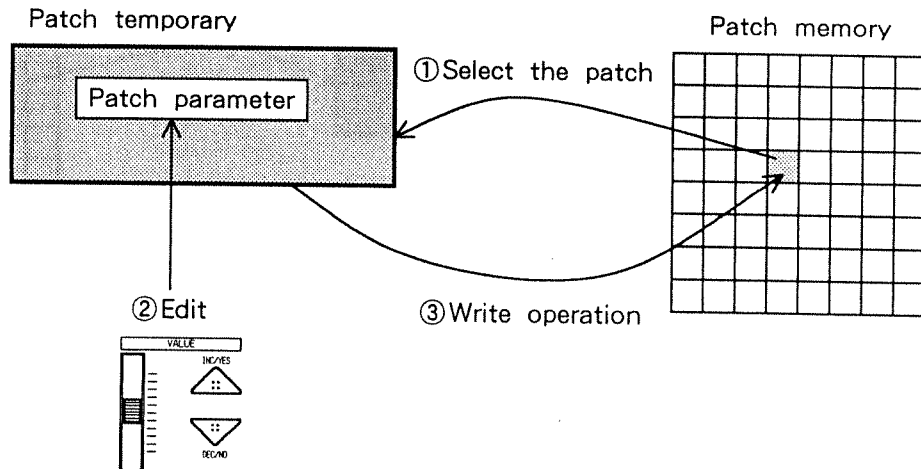

The data in the temporary area will be lost when you select another Patch or when you turn the power off. If you wish to keep your edited data, you must use the Write operation to save the edited data into internal (INT) or card (CRD) memory.

- ① Press **WRITE**.

The Patch number will blink.

```
WRITE from TMP
to I-11 ?      [Y/N]
```

- ② Press **INT / CARD**, BANK **1**–**8**, NUMBER **1**–**8** to select the writing destination Patch.

- ③ Press **INC / YES** and the data will be written into memory.

```
WRITE from TMP
to I-11 ?      Completed
```

To cancel without writing, press **DEC / NO**.

```
WRITE from TMP
to I-11 ?      Canceled
```

- ④ You will return to the previous display.

3. PATCH EDIT

Patch compare

◇ Patch compare

During step ② of the Patch Write operation, you can compare the sound of the edited Patch with the original Patch.

This function allows you to avoid overwriting an important Patch with your edited settings.

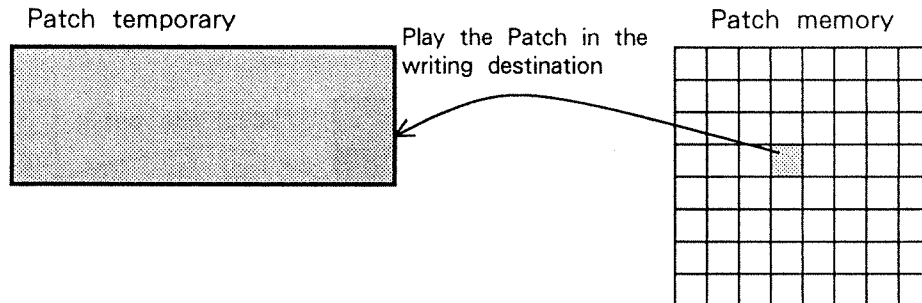

You can then select an unneeded Patch, and store your edited data there. This function also can be used to compare the edited and unedited sounds.

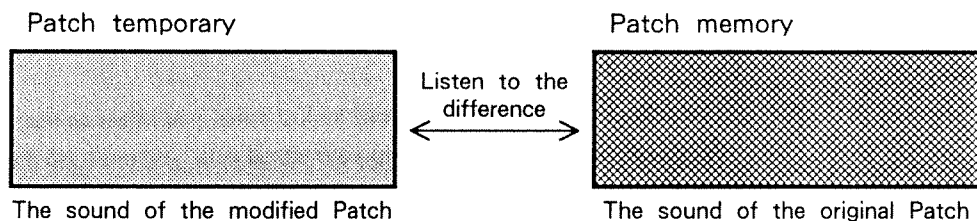

- ① From step ② of the Write procedure, press **COMPARE**.

```
COMPARE
TMP with 1-11
```

- ② Press **INT/CARD**, BANK **1-8**, NUMBER **1-8** to select the Patch you wish to hear.
- ③ When you have decided on a writing destination, press **COMPARE** once again. You will return to step ② of the Write procedure.

Application ideas By using the Patch Write and Patch Compare functions, you can move Patches between a DATA card and internal memory. For example, you can move an internal Patch into a DATA card by using the following procedure.

- ① Select the internal Patch you wish to rearrange.
- ② Insert a DATA card into the card slot, and set the protect switch to "OFF".
- ③ Press **WRITE**.
- ④ Press **COMPARE**.
- ⑤ Use **INT/CARD**, BANK **1**—**8**, and NUMBER **1**—**8** to select the other Patch into which you want to place the previously-selected Patch.
- ⑥ After selecting the Patch, press **COMPARE** once again.
- ⑦ Press **INC/YES** and the Patch will be written into the DATA card.
- ⑧ Repeat steps ①—⑦ as necessary.

3. PATCH EDIT

Patch copy

○ Patch copy It is sometimes convenient to use the Copy function when editing. This function writes data from a selected copy source Patch into the Temporary area. Here, we will explain how to copy Patch Common or Effect parameters.

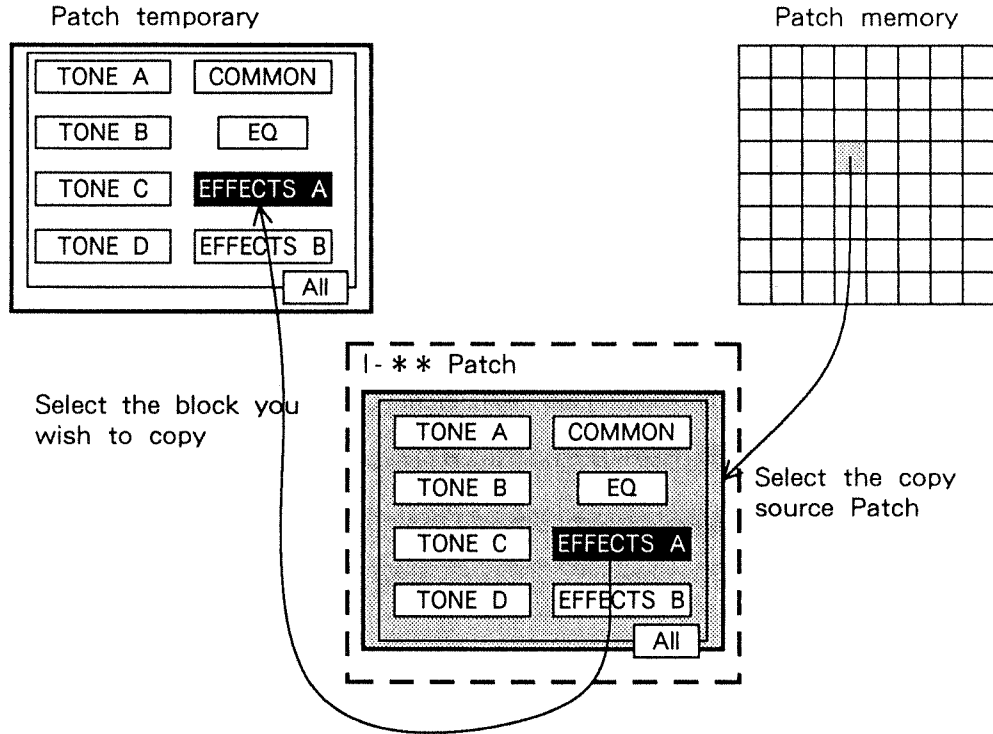

For example, this operation will be convenient when you want to copy just the effect settings from a certain Patch into the Patch you are now editing.

*** You can also copy between Tones in the Patch Temporary area.**

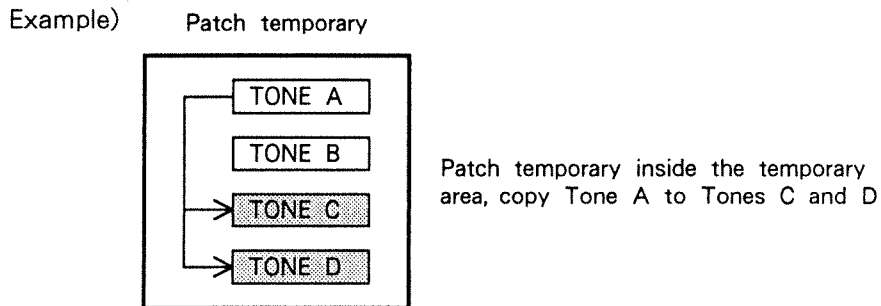

For details, refer to "Tone Copy", (P. I - 10).

- ① While editing a Patch, press **COPY**.

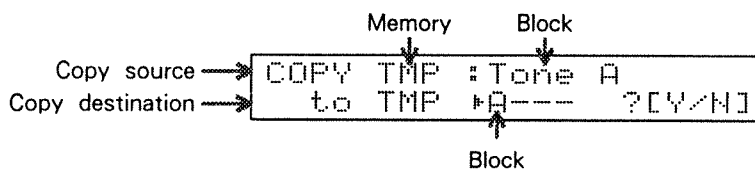

The upper line shows the copy source memory and block. The lower line shows the copy destination block.

- ② Select the copy source Patch using **INT/CARD**, BANK **1**—**8**, and NUMBER **1**—**8**.

```

COPY I-11:Tone A
to TMP *A--- ?[Y/N]
  
```

- ③ Press PAGE **▲** **▼** to select the copy source block.

In this example, select either Eff A, Eff B, Common or EQ.

```

COPY I-11:Eff A
to TMP *Eff A ?[Y/N]
  
```

The block display in the lower line will change in accordance with the block selected in the upper line.

The display in this example is asking “Shall I copy the Effect group A settings from Patch I-11 into the temporary area?”.

- ④ To execute the copy operation, press **INC/YES**.

```

COPY I-11:Eff A
Completed
  
```

To cancel without copying, press **DEC/NO**.

```

COPY I-11:Eff A
Canceled
  
```

- ⑤ You will return to the previous display.

* In steps ② or ③, it is a good idea to listen to the sound of the copy source block (for example, the Effect block) before you copy the data.

* If you wish to save the data you copied, remember to use the Patch Write operation (P. I - 83).

* If you select “All” as the block and execute the copy operation, all the Patch parameters will be copied into the temporary area. This will have the same result as selecting that Patch.

1) Patch Effects settings

Here you can make effects settings. They allow you to add various effects to the sound you created by layering Tones.

● Patch Effects

There are two effects groups; A and B.

Group A is mono in, mono out. Group B is mono in, stereo out.

The following diagram shows how the sound passes through the effects.

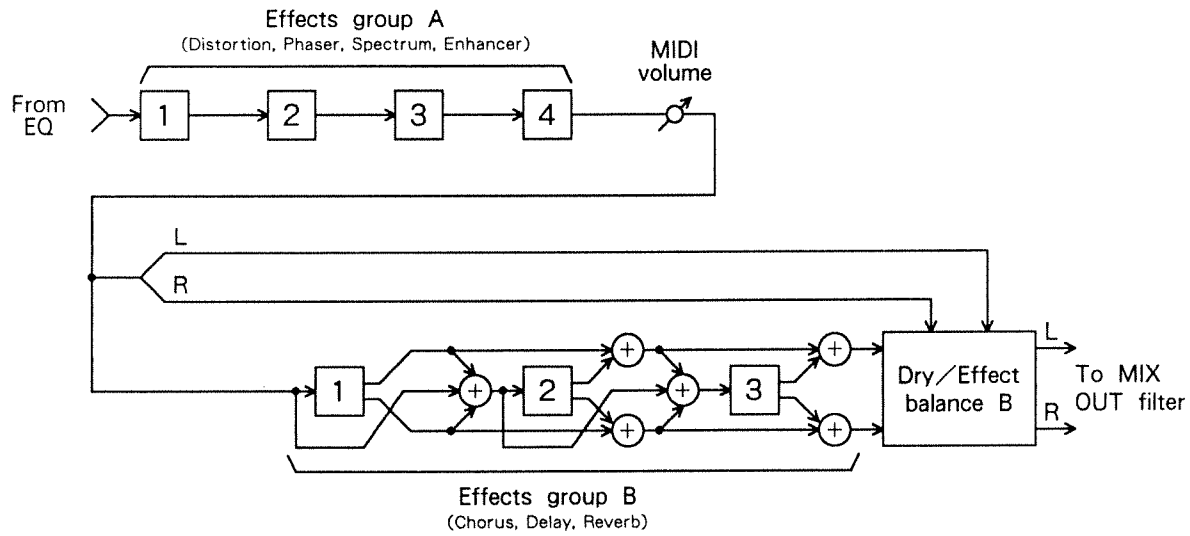

After specifying the order and on/off setting for the effects, set the parameters for each effect.

- ① Press **EFFECTS**.
- ② Press PAGE **▲▼** to select the parameter.
- ③ Make settings in each display page (effect on/off, and effect parameter settings).
- ④ Repeat steps ② and ③ as necessary.
- ⑤ Press **EXIT** to return to the previous play mode.

* It is not possible to reverse the order of effects groups A and B.

* *When you want to use the effects of effect group B, turn the Effect Master switch “on” (☞ P. III – 9).

* In both Single mode and Multi mode, the MIX OUT jacks will output the processed sound combined with the direct (unprocessed) sound.

* When you set Part Output Assign (☞ P. II – 11) to “DIR” in multi mode, only the original sound will be output from the DIRECT OUT jacks.

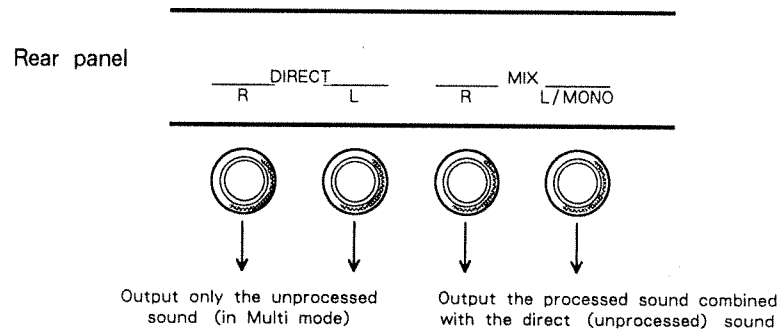

3. PATCH EDIT

Patch edit/Effects/Sequence A

○ **Sequence A** Here you can specify the order of the effects in group A.

```
PATCH EFF Sequence A
#-DS---PH---SP---EN-
```

Group A contains effects that process the original sound. The results will differ greatly depending on the order of the effects. Experiment!

Each effect performs the following function.

DS (distortion) : Distorts the original sound.



PH (phaser) : Adds an out-of-phase copy of the original sound, to create a “swooshing” effect.

SP (spectrum) : Increases or decreases specified frequency areas to modify the tone color.

EN (enhancer) : Makes the sound more sharply defined, and adds clarity.

From step ③ of the procedure on page I – 89, use the following procedure.

③ – 1

Use the CURSOR   keys to move the “#” mark to the location where you wish to insert the effect.



```
PATCH EFF Sequence A
-DS---PH-#-SP---EN-
```

③ – 2

Use **VALUE** or **INC/YES** and **DEC/NO** to select the effect you wish to insert.

```
PATCH EFF Sequence A
-DS---PH-DS-SP---EN-
```

③ – 3

After selecting the effect you wish to insert, press CURSOR  .

The order will be rearranged.

```
PATCH EFF Sequence A
-PH---DS-#-SP---EN-
```

③ – 4

Repeat the above procedure as necessary.



*** When you have changed the effect order, you can reset the on/off status of each effect by using switch A on the next display page.**

○ **Switch A** Here you can switch each effect in group A on/off, in the order you specified in Sequence A.

```
PATCH EFF Switch A
▶PH---DS---SP---EN-
```

From step ③ of the procedure on page I - 89, use the following procedure.

③— 1

Use CURSOR   to move the "▶" mark to the effect you wish to turn on/off.

The effect at the "▶" mark will blink.

```
PATCH EFF Switch A
-PH---DS--▶SP---EN-
```

③— 2

Use **VALUE** or **INC/YES** and **DEC/NO** to turn the effect on/off.

When on, the abbreviation for the effect name will be displayed. When off, "[]" will be displayed.

```
PATCH EFF Switch A
-PH---DS--▶[ ]---EN-
```

When turned off, that effect will be bypassed.

On :

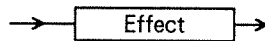

Off :

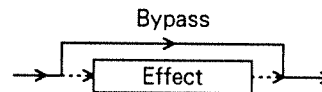

③— 3

Repeat the above procedure as necessary.

* Effect parameters can be adjusted only for effects which are on.

* If you turn on Distortion (DS), there will be no sound if the distortion level ( P.

I - 96) is set to 0.

○ **Sequence B** Here you can specify the order of the effects in group B.

```
PATCH EFF Sequence B
*--CH---DL---RV--
```

Group B contains effects that add delayed signals to the original sound. The results will differ depending on the order in which the effects are linked.

Each effect performs the following function.



CH (chorus) : Adds a slightly detuned sound, creating depth and spaciousness.

DL (delay) : Adds a delayed sound, creating echo effects.

RV (reverb) : Adds reflections and reverberation, creating acoustic ambience.



From step ③ of the procedure on page I – 89, use the following procedure.

③ – 1

Use the CURSOR   keys to move the "*" mark to the location where you wish to insert the effect.



```
PATCH EFF Sequence B
-CH-*--DL---RV--
```

③ – 2

Use **VALUE**  and  to select the effect you wish to insert.

```
PATCH EFF Sequence B
-CH-RV-DL---RV--
```

③ – 3

After selecting the effect you wish to insert, press CURSOR  .

The order will be rearranged.

```
PATCH EFF Sequence B
-CH-*--RV---DL--
```

③ – 4

Repeat the above procedure as necessary.



* When you have changed the effect order, you can reset the on/off status of each effect by using switch B on the next display page.

○ **Switch B** Here you can switch each effect of group B on/off, in the order you specified in Sequence B.

```
PATCH EFF Switch B
  ▶CH---RV---DL-
```

From step ③ of the procedure on page I - 89, use the following procedure.

③— 1

Use CURSOR   to move the "▶" mark to the effect you wish to turn on/off.

```
PATCH EFF Switch B
  -CH---RV---▶DL-
```

③— 2

Use **VALUE** or **INC/YES** and **DEC/NO** to turn the effect on/off.

When on, the abbreviation name of the effect will be displayed. When off, "[]" will be displayed.

```
PATCH EFF Switch B
  -CH---RV---▶[ ]-
```

When turned off, that effect will be bypassed.

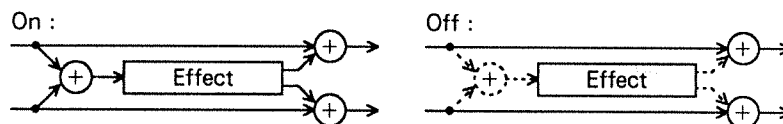

③— 3

Repeat the above procedure as necessary.

* Effect parameters can be adjusted only for effects which are on.

* Even if one or more effects are turned on here, the effects in group B will not be heard if Effect Balance B (next page) is set to DRY:100, EFF:00.

* If the following levels of each effect (CH/DL/RV) are set to 0, you may hear no sound.

◇ Chorus level (☞ P. I - 106)

◇ Delay { • Center level (☞ P. I - 108)
• Left level (☞ P. I - 109)
• Right level (☞ P. I - 109)

◇ Reverb { • Early reflection level (☞ P. I - 115)
• Level (☞ P. I - 116)

* The effect which is set to "off" by the Effect Master switch (☞ P. III - 9), cannot be used.

3. PATCH EDIT

Patch edit/Effects/Dry/Effects balance B

○ Dry/Effects balance B

This parameter determines the balance between the dry (unprocessed) sound and the effect sound of group B.

```
PATCH EFF Balance B
DRY: 50 EFF: 50
```

The following diagram shows how this Effect Balance parameter determines the mix between the sound from group A and the sound of effect group B.

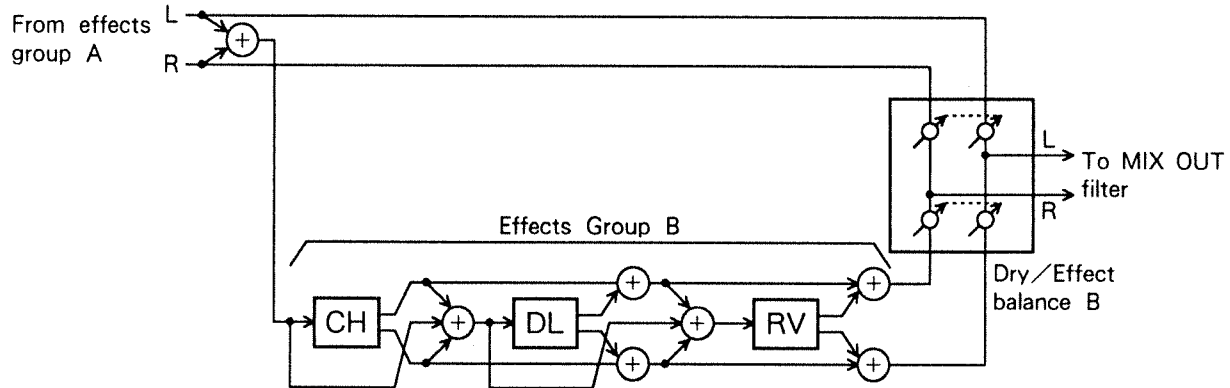

From step ③ of the procedure on page I – 89, use the following procedure.

③ – 1

Use **VALUE** or **INC/YES** and **DEC/NO** to modify the value.

```
PATCH EFF Balance B
DRY 80:EFF 20
```

The DRY and EFF values will always total 100.

[Values] [DRY 100 : EFF 00—DRY 00 : EFF 100]

For a value of DRY:100 and EFF:00, you will hear only the sound from group A. For a value of DRY:00 and EFF:100, you will hear only the processed sound from group B.

*** When set to DRY:00, EFF:100, there will be no sound if all effects are switched off in Switch B.**

○ Distortion setup

Here you can set distortion parameters.

Distortion “clips” the original waveform to create additional harmonics, distorting the sound.

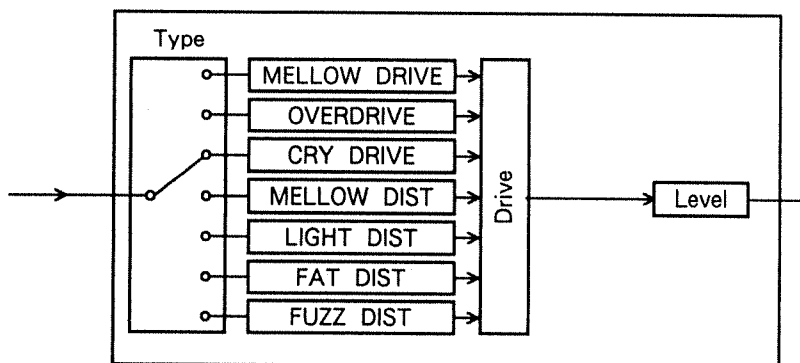

* These settings cannot be made unless distortion is turned on in Switch A.

From step ③ on page I – 89, use the following procedure.

③ – 1

Press **INC/YES**.

```
PATCH EFF/Distortion
Setup ?           [Y/N]
```

③ – 2

Press PAGE **▲** **▼** to select the parameter.

③ – 3

Use **VALUE** or **INC/YES** and **DEC/NO** to modify the blinking value.

③ – 4

Press **EXIT** to return to the display of ③ – 1.

* When distortion is used, complex chords will become muddy. Single notes, or parallel fourths or fifths are best.

Sound idea

Distortion is very effective when you wish to make solo phrases stand out.

3. PATCH EDIT

Patch edit/Effects/Distortion/Type, Drive, Level

◇ Type Select the type of distortion.

```
PATCH EFF/Distortion
Type OVERDRIVE
```

【Values】 [MELLOW DRIVE, OVERDRIVE, CRY DRIVE, MELLOW DIST, LIGHT DIST, FAT DIST, FUZZ DIST]

MELLOW DRIVE : Soft distortion with a rather dark sound.

OVERDRIVE : Distortion similar to that produced by a tube amplifier.

CRY DRIVE : Distortion with emphasis in the high frequency range.

MELLOW DIST : The effect of distortion on a large amplifier.

LIGHT DIST : Strong and bright distortion.

FAT DIST : Low and high ranges are emphasized to create a thick sound.

FUZZ DIST : An even more strongly distorted sound than FAT DIST.

◇ Drive Specify how distortion will be applied (the degree of distortion).

```
PATCH EFF/Distortion
Drive 80
```

【Values】 [0—100]
Higher values will result in a louder effect sound.

◇ Level Specify the overall volume when distortion is used.

```
PATCH EFF/Distortion
Level 100
```

【Values】 [0—100]
Higher values will result in a higher overall volume.

In the distortion effect, higher values of Drive will increase the overall volume as well. This parameter is used to compensate for the volume differences when distortion is switched on/off.

*** For a value of 0, there will be no sound.**

○ Phaser setup

Here you can set phaser parameters.

A modulation effect is created by mixing the original sound with a phase shifted sound.

*** Unless you turn the Phaser on in Switch A, these effect parameters cannot be set.**

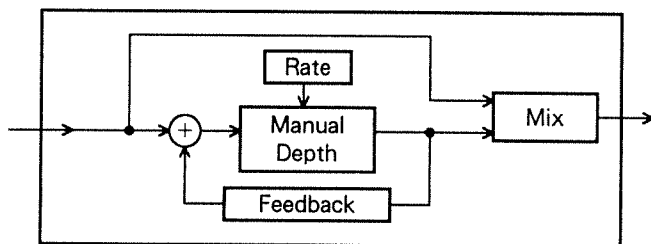

From step ③ on page I – 89, use the following procedure.

③ – 1

Press **INC/YES**.

```
PATCH EFF/Phaser
Setup ? [Y/N]
```

③ – 2

Press PAGE **▲** **▼** to select the parameter.

③ – 3

Use **VALUE** or **INC/YES** and **DEC/NO** to modify the blinking value.

③ – 4

Press **EXIT** to return to the display of step ③ – 1.

Sound idea

The phaser effect artificially shifts the phase of the sound, and mixes this shifted sound with the original sound to create a swirling effect. It is especially effective when used on backing sounds such as electric piano or guitar.

Phasing is most apparent when applied to a sound that includes many higher harmonics. It may be effective to insert the phaser after the distortion or spectrum.

3. PATCH EDIT

Patch edit/Effects/Phaser/Manual, Rate, Depth

◇ Manual Specify the center frequency around which the sound will be modulated.

```
PATCH EFF/Phaser
Manual          1.3kHz
```

For example, the phaser effect will be clearly noticeable if this is set near 1 kHz, where our ears are very sensitive. Set this parameter to the frequency for which you wish to emphasize the “swooshing” of the phaser effect.

【Values】 [50 Hz—15.0 kHz]
Higher values will result in a higher frequency.

◇ Rate Specify the frequency of the phase shifting modulation.

```
PATCH EFF/Phaser
Rate           2.5Hz
```

For slow phasing effect, a value of approximately 2.0 Hz is appropriate.

【Values】 [0.1 Hz—10 Hz]
Specify the value in 0.1 Hz steps from 0.1 Hz to 10 Hz. Higher values will result in faster modulation.

◇ Depth Specify the modulation depth of the phaser effect.

```
PATCH EFF/Phaser
Depth          60
```

【Values】 [0—100]
Higher values will result in an effect of deeper modulation.

◇ Resonance Specify the amount of feedback for the phaser.

```
PATCH EFF/Phaser
Resonance          45
```

【Values】 [0—100]

Higher values will result in a stronger and more distinctive phasing effect.

*** If this value is raised excessively, the sound may become harsh.**

◇ Mix Specify the volume of the phased sound in relation to the direct sound.

```
PATCH EFF/Phaser
Mix                100
```

【Values】 [0—100]

Higher values will result in a louder processed sound.

○ Spectrum setup

Here you can set parameters for the spectrum effect.

Spectrum is an effect that modifies the sound by boosting or cutting specified frequency areas, resulting in different tone colors.

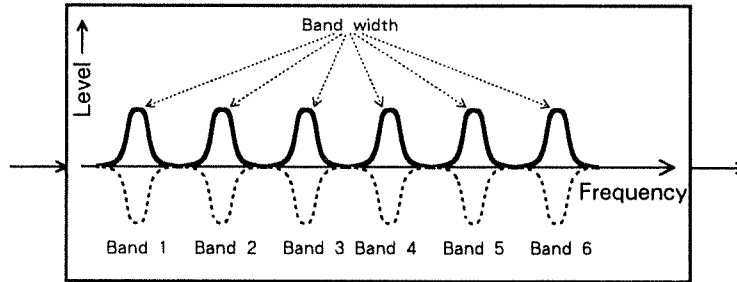

* Unless you turn the Phaser on in Switch A, these effect parameters cannot be set.

From step ③ on page I – 89, use the following procedure.

③– 1

Press **INC/YES**.

```
PATCH EFF/Spectrum
Setup ? [Y/N]
```

③– 2

Press PAGE **▲** **▼** to select the parameter.

③– 3

Use **VALUE** or **INC/YES** and **DEC/NO** to modify the blinking value.

③– 4

Press **EXIT** to select the display of step ③– 1.

Sound idea

This effect is similar to an equalizer, but the frequency of each band has been set at the optimal location for adding a distinctive character to the sound. Thus, rather than “correcting” the sound, this effect allows you to aggressively modify the tonal character.

◇ Band 1—6 control

These parameters control the levels of bands 1—6.

```
PATCH EFF/Spectrum
Band 1 control    +10
```

【Values】 [- 15— + 15]

Positive (+) settings will raise the level, and negative (-) settings will lower the level.

The frequency of each band is fixed as follows.

1: 250 Hz, 2: 500 Hz, 3: 1 kHz, 4: 2 kHz, 5: 4 kHz, 6: 8 kHz

◇ Band width This value is common to all of the frequency bands, and determines the width of the band that will be boosted or cut.

```
PATCH EFF/Spectrum
Band width        05
```

【Values】 [1—5]

Higher values will result in a narrower frequency band.

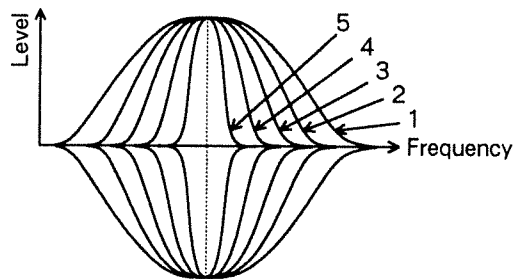
**Sound idea**

As this value is increased, the frequency band becomes narrower, resulting in a more distinctive sound.

3. PATCH EDIT

Patch edit/Effects/Enhancer

○ Enhancer setup

Here you can set parameters for the enhancer effect.

When you select another patch, the Patch data that you have edited, is copied into the temporary area, overwriting the previous data.

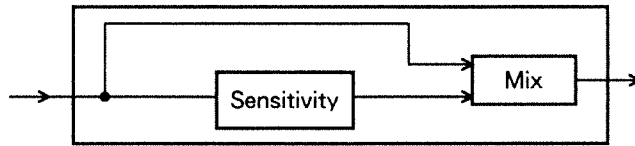

* Unless you turn the Phaser on in Switch A, these effect parameters cannot be set.

From step ③ on page I – 89, use the following procedure.

③– 1

Press **INC/YES**.

```
PATCH EFF/Enhancer
Setup ?           [Y/N]
```

③– 2

Press PAGE **▲** **▼** to select the parameter.

③– 3

Use **VALUE** or **INC/YES** and **DEC/NO** to modify the blinking value.

③– 4

Press **EXIT** to return to the display of step ③– 1.

Sound idea

This is especially effective when applied to a brass or bass sound to make it stand out in the mix.

◇ Sensitivity Specify the depth of the enhancer effect.

```
PATCH EFF/Enhancer  
Sens                    50
```

【Values】 [0—100]

Higher values will result in a more pronounced enhancer effect.

◇ Mix This parameter specifies the mixture of the original sound and the newly generated overtones.

```
PATCH EFF/Enhancer  
Mix                     50
```

【Values】 [0—100]

Higher values will result in a greater level of processed sound.

3. PATCH EDIT

Patch edit/Effects/Chorus

○ Chorus setup

Here you can set parameters for the chorus effect.

Chorus is an effect which combines the direct sound with a slightly delayed processed sound whose pitch is being modulated. This adds depth and spaciousness to the sound.

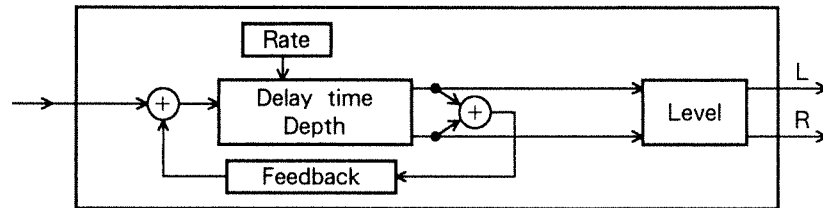

* Unless you turn the Chorus on in Switch B, these effect parameters cannot be set.

From step ③ on page I – 89, use the following procedure.

③ – 1

Press **INC/YES**.

```
PATCH EFF/Chorus
Setup ?           [Y/N]
```

③ – 2

Press PAGE **▲** **▼** to select the parameter.

③ – 3

Use **VALUE** or **INC/YES** and **DEC/NO** to modify the blinking value.

③ – 4

Press **EXIT** to return to the display of step ③ – 1.

* If this effect is used on solo or bass sounds, the sound will become less defined.

Sound idea

This effect is useful for simulating the sound of a large number of instruments, such as a string section. With high settings for Feedback, it can also be used to create a flanging effect.

◇ Rate Specify the rate of chorusing. This determines how fast the sound will be modulated.

```
PATCH EFF/Chorus
Rate 3.5Hz
```

【Values】 [0.1 Hz—10 Hz]
Specify the value in 0.1 Hz steps from 0.1 Hz to 10 Hz.

◇ Depth This parameter specifies the modulation depth of the chorus effect.

```
PATCH EFF/Chorus
Depth 50
```

【Values】 [0—100]
Higher values will result in an effect of deeper modulation.

◇ Delay Specify the delay time used by the chorus. This will determine the character of the chorus effect. Higher values will result in a more spacious effect.

```
PATCH EFF/Chorus
Delay 10ms
```

【Values】 [0.1 ms—50 ms]
0.1—5 ms : Set the value in 0.1 ms steps.
5—10 ms : Set the value in 0.5 ms steps.
10—50 ms : Set the value in 1 ms steps.

Sound idea

To create a flanger-like effect, set this parameter in the range of 1—10 ms.

3. PATCH EDIT

Patch edit/Effects/Chorus/Feedback, Level

◇ Feedback Specify the amount of feedback used by the chorus effect; i.e., the amount of processed signal that is returned to the input and processed again. You can specify positive (+) or negative (-) polarity and amount.

```
PATCH EFF/Chorus
Feedback          +70%
```

【Values】 [- 98 % — + 98 %]

Specify a value in 2% steps over a range of - 98% to +98%. At a value of 0, there will be no feedback.

Sound idea

Negative (-) values will create a more spacious effect.
When using the chorus effect as a flanger, set a fairly high value (approximately $\pm 70\%$) for this parameter.

◇ Level Set the volume level of the chorus sound.

```
PATCH EFF/Chorus
Level          50
```

【Values】 [0—100]

Higher values will result in higher levels of chorus.

*** If this value is 0, there will be no chorus sound.**

○ Delay setup Here you can set parameters for the delay effect.

Delay is an effect that combines the direct sound with a delayed signal, creating richer sounds or echo effects. The JD-800's delay effect is a triple tapped delay that allows you to set three different delay times; center (L+R), left (L), and right (R).

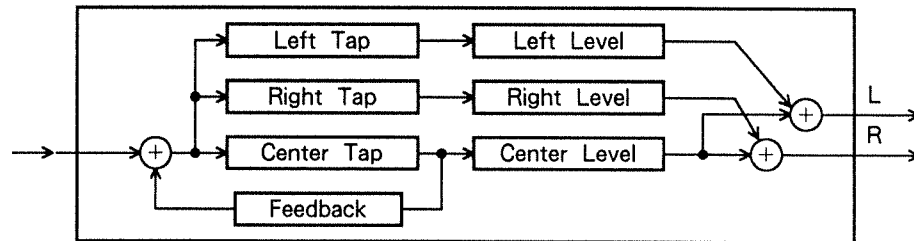

* Unless you turn the Delay on in Switch B, these effect parameters cannot be set.

From step ③ on page I – 89, use the following procedure.

③ – 1

Press **INC/YES**.

```
PATCH EFF/Delay
Setup ?      [Y/N]
```

③ – 2

Press PAGE **▲** **▼** to select the parameter.

③ – 3

Use **VALUE** or **INC/YES** and **DEC/NO** to modify the blinking value.

③ – 4

Press **EXIT** to return to the display of step ③ – 1.

* If you are using mono output, all the delays (center, left, right) will be output from the MONO out jack.

Note

If you are using mono output, the sound of the three delays (center, left, right) will be mixed. In order to clearly hear the triple tapped delay effect, we recommend that you use stereo output.

3. PATCH EDIT

Patch edit/Effects/Delay/Center tap, Center level, Left tap

- ◇ Center tap Specify the delay time for the sound that is output from the center (L+R).

```
PATCH EFF/Delay
Center tap      600ms
```

【Values】 [0.1 ms—600 ms]

- 0.1—5 ms : Specify the value in 0.1 ms steps.
- 5—10 ms : Specify the value in 0.5 ms steps.
- 10—40 ms : Specify the value in 1 ms steps.
- 40—200 ms : Specify the value in 10 ms steps.
- 200—600 ms : Specify the value in 20 ms steps.

- ◇ Center level Specify the level of the delay sound that is output from the center.

```
PATCH EFF/Delay
Center level    50
```

【Values】 [0—100]

Higher values will result in a louder delayed sound in the center.

*** If this value is 0, there will be no delay sound from the center.**

- ◇ Left tap Specify the delay time for the sound that is output from the left (L) side.

```
PATCH EFF/Delay
Left tap       200ms
```

【Values】 [0.1 ms—600 ms]

- 0.1—5 ms : Specify the value in 0.1 ms steps.
- 5—10 ms : Specify the value in 0.5 ms steps.
- 10—40 ms : Specify the value in 1 ms steps.
- 40—200 ms : Specify the value in 10 ms steps.
- 200—600 ms : Specify the value in 20 ms steps.

◇ Left level Specify the level of the delay sound that is output from the left side.

```
PATCH EFF/Delay
Left level      50
```

【Values】 [0—100]

Higher values will result in a louder delayed sound in the left.

*** If this value is 0, there will be no delay sound from the left.**

◇ Right tap Specify the delay time for the delay sound that is output from the right (R) side.

```
PATCH EFF/Delay
Right tap      400ms
```

【Values】 [0.1 ms—600 ms]

0.1—5 ms : Specify the value in 0.1 ms steps.

5—10 ms : Specify the value in 0.5 ms steps.

10—40 ms : Specify the value in 1 ms steps.

40—200 ms : Specify the value in 10 ms steps.

200—600 ms : Specify the value in 20 ms steps.

◇ Right level Specify the level of the delay sound that is output from the right side.

```
PATCH EFF/Delay
Right level    50
```

【Values】 [0—100]

Higher values will result in a louder delayed sound in the right.

*** If this value is 0, there will be no delay sound from the right.**

3. PATCH EDIT

Patch edit/Effects/Delay/Feedback

- ◇ Feedback Specify the amount of feedback for the center delay sound. "Feedback" means to return the delayed sound to the input of the delay circuit. You can specify the percentage and polarity of the signal that is fed back.

```
PATCH EFF/Delay
Feedback          +70%
```

If you apply feedback to the center delay, the fed back sound will also be input to the left and right delays.

- 【Values】** [- 98% — + 98%]
Specify a value in the range of - 98% to +98%, in 2% steps. For a value of 0, there will be no feedback.

- * The delayed sound from the left and right signals will not be fed back.
- * This is not affected by the center level value.

Sound idea

Here are some ideas for using the triple tapped delay.

«Example 1» General-purpose delay (400 ms) output only from the center
 Center tap 400 ms, Center level = 50, Left tap = appropriate, Left level = 0, Right tap = appropriate, Right level = 0, Feedback = +50%

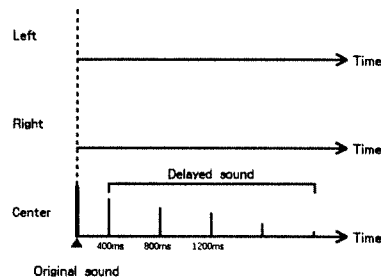

«Example 2» Panning delay with delays at 200 ms intervals from left → right
 Center tap 400 ms, Center level = 0, Left tap = 200 ms, Left level = 50, Right tap = 400 ms, Right level = 50, Feedback = +50%

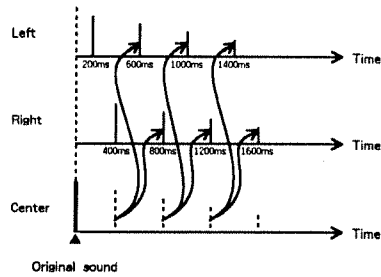

«Example 3» Triple tapped delay with delays at 200 ms intervals from left → right → center
 Center tap 600 ms, Center level = 50, Left tap = 200 ms, Left level = 50, Right tap = 400 ms, Right level = 50, Feedback = +50%

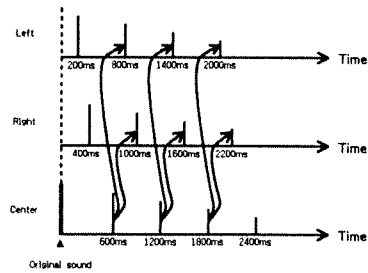

○ Reverb setup

Here you can set parameters for the reverb effect. This effect simulates the ambience characteristics of a wide variety of acoustic environments, such as a concert hall or club. By combining the direct sound with simulated reflections from walls and ceiling, this effect adds spaciousness to the sound.

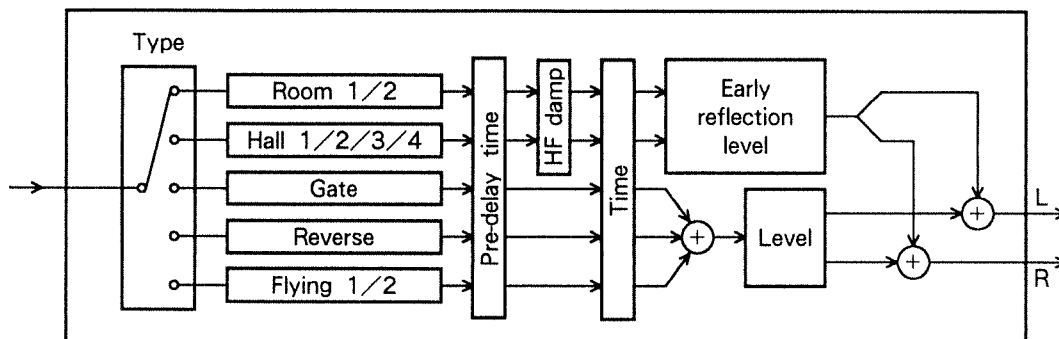

* Unless you turn the Reverb on in Switch B, these effect parameters cannot be set.

《How we hear reverberation》

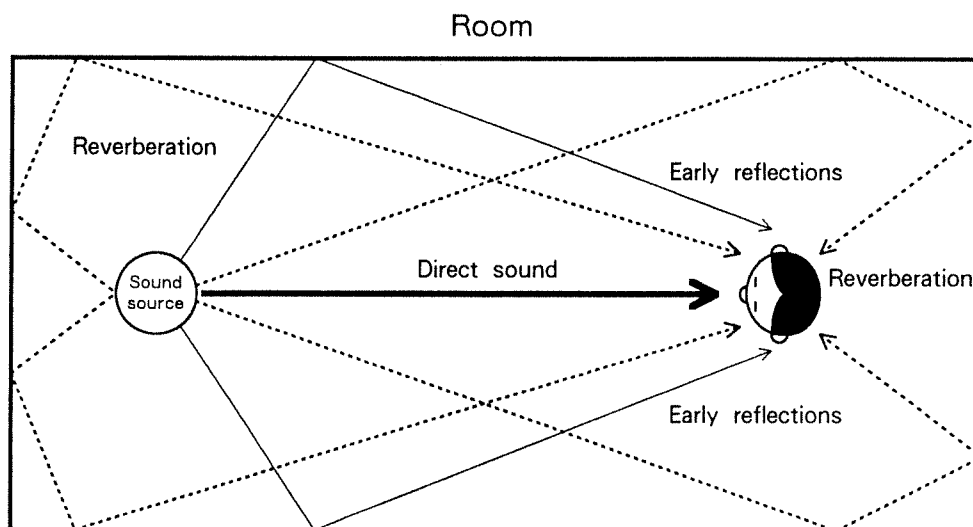

From step ③ on page I – 89, use the following procedure.

③– 1

Press .

```
PATCH EFF/Reverb
Setup ?           [Y/N]
```

③– 2

Press PAGE to select the parameter.

③– 3

Use or and to modify the blinking value.

③– 4

Press to return to the display of step ③– 1.

***If you apply excessive amounts of reverb to sounds which contain a lot of low frequency energy (such as bass or bass drum), the sound will become unfocussed and muddy.**

3. PATCH EDIT

Patch edit/Effects/Reverb/Type, Pre-delay time

◇ Type

Select the type of reverb. This will determine the character of the reverberant sound, resulting from factors such as room size and wall material.

```
PATCH EFF/Reverb
Type          ROOM1
```

[Values] [ROOM 1/2, HALL 1/2/3/4, GATE, REVERSE, FLYING 1/2]

ROOM 1/2 : A reverb effect simulating a room. Room 2 has more reflections and a brighter sound.

HALL 1/2/3/4 : A reverb effect simulating a concert hall. Types 1—4 differ in the size of the reverberant space and the type of reflection.

GATE : A gated reverb effect. The reverberant sound will be muted after a preset time interval.

REVERSE : The reverberant sound will gradually increase, and be muted after a preset time interval.

FLYING 1/2 : The reverberant sound will be panned from left to right (for 1) or right to left (for 2).

● Room/Hall

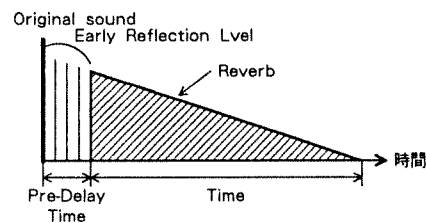

● Gate

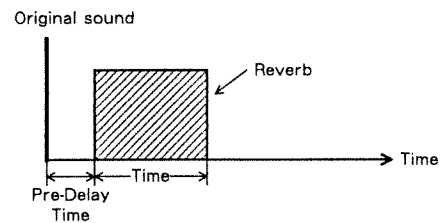

● Reverse

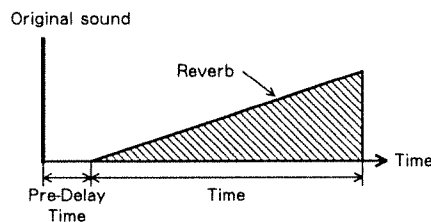

● Flying

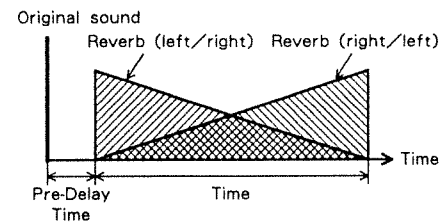

The reverb will be panned from left (right) to right (left)

◇ Pre-delay time

Specify the pre-delay time; the time from when the original sound occurs to when the reverberation is heard. Higher values of this parameter will create the impression of a larger room.

```
PATCH EFF/Reverb
Pre delay time 100ms
```

[Values] [0—120 ms]

Specify the value over the range of 0 to 120 ms, in 1 ms steps.

◇ Early reflection level

Specify the level of the early reflections; the first few reflections from the walls after the direct sound is heard. This determines the subjective distance from the sound source to the walls. Higher values of this parameter will create the impression of a sound source which is close to the walls.

```
PATCH EFF/Reverb
Early ref level    40
```

【Values】 [0—100]

Higher values will increase the level of the early reflections.

*** If you have set Type to GATE/REVERSE/FLYING 1/FLYING 2, this parameter will have no effect.**

*** The Early Reflection Level and Reverb Level are independent. This means that even if Reverb Level is set to 0, you will still hear reverb (Early Reflection).**

◇ HF damp

Specify which portion of the high frequency reverb sound will be cut. Depending on the material, the walls of a room will absorb a certain amount of the high frequencies before reflecting the rest of the sound. The HF damp (high frequency damp) parameter simulates this high frequency absorption.

```
PATCH EFF/Reverb
HF damp           6.3kHz
```

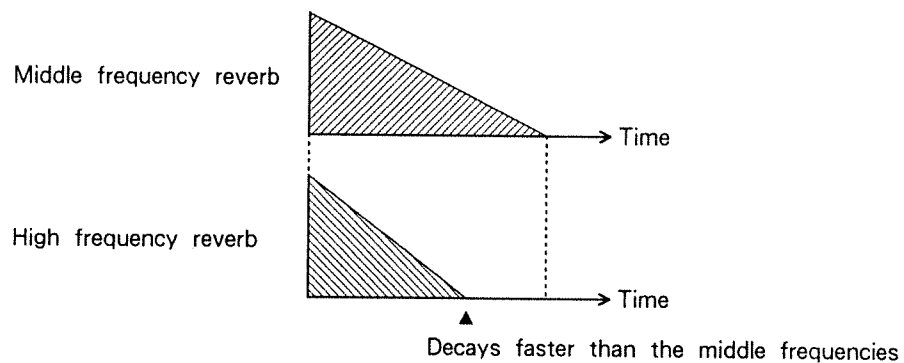

【Values】 [500 Hz—16 kHz, BYPASS]

Specify a frequency between 500 Hz and 16 kHz. When BYPASS is selected, the high frequencies will not be cut. As the frequency is lowered, the reverb will become darker. As the frequency is raised, the reverb will become brighter.

*** If the Reverb type has been set to GATE/REVERSE FLYING 1/FLYING 2, this parameter will have no effect.**

3. PATCH EDIT

Patch edit/Effects/Reverb/Time, Level

- ◇ Time Specify the time over which the reverberant sound will decay. Higher values will result in a longer decay.

```
PATCH EFF/Reverb
Time 5.0s
```

- 【Values】** [0.1 s—10 s] : for Type = ROOM 1/2, HALL 1/2/3/4
[5 ms—500 ms]: for Type = GATE, REVERSE, FLYING 1/2
Specify the value over the range of 0.1 second to 20 seconds.
The settable range of reverb time will depend on the Reverb Type. If GATE reverb is selected, longer Time settings will produce a sparser density of reflections.

- ◇ Level Specify the volume level of the reverberant sound.

```
PATCH EFF/Reverb
Level 70
```

- 【Values】** [0—100]
Higher values will result in a louder reverb sound.

*** Reverb Level and Early Reflection Level are independent. This means that if this value is set to 0 there will be no reverberant sound, but if the Early Reflection Level is set above 0, you will hear the early reflections.**

2) Patch Common settings

In addition to the parameters relating to the tone color, a Patch also contains various performance-related functions, various functions useful for organizing Patches, and several MIDI parameters (MIDI transmit parameters). These parameters are contained in the Common block. The equalizer is also found in this block.

● Patch Common

The Common block contains parameters relating to Patches, and also Tone-related parameters such as Key Range, etc.

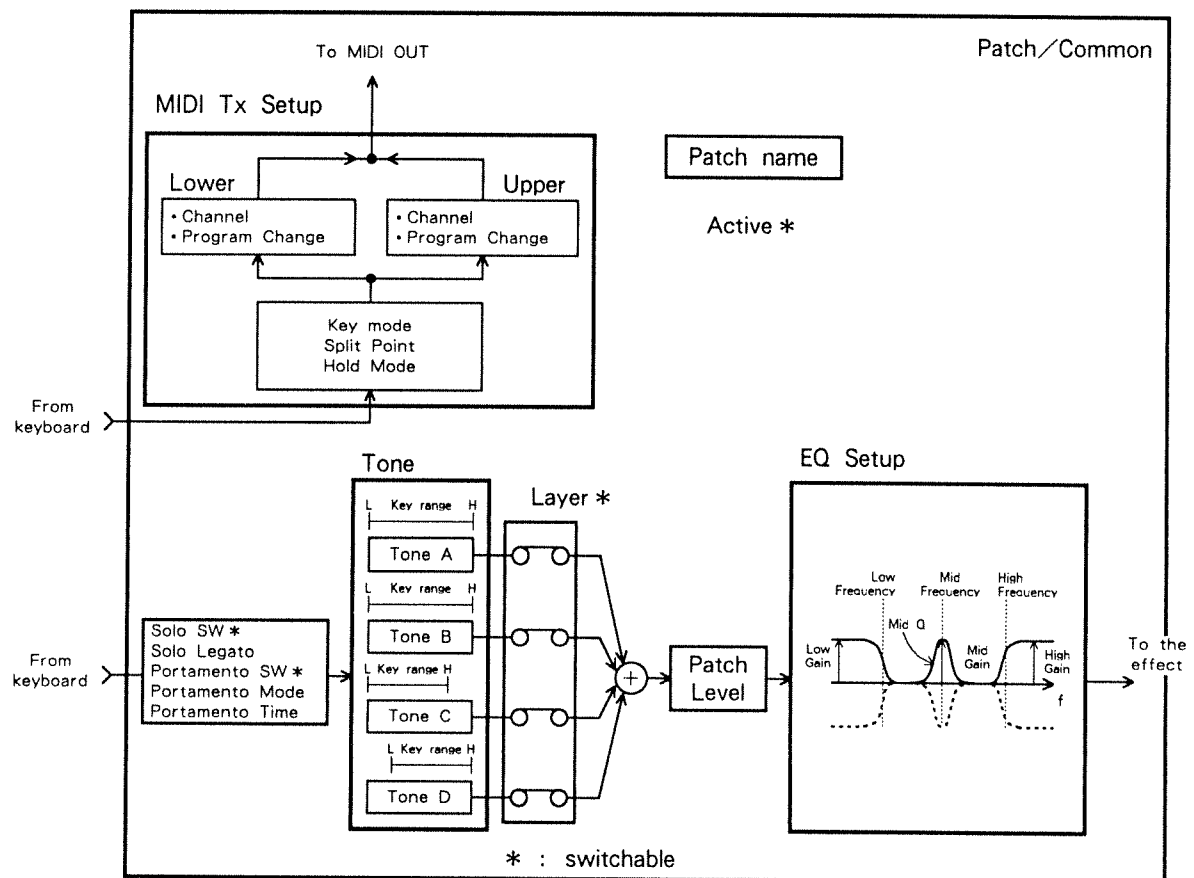

- ① Press **COMMON**.
- ② Use PAGE **▲** **▼** to select a parameter.
- ③ Use **VALUE** or **INC/YES** and **DEC/NO** to modify the blinking value.
- ④ Repeat steps ② and ③ as necessary.
- ⑤ Press **EXIT** to return to the previous play mode.



3. PATCH EDIT

Patch edit/Common/Patch name

○ **Patch name** Here you can name the Patch.

From step ② on page I – 117, use the following procedure.

② – 1

Press CURSOR   to move the blinking “_” (underbar) to select a character. A name can contain up to 16 characters.

```
PATCH COMMON
Name  Dreamin' Night
```

These 80 characters are available.

```
(Space) A B C D E F G H I J K L M N O P Q R S T U V W X Y Z
a b c d e f g h i j k l m n o p q r s t u v w x y z
0 1 2 3 4 5 6 7 8 9 & # ! ? . , : ; ' " * + - / < = >
```

* You can also name each Tone of a Special Setup (☞ P. II – 18).

* It is not possible to name each tone A/B/C/D.

- **Patch level** This parameter specifies the volume of the entire Patch. Use this parameter to compensate for volume differences when you select different Patches.

| | |
|-----------------------|-----|
| PATCH COMMON Level | 100 |
|-----------------------|-----|

【Values】 [0—100]

Higher values will result in a higher volume.

*** In addition to Patch Level, the following parameters also affect volume.**

- ◆TVA Level of each Tone
- ◆TVA Envelope of each Tone
- ◆Level of each Part (only in Multi mode)

3. PATCH EDIT

Patch edit/ Common/ key range A/B/C/D



○ Key range A/B/C/D

These parameters determine the keyboard range over which each Tone will sound. L: indicates the lowest key, and H: indicates the highest key. The keyboard of the JD-800 extends from C2 to C7.

By setting the Key Range of each Tone, you can create layered and split Patches.



In step ② on page I - 117, use the following procedure.

②- 1

Press CURSOR   to select the range L/H: you wish to modify.

```
PATCH COMMON
Range A      L: C-1 H: G9
```

②- 2

Press PAGE   to specify the ranges of other Tones.

```

↑
┌ PATCH COMMON ─┴─┐
│ Range B      L: C-1 H: G9 │
└──────────────────┘
┌ PATCH COMMON ─┴─┐
│ Range C      L: C-1 H: G9 │
└──────────────────┘
┌ PATCH COMMON ─┴─┐
│ Range D      L: C-1 H: G9 │
└──────────────────┘
↓

```

[Values] [C - 1 - G9]

You can specify a keyboard range over the range of C-1 to G9.

- * Depending on the TVA Bias settings (Direction / Point / Level), there may be no sound even in the specified range. In this case, set Bias Level to 0 (⇨ P. I - 71).
- * If you attempt to set the H: key below the L: key, or set the L: key above the H: key, the parameters will change together with the same value. If this happens, re-make the settings as necessary.

Sound idea

For example, by setting two or more Tones to the same Key Range, you can play those Tones simultaneously with the same key. This is called a "layer" Patch.

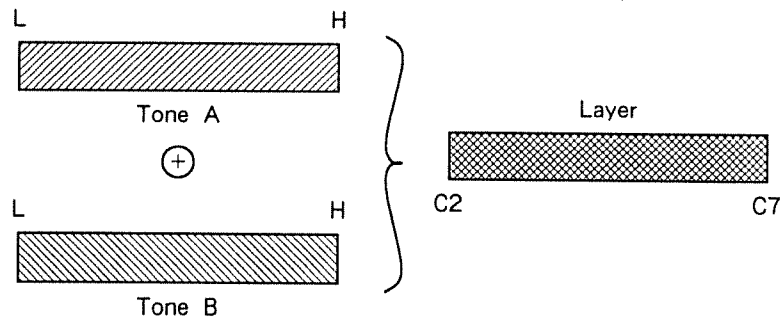

By using two Tones with different Key Range settings, you can play different Tones from different areas of the keyboard. This is called a "split" Patch.

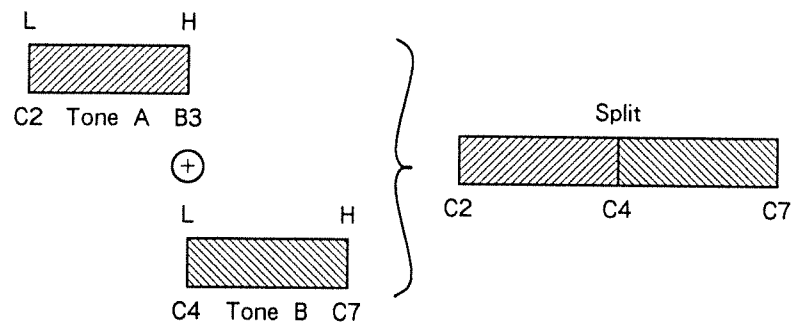

○ Bender range

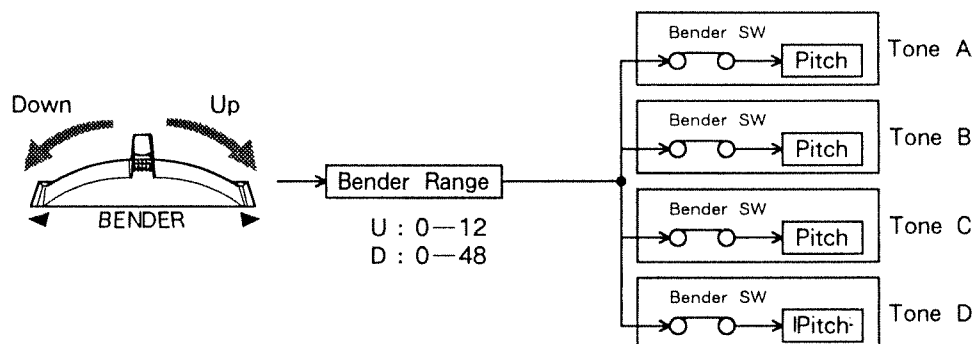

This parameter specifies the amount of pitch change (in chromatic steps) that will occur when you move the bender lever. The pitch of the four Tones will change together. You can independently specify the pitch change that will occur when the bender is moved to the right (Up) or to the left (Down).



```
PATCH COMMON
Bender range D:12 U:02
```

From step ② of page I - 117, use the following procedure.

②-1

Use the CURSOR   keys to select the direction (up or down) for which you want to specify the range.

【Values】 [U : 0—12, D : 0—48]

U:0—12 : Specify the amount of upward pitch bend (in chromatic steps, up to 1 octave) that will occur when you move the bender lever toward the right. For a value of 12, the pitch will rise 1 octave when you move the bender lever all the way to the right. Usually you will set this to 02 (a whole step).

D:0—48 : Specify the amount of downward pitch bend (in chromatic steps, up to 4 octaves) that will occur when you move the bender lever toward the left. For a value of 48, the pitch will fall 4 octaves when you move the bender lever all the way to the left. Usually you will set this to 02 (a whole step).

* Aftertouch can also be used to modify the pitch (☞ next page).

* The pitch will change only for Tones whose Bender Switch Tone parameter (☞ P. I - 34) is on.

* When a MIDI pitch bend message is received, the pitch of the receiving unit will change within the pitch bend range that has been set.

Sound idea

For example, a value of 2 is useful for simulating pitch bending on a guitar. Values of 5 or 7 allow portamento-like effects.

○ Aftertouch bend sensitivity

This parameter allows aftertouch to affect the pitch. Specify the pitch change in units of a chromatic step. The pitch of the four Tones will change together.

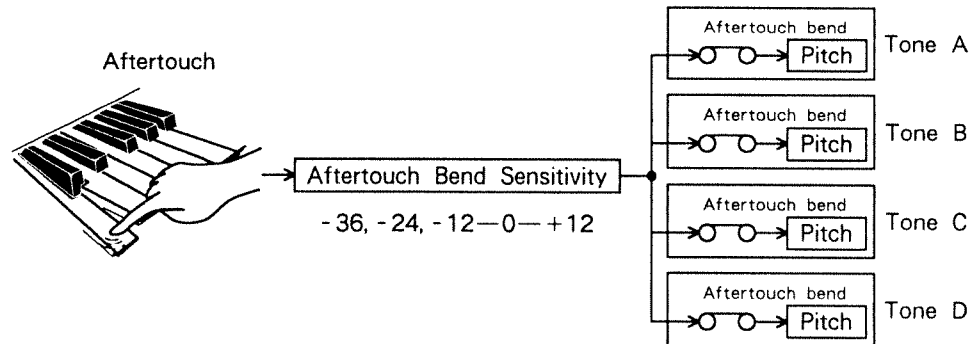

```
PATCH COMMON
A-touch bend sens -36
```

【Values】 [- 36, - 24, - 12-0-+ 12]

For positive (+) values, aftertouch will raise the pitch (maximum rise of 1 octave). For negative (-) values, aftertouch will lower the pitch (maximum fall of 3 octaves). For a value of 0, aftertouch will not affect the pitch.

*** The pitch will change only for Tones whose Aftertouch Bend Tone parameter Switch is on (☑ P. I - 32).**

3. PATCH EDIT

Patch edit/Common/Solo switch

○ Solo switch This parameter specifies whether to apply the Solo effect to the selected Patch. When you press the SOLO switch and then play the keyboard, only the note of the last-played key will sound.

Since this is one of the Patch parameters, if you write (☞ P. I – 83) the Patch with Solo turned on, the Solo effect will always be on when you select that Patch.

① From Play mode or Edit mode, press **SOLO**.

【Values】 [ON, OFF]

ON : The indicator will be lit, and only one note at a time will sound.

OFF : The indicator will be dark, and chords can be played.

* When Solo is on, you can set Solo Legato (☞ next page) to specify how the notes will sound.

* The transmission of a MIDI note message will not be affected by this setting.

Sound idea

This is effective when simulating instruments that are naturally monophonic (such as wind instruments) or when playing synth leads. Portamento (☞ P. I – 126) can also be added.

Note

If the Solo switch is On, key-off velocity will be detected.

For example if you hold the C4 key, press the E4 key, and then release the E4 key, the note C4 will be played with a velocity corresponding to the speed at which you released the E4 key (the key-off velocity). The result will depend on the Velocity Sensitivity and Time Velocity Sensitivity parameters (Pitch envelope, TVF envelope, TVA envelope).

○ **Solo legato** When the Solo function is on, this parameter determines how the sound is produced.

| | |
|--------------|-----|
| PATCH COMMON | |
| Solo legato | OFF |

【Values】 [ON, OFF]

ON : When you play legato, notes will be smoothly connected.

OFF : Regardless of how you play, each note will be sounded separately.

* This parameter is effective only when **SOLO** is on.

* If the TVF/TVA is set to the type of decay sound, in some cases there will be no sound when the solo switch is turned on.

Sound idea

“Legato” refers to the playing technique in which notes are connected smoothly. Legato is effective when playing sounds such as violin.

Solo Legato : when ON

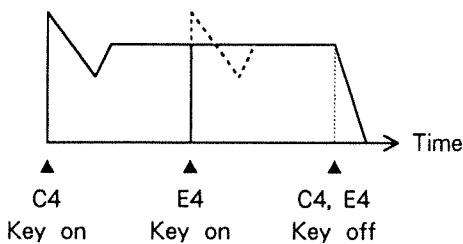

Solo Legato : when OFF

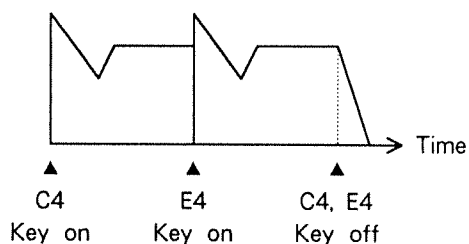

* If the Tones have been split by Key Range settings, in some cases there may be no sound when Solo Legato is turned “on”.

Example) When Tones A and B are split at B3/C4

| | |
|--------|----------|
| Tone A | Tone B |
| C2 | B3 C4 C7 |

In the above situation, holding down the C3 key and then pressing the C5 key will make the C3 note disappear, but the C5 note will not sound. In this case, first release the C3 key, and then press the C5 key to make the C5 note sound.

3. PATCH EDIT

Patch edit/Common/Portamento switch

○ Portamento switch

This parameter determines whether or not portamento will be applied when you select the Patch. Portamento is an effect in which the pitch changes smoothly (over a specified time) from one note to the next.

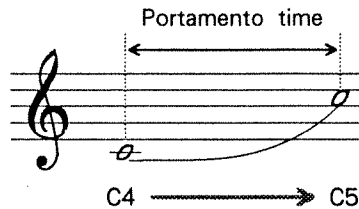

Since this is one of the Patch parameters, if you write (P. I - 83) the Patch with Portamento turned on, the Portamento effect will always be on when you select that Patch.

- ① While SOLO indicator is lit, press PORTAMENTO.

【Values】 [ON, OFF]

ON : The indicator will be lit, and portamento will be applied.

OFF : The indicator will be dark, and portamento will not be applied.

* You can adjust the time and way in which the Portamento effect will change the pitch.

* This parameter is effective only when Solo is on.

* When Solo is on, MIDI Portamento SW messages (control change #65) can be received to turn the effect on/off (MIDI Implementation: P. V - 53).

Sound idea

This parameter can be used to create glissando effects and is therefore effective with voice or trombone sounds, for example.

○ Portamento mode

This allows you to control portamento with your playing technique. The selection of Legato or Normal determines how portamento is applied.

```
PATCH COMMON
Portamento mode NORMAL
```

【Values】 [NORMAL, LEGATO]

NORMAL : Portamento will always be applied, regardless of how you play.

LEGATO : Portamento will be applied only when you play legato: i.e., when you press the next key before releasing the previous key. Portamento will not be applied if you release a note before playing the next note.

C4 E4

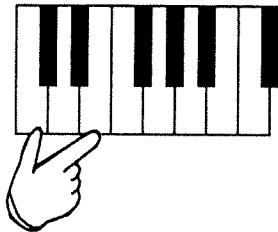

◇ When LEGATO is selected

- ⇒ If you play E4 while holding C4, portamento will be applied.
- ⇒ If you play E4 after releasing C4, portamento will not be applied.

* The time over which portamento will change the pitch is specified by the Portamento Time (☞ next page).

* Portamento is effective only when Solo is on.

3. PATCH EDIT

Patch edit/Common/Portamento time

○ Portamento time

This parameter determines the time over which portamento will change the pitch between notes.

```
PATCH COMMON  
Portamento time 80
```

【Values】 [0—100]

Higher values will result in a longer time over which the pitch will change from one note to the next. For a value of 0, there will be no portamento effect.

*** Portamento is effective only when Solo is on.**

*** While Solo is on, MIDI Portamento Time messages (control change #5) can be received (MIDI Implementation: P. V – 53).**

○ Layer

This determines which Tones will sound, and thus the number of Tones used in a Patch.

The JD-800 is able to produce up to 24 Tones simultaneously. If a Patch uses many Tones, however, you will not be able to play as many notes. For this reason, it is a good idea to turn off unnecessary Tones in a Patch.

Number of Tones and maximum number of notes

| | |
|--------|------------------------|
| 1 Tone | $24 \div 1 = 24$ notes |
| 2 Tone | $24 \div 2 = 12$ notes |
| 3 Tone | $24 \div 3 = 8$ notes |
| 4 Tone | $24 \div 4 = 6$ notes |

* Layer on/off is one of the Patch parameters, and is stored by the Patch Write (\square P. I - 83) operation.

① Press TONE A — TONE D.

【Values】 [ON, OFF]

ON : The indicator is lit, and the Tone will sound.

OFF : The indicator is dark, and the Tone will not sound.

Sound idea

When creating rich sounds or solo sounds, you can turn all four Tones on. By turning all four Tones off, you can create a Patch which will not sound, but can be used to play an external sound source.

3. PATCH EDIT

Patch edit/Common/Active

○ Active

Use the front panel sliders and switches to select the Tone you wish to edit.

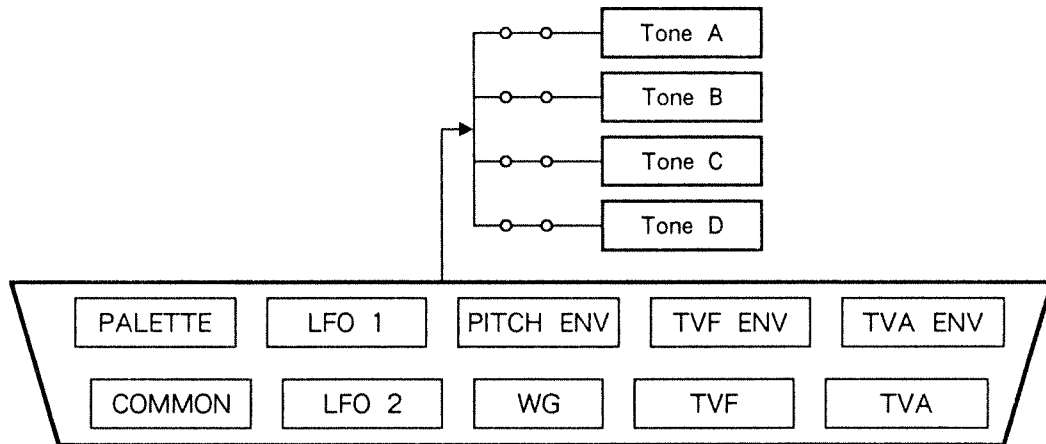

*Since the Active On/Off setting is one of the Patch parameters, the on/off status of each Patch will be stored when you use the Patch Write operation (⇐ P. I – 83).

- ① Press **LAYER ↔ ACTIVE**.

The indicator will change from lit to blinking.

- ② Press the **TONE A** — **TONE D** buttons located below LAYER.

【Values】 [ON, OFF]

ON : The indicator will blink, indicating that the Tone can be edited.

OFF : The indicator will be unlit, indicating that the Tone cannot be edited.

Application ideas By setting all the Tones layered in a Patch to Active ON and writing the Patch, you can use the Tone parameter sliders during a performance to modify the sound as you play. Also, when you turn all tones to active OFF, the values will not change even if you move the sliders. This is convenient for checking the values.

Note : about LAYER ↔ ACTIVE

This button toggles the functions of the **TONE A** — **TONE D** buttons and their indicators, so that they will either be displaying and setting the Layer status or the Active status of the four Tones. If the buttons are displaying and setting the Layer status, the indicators will be lit. If the buttons are displaying and setting the Active status, the indicators will be blinking.

Every time you press **LAYER ↔ ACTIVE**, you can check or change the status of layer/active. This is convenient when tone editing.

● Patch Common / MIDI Tx

These parameters determine how the JD-800 transmits MIDI messages from MIDI OUT. By selecting a Patch, you can change the MIDI transmit channel and transmit a specified Program Change number. This applies only if the MIDI Transmit Channel (☞ P. III – 13) is set to “PATCH”.

These parameters are stored independently for each Patch.

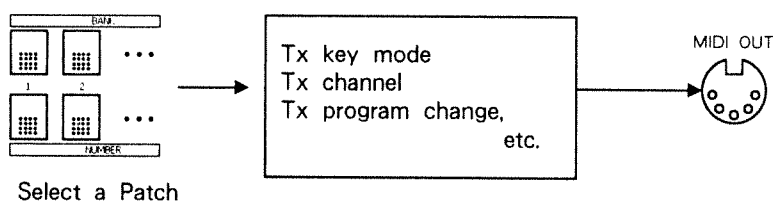

*These settings have an effect only on external MIDI devices, and have no effect on the internal sound source.

- ① Press **COMMON**.
- ② Use the PAGE **▲** **▼** keys to select the following display.

PATCH COMMON/MIDI TX
 Setup ? [Y/N]
- ③ Press **INC/YES**.
- ④ Press PAGE **▲** **▼** to select a parameter.
- ⑤ Use **VALUE** or **INC/YES** and **DEC/NO** to specify the value.
- ⑥ Press **EXIT** to return to the display in step ②.
- ⑦ Press **EXIT** once again to return to play mode.

Sound idea

This is convenient when using the JD-800 as a master keyboard. For example, when you split the keyboard (☞ next page) and set a different program change number to both upper and lower, you can also change the sound of the external sound source (upper and lower) every time you change the patch.

This setting is only for controlling external sound sources, and has no effect on the internal sound source.

3. PATCH EDIT

Patch edit/Common/MIDI TX/Key mode

- Key mode** This parameter selects the mode in which the keyboard will transmit MIDI messages. This Key Mode parameter can be used in a variety of ways.

```
PATCH COMMON/MIDI TX
Key mode          SPLIT
```

【Values】 [SPLIT, DUAL, WHOLE]

SPLIT : The keyboard will be split (into upper and lower ranges) around the specified key, and MIDI messages will be transmitted by each range on its own MIDI channel.

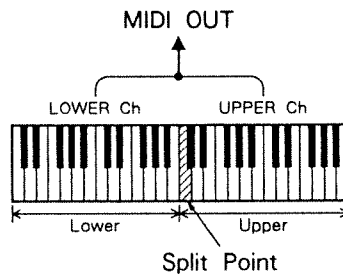

DUAL : The entire keyboard will transmit MIDI messages on both the upper and lower transmit channels.

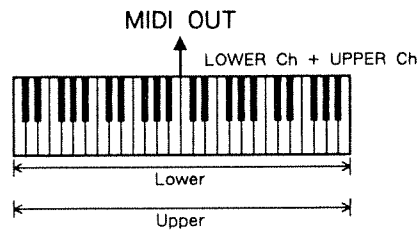

WHOLE : The entire keyboard will transmit MIDI messages on only the upper transmit channel.

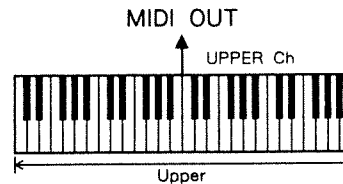

Application ideas ◇SPLIT

Depending on the keyboard range, the JD-800 will control sound module which are receiving two different MIDI channels.

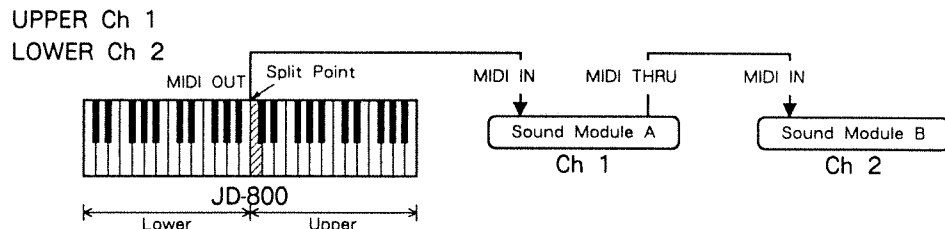

Notes in the Upper area will play sound module A, and notes in the Lower area will play sound module B.

◇DUAL

The JD-800 will control sound module which are receiving two different MIDI channels.

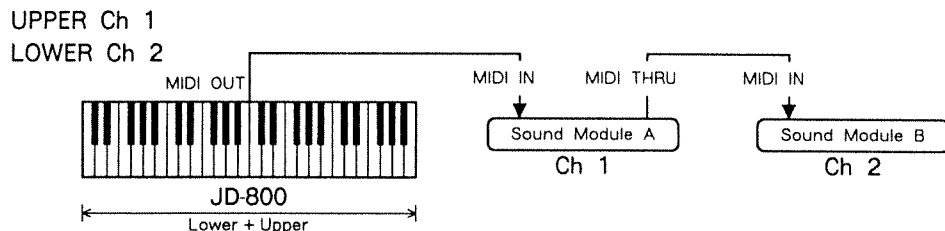

All notes of the keyboard will simultaneously play sound module A and B.

◇WHOLE

The JD-800 will control sound module which are receiving the same MIDI channel.

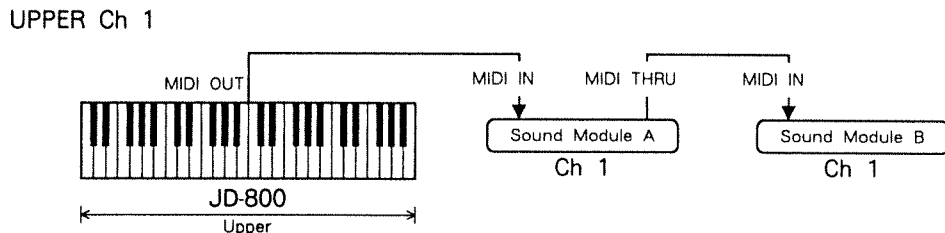

All notes of the keyboard will simultaneously play sound module A and B.

3. PATCH EDIT

Patch edit/Common/MIDI Tx/Split point

- **Split point** This specifies the point at which the keyboard is divided into upper and lower ranges. This is valid only when the Key Mode is "SPLIT".

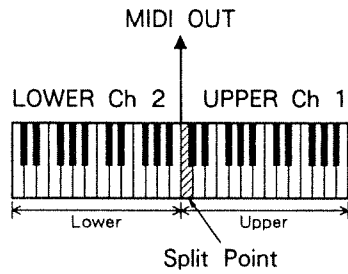

```
PATCH COMMON/MIDI Tx
Split point          C#4
```

- 【Values】** [C1—C # 8]
The specified key and above will be the upper range.

○ Transmit channel

These specify the MIDI transmit channel on which the upper and lower ranges will control external MIDI devices.

These settings are valid only when the MIDI parameter Tx Channel (P. III – 13) is set to PATCH.

When SPLIT is selected

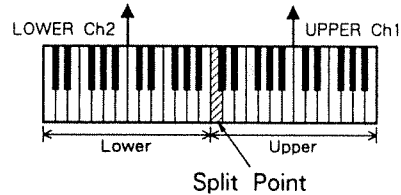

When DUAL is selected

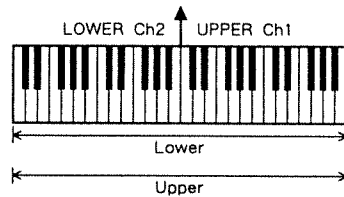

When WHOLE is selected

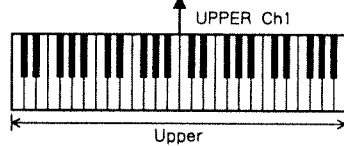

```
PATCH COMMON/MIDI Tx
Channel      L:#02 U:#01
```

From step ④ of page I – 131, use the following procedure.

④ – 1

Press CURSOR to select L (lower)/U (upper).

【Values】 [1 – 16]

“L” indicates Lower, and “U” indicates Upper. Each can be set to any transmit channel 1 – 16.

3. PATCH EDIT

Patch edit/Common/MIDI Tx/Program change number

○ Program change number

Specify the Program Change numbers to be transmitted when you select a Patch.

These settings are valid only if the MIDI parameter Tx channel (P. III – 13) and Tx Prog Change (P. III – 16) has been set to PATCH.

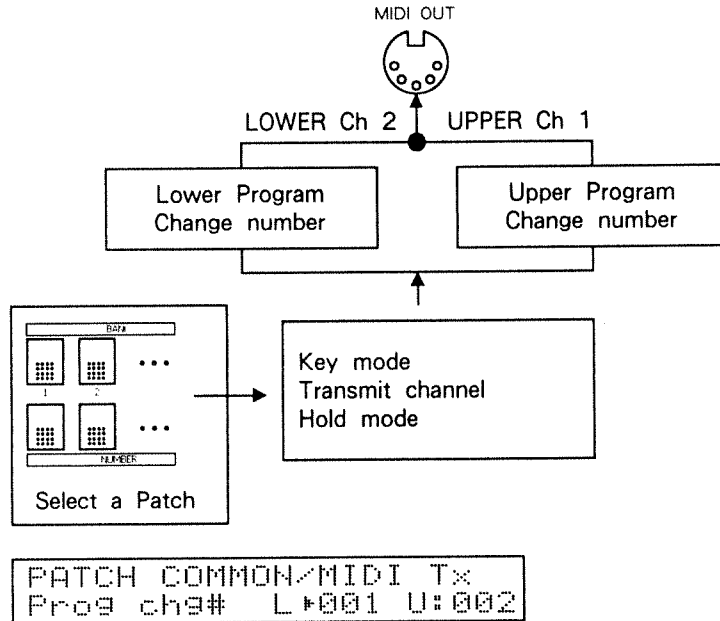

From step ④ of page I – 131, use the following procedure.

④ – 1

Press CURSOR to select L (lower) / U (upper).

[Values] [1 – 128]

Specify the Program Change number 1 – 128 that will be transmitted on the Lower and Upper channels. The program change number that you are setting now will be transmitted from MIDI out.

For example, the diagram below shows how Program Change messages will be transmitted when you select a Patch.

Patch I-11 MIDI Tx

| | |
|------------------|----------------------|
| Key mode | : Split |
| Split point | : C4 |
| Transmit channel | : L : 02 U : 01 |
| Transmit PC # | : L : 001 U : 128 |

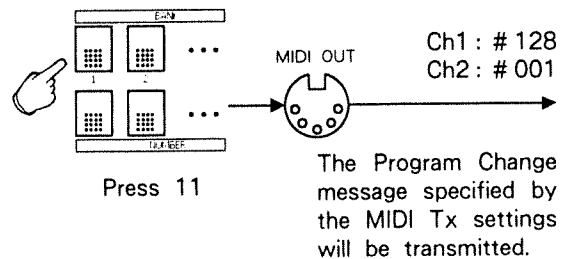

- **Hold mode** This specifies how Hold messages will be transmitted when you select a Patch. These settings are valid only if the MIDI parameter Tx Channel (☞ P. III – 13) has been set to PATCH.

```
PATCH COMMON/MIDI Tx
Hold mode          UPPER
```

When you press the hold pedal (DP-2, etc.), a MIDI Hold message is transmitted, telling the receiving device to sustain the notes. The Hold Mode parameter specifies whether or not Hold messages will be transmitted on the upper/lower channels.

【Values】 [LOWER, UPPER, BOTH]

LOWER : Hold messages will be transmitted on the lower channel.

UPPER : Hold messages will be transmitted on the upper channel.

BOTH : Hold messages will be transmitted on both channels.

《How the Keyboard Mode and Hold Mode are related》

| | Key mode | Split | | Dual | | Whole |
|-----------|------------------|-------|-------|-------|-------|-------|
| | | Lower | Upper | Lower | Upper | Upper |
| | Transmit channel | Lower | Upper | Lower | Upper | Upper |
| Hold mode | LOWER | ○ | × | ○ | × | × |
| | UPPER | × | ○ | × | ○ | ○ |
| | BOTH | ○ | ○ | ○ | ○ | ○ |

○ : Hold messages will be transmitted

× : Hold messages will not be transmitted

Note

◇ The parameter Hold Control (☞ P. I – 15) determines how the internal sound source will respond to incoming Hold messages.

◇ If the MIDI Tx Channel (☞ P. III – 13) is set to “1 – 16” or “RX CH”, Hold messages will always be transmitted on a single channel.

● Patch Common / EQ setup

Here you can make settings for the equalizer that apply to the entire patch.

An equalizer is a type of tone control, and increases or decreases the signal level in specified frequency bands. The JD-800's equalizer has three bands. The lower and high bands are a "shelving" type, and the center band is a "peaking" type.

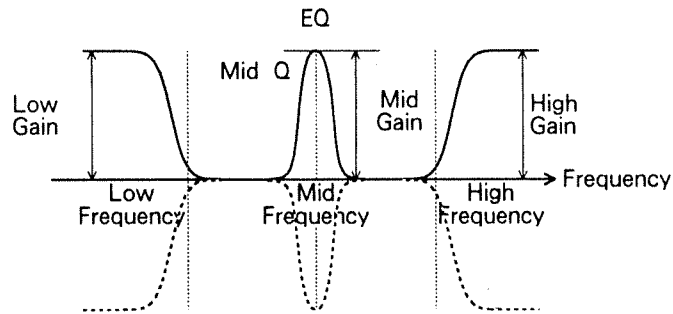

Shelving type : This type of equalizer boosts or cuts all signals above (or below) the specified frequency.

Peaking type : This type of equalizer boosts or cuts the signal over an area (a "frequency band") determined by the Q value and centered at the specified frequency.

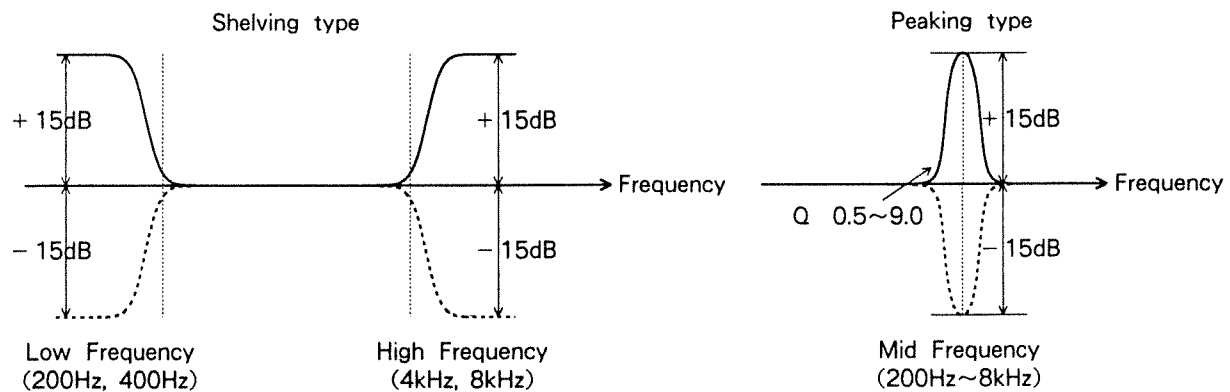

① Press **COMMON**.

② Press PAGE **▲** **▼** to select the following display.

```
PATCH COMMON/EQ
Setup ?          [Y/N]
```

③ Press **INC/YES**.

```
PATCH COMMON/EQ
Low freq         200Hz
```

④ Press PAGE **▲** **▼** to select the parameter.

```
PATCH COMMON/EQ
Low gain         +10dB
```

⑤ Use **VALUE** or **INC/YES** and **DEC/NO** to modify the blinking value.

⑥ Repeat steps ④ and ⑤ as necessary.

⑦ Press **EXIT** to return to the display of step ②.

⑧ Press **EXIT** once again to return to the previous play mode.

3. PATCH EDIT

Patch edit/Common/EQ/Low frequency, Low gain

◇ Low frequency

Select the frequency at which the low range will be boosted or cut.

```
PATCH COMMON/EQ
Low freq          200Hz
```

【Values】 [200 Hz, 400 Hz]

Select a frequency of 200 Hz or 400 Hz.

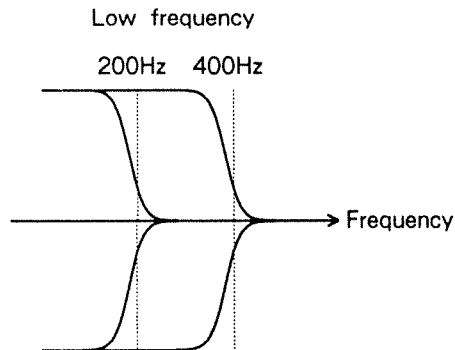

◇ Low gain

Boost or cut the low frequency area.

```
PATCH COMMON/EQ
Low gain          +10dB
```

【Values】 [- 15 dB— + 15 dB]

Specify a value in 1 dB steps over a range of - 15 dB to +15 dB.

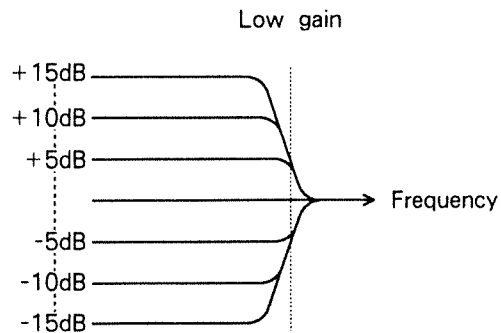

For positive (+) settings the low range will be boosted, resulting in a heavier sound. For negative (-) settings the low range will be cut, resulting in a lighter sound.

◇ Mid frequency

Select the frequency at which the mid range will be boosted or cut.

```
PATCH COMMON/EQ
Mid freq 1.25kHz
```

【Values】 [200 Hz—8 kHz]

Select a frequency from one of the following.

200 Hz, 250 Hz, 315 Hz, 400 Hz, 500 Hz, 630 Hz, 800 Hz, 1 kHz, 1.25 kHz, 1.6 kHz, 2 kHz, 2.5 kHz, 3.15 kHz, 4 kHz, 5 kHz, 6.3 kHz, 8 kHz

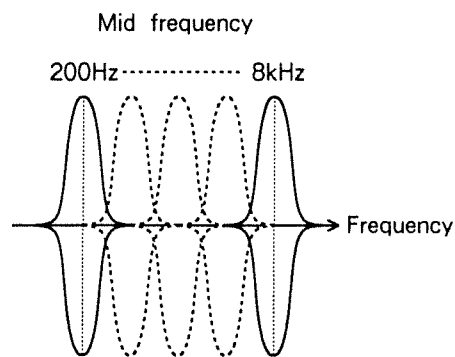

◇ Mid Q

Specify the width of the frequency area (centered on the Mid Frequency) that will be boosted or cut.

```
PATCH COMMON/EQ
Mid Q 4.0
```

【Values】 [0.3—9.0]

Select a band width from one of the following.

0.5, 1.0, 2.0, 4.0, 9.0

Higher values will result in a sharper peak.

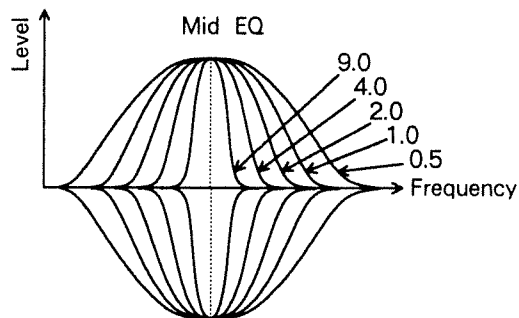

3. PATCH EDIT

Patch edit/Common/EQ/Mid gain, High frequency

◇ Mid gain Boost or cut the frequency area specified by Mid Frequency and Mid Q.

```
PATCH COMMON/EQ
Mid gain      +05dB
```

【Values】 [- 15 dB— + 15 dB]
Specify a value in 1 dB steps over a range of - 15 dB to +15 dB.

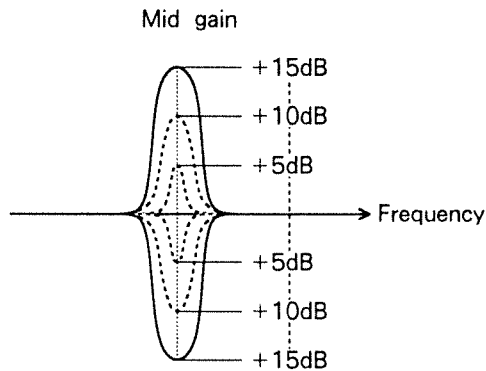

For positive (+) settings the mid range will be boosted, resulting in a more distinctive sound.
For negative (-) settings the mid range will be cut, resulting in a more subdued sound.

◇ High frequency

Select the frequency at which the high range will be boosted or cut.

```
PATCH COMMON/EQ
High freq     8kHz
```

【Values】 [4 kHz, 8 kHz]
Select a frequency of 4 kHz or 8 kHz.

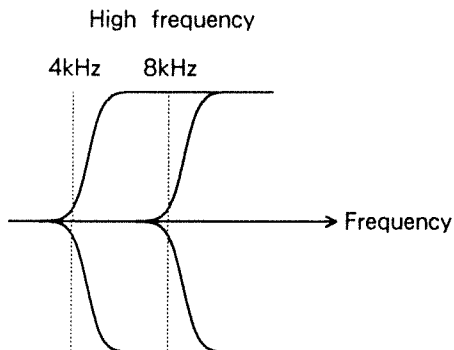

◇ High gain Boost or cut the high frequency range.

```
PATCH COMMON/EQ  
High gain      00dB
```

【Values】 [- 15 dB— + 15 dB]

Specify a value in 1 dB steps over a range of - 15 dB to +15 dB.

High gain

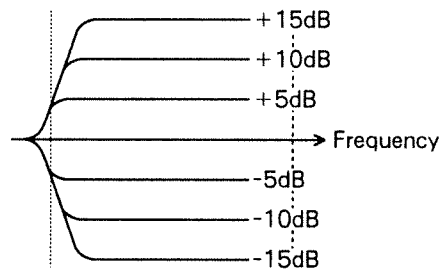

For positive (+) settings the high range will be boosted, resulting in a harsher sound. For negative (-) settings the high range will be cut, resulting in a mellower sound.

【MEMO】

Section II



Multi mode operations

In Multi mode, you can play two or more Patches simultaneously. This is useful when you are using the JD-800 together with an external MIDI sequencer.

1. MULTI MODE

Multi mode is the mode to use when playing the JD-800 from an external device such as a sequencer.

1) Enter Multi mode

Here's how to enter Multi mode.

- ① Press **MULTI**. The indicator will light.

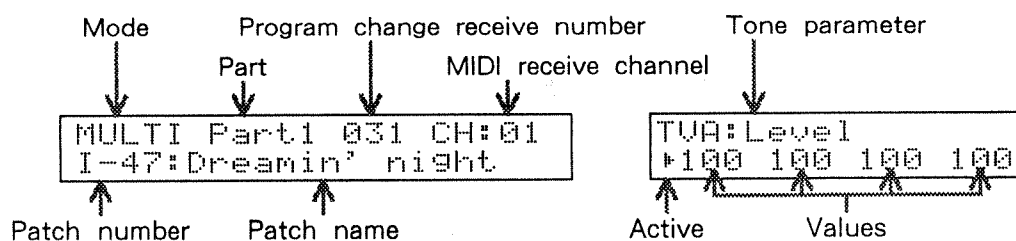

- **Mode** This indicates the current mode. In addition to play mode, this will also display modes such as Edit/Write/Compare/Copy.
- **Part** This indicates the currently selected Part.
- **MIDI channel** This indicates the MIDI receive channel of the currently selected Part.
- **Program change number** This indicates the Program Change number of the selected Patch. Internal Patches I-11 — I-88 correspond to 1 — 64. When a DATA card is used, C-11 — C-88 correspond to 65 — 128.
- **Patch number** This indicates the Patch number. You can use 64 internal Patches I-11 — I-88, and when a DATA card is used, 64 card Patches C-11 — C-88.
- **Patch name** This indicates the name of the selected Patch.
- **Active (▶)** This indicates the Tone that will be edited by front panel sliders and switches.

2) Select a Part

Select the Part you wish to play from the keyboard.

Parts 1 — 5 are Synth Parts, and the Patch that has been assigned to the selected Part can be played from the keyboard. If you select the Special Part, each key of the keyboard will play a different Tone.

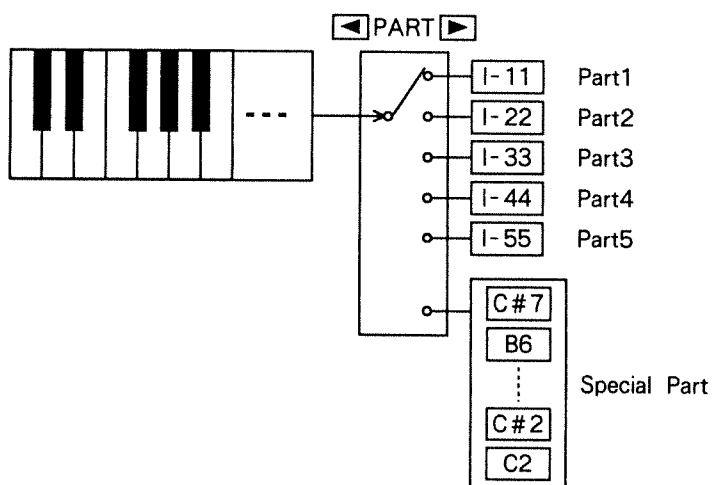

The currently selected Part is referred to as the “current part”. You may think of selecting the current part as moving a selector switch to connect the keyboard with one of the Parts.

- ① Press **◀PART▶** to select the part you wish to play.

```
MULTI Part2 009 CH:02
I-21:Hyper moves
```

The above display will appear if the Special Part is selected.

```
MULTI PartS 001 CH:10
INTERNAL Setup
```

【Values】 [Part1 — 5, PartS]
 Part1 — Part5 : a Synth Part
 PartS : the Special Part

*The current part will remain in memory even if you turn the power off or change modes.

Application ideas If you assign a patch to each part beforehand, you can change patches quickly, simply by pressing **◀PART▶**.

3) Select a Patch

Select the Patch to be assigned to each Part.

- ① Press **INT/CARD** to select the memory, and use BANK **1**—**8** and NUMBER **1**—**8** to select the Patch.

```
MULTI Part1 031 CH:01  
I-47:Dreamin' night
```

【Values】 [I-11 — C-88]

Select any one of the 128 Patches I-11 to C-88.

* If you press **INT/CARD** while there is no card in the DATA card slot, the following display will appear and card Patches cannot be selected.

```
DATA card is not ready
```

* The Patch selected for each Part are remembered even when the power is turned off.

* Patches can be selected by MIDI Program change messages received from an external device.

Note

You can press **INT/CARD** to select an internal or DATA card setup for the Special Part as well.

Internal setup

```
MULTI Parts 001 CH:10  
INTERNAL Setup
```

Press **INT/CARD**, and the setup from the DATA card will be selected.

```
MULTI Parts 002 CH:10  
CARD Setup
```

Setups can also be selected by incoming Program Change messages from MIDI IN. Program change number 001 will select the internal setup, and program change number 002 will select the DATA card setup.

2. EDITING IN MULTI MODE

1) How Multi mode is organized

In Multi mode, the JD-800 can produce five Parts and a Special Part. Each of the Parts has its own Patch assigned to it. The Special Part is organized differently (☞ P. II – 6). The same Patches are used in both Single mode and Multi mode. However, the Patch effect settings used in Single mode are ignored when that Patch is used in Multi mode.

Multi mode includes Part edit, Effects edit, Special Setup edit, and also allows you to edit the current Patch or Tone.

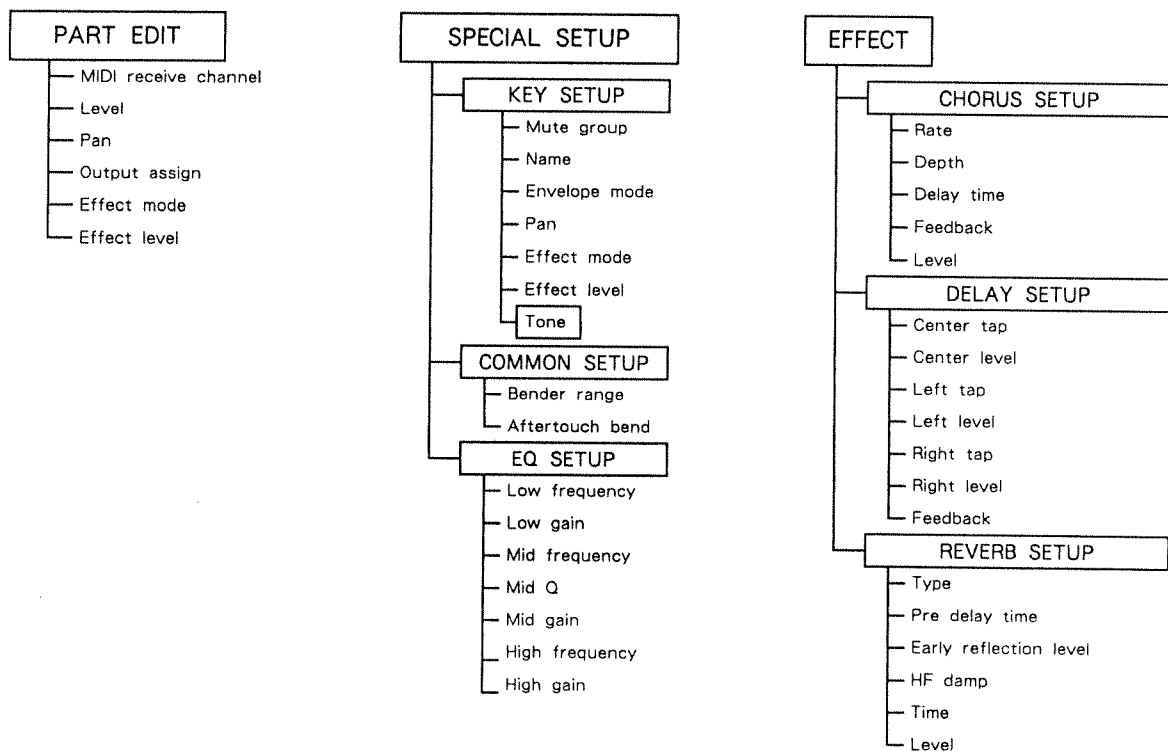

Note

● Tone edit

Even while in Multi mode, you can edit the Tones in the Patch of the current Part, just as in Single mode. For the editing procedure, refer to Single mode “Tone editing” (☞ P. I – 4).

● Patch edit

Even while in Multi mode, you can edit the Patch of the current Part, just as in Single mode. For the editing procedure, refer to Single mode “Patch editing” (☞ P. I – 81) however, patch effects cannot be set.

2) Part edit

Part Edit allows you to edit the various part-related parameters.

● How a Part is organized

A Part contains the assigned Patch, Level, MIDI channel, and effect-related parameters.

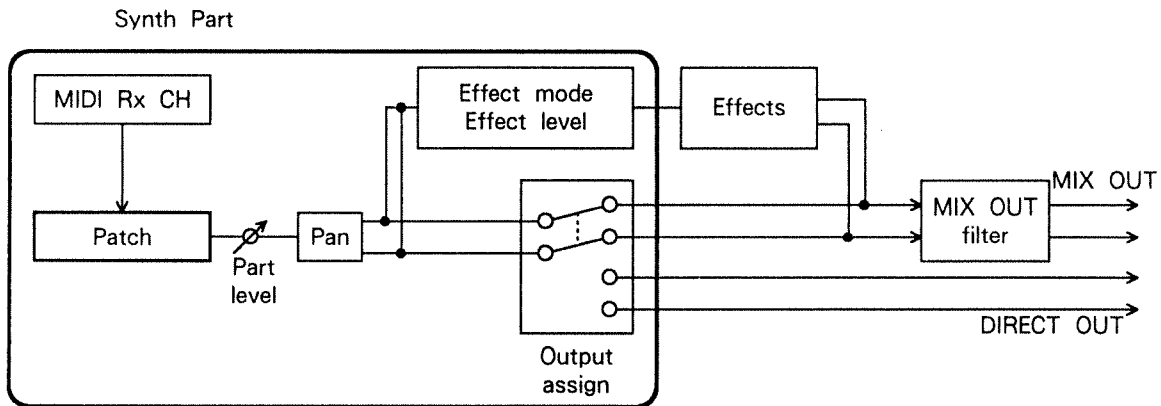

- * Program Change messages can be received even during Part Edit.
- * Changes you make in these settings are written directly into internal (INT) memory. There is no need to use the Write operation.
- * Only the following parameters can be set in the Special Part: MIDI Rx CH, part level and output assign. Refer to “4) Special Setup edit” (P. II - 14) for additional parameter settings.

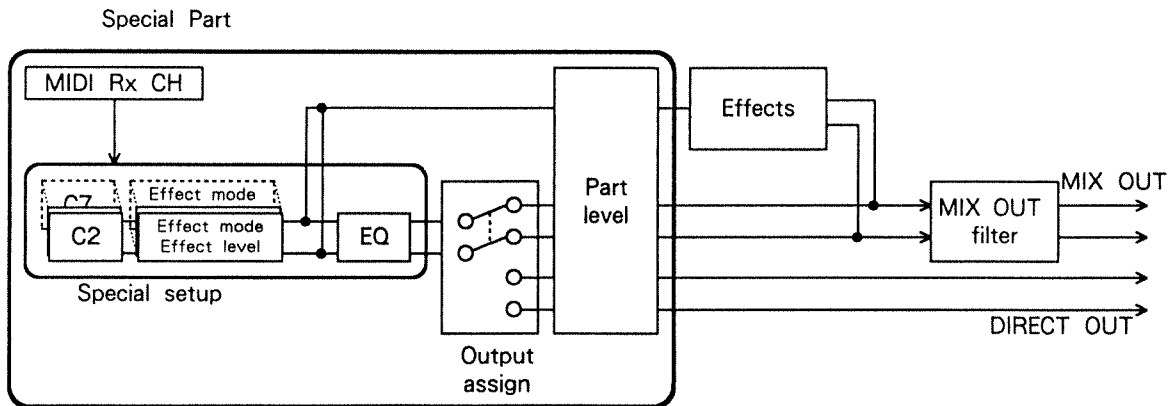

- ① Press **PART EDIT**.

```

PART EDIT Part1
MIDI Rx Channel    01
  
```

- ② Press PAGE **▲** **▼** to select a parameter.

```

PART EDIT Part1
Pan                L30
  
```

- ③ Use **VALUE** or **INC/YES** and **DEC/NO** to modify the value.

- ④ You can use **◀** **PART** **▶** to select the Part.

```

PART EDIT Part4
Pan                10R
  
```

- ⑤ Repeat steps ② to ④ as necessary.

- ⑥ Press **EXIT** to return to Multi mode.

*** Program change messages will be received even while in the PART EDIT mode.**

2. EDITING IN MULTI MODE

Part edit / MIDI receive channel

○ MIDI receive channel

When connecting a sequencer etc. to control (play) each Part from an external MIDI device, specify the MIDI receive channels.

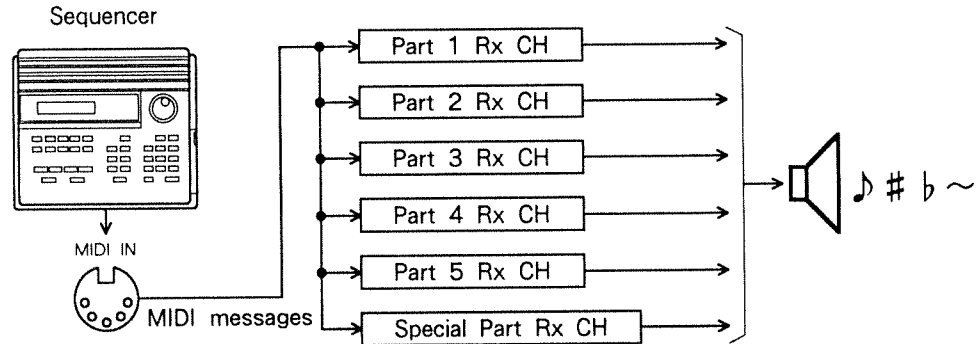

```

PART EDIT Part1
MIDI Rx Channel  01
    
```

【Values】 [1—16, OFF]

- 1—16 : Each Part will play in response to the MIDI channel it receives.
- OFF : The Part will not respond to messages from MIDI IN.

* The current part will be heard when you play the keyboard even if it is set to off.

* With the factory settings, the Part receive channels are as follows.

Part 1 : 01
Part 2 : 02
Part 3 : 03
Part 4 : 04
Part 5 : 05
Special Part : 10

* If the receive channel of the current Part is OFF, and the MIDI transmit channel (P. III - 13) is "PART", MIDI messages will not be transmitted from MIDI OUT. (The internal sound source will sound.)

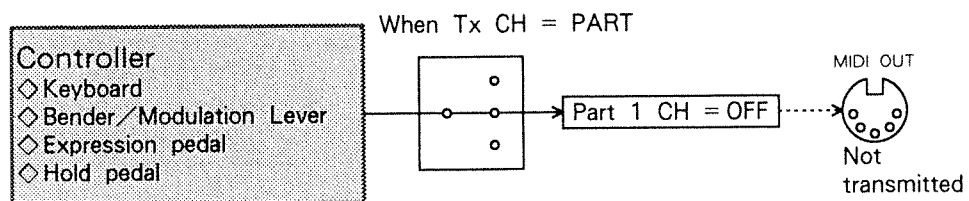

○ Level

Specify the level of each Part. In Multi mode, set the volume balance of the parts using the Part levels. For the Special Part, this will be the overall volume of the entire Part.

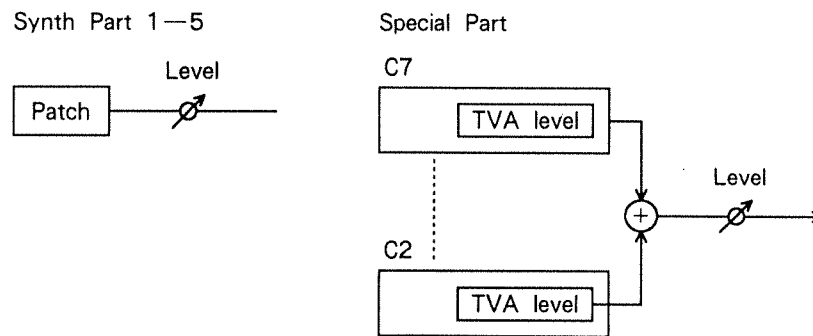

```
PART EDIT Part1
Level          100
```

【Values】 [0—100]

Higher values will result in a louder volume for the Part.

- * When MIDI Volume messages are received, the value of this parameter will change.
- * For the Special Part, the volume of each key is determined by the TVA Level (P. I - 67) of the Tone.

2. EDITING IN MULTI MODE

Part edit/Pan

○ Pan

Specify the pan (stereo position) of each Part.

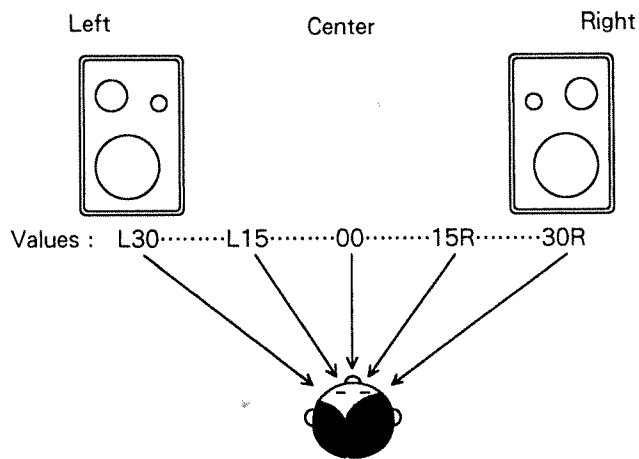

```
PART EDIT Part1  
Pan L30
```

【Values】 [L30—00—30R]

30R : Panned to far right.

00 : Panned to center.

L30 : Panned to far left.

* When MIDI Pan messages are received, the value of this parameter will change.

* It is not possible to specify overall pan for the Special Part. In the Special Part, you can specify Pan for the Tone of each key in the Special Key Setup (☞ P. II - 20).

○ Output assign

Specify which of the two pair of stereo outputs the sound will be sent from.

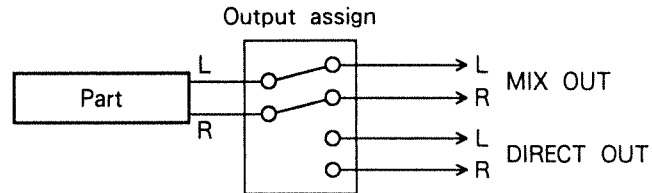

```

PART EDIT Part1
Output assign    MIX
  
```

【Values】 [MIX, DIR]

MIX : The original (direct) sound and effects processed sound will be combined and output from the MIX OUT jacks.

DIR : Only the original sound will be sent from the DIRECT OUT jacks.

*** If this is set to DIR, the internal effects will not be applied. Use this setting when you wish to use only external effect devices.**

*** Even if you select DIR, the sound of that Part will be output from MIX OUT if no cables are connected to the DIR OUT jacks.**

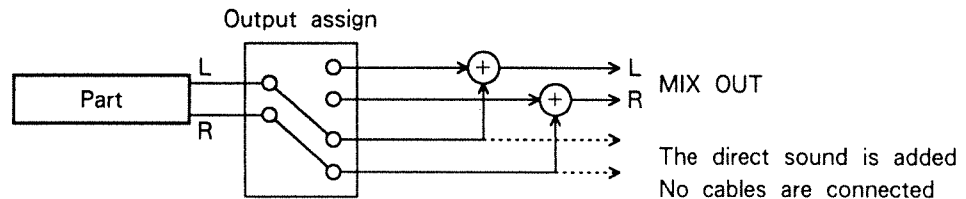

2. EDITING IN MULTI MODE

Part edit/Effect mode

○ Effect mode

Select the effect you wish to apply to the Part.

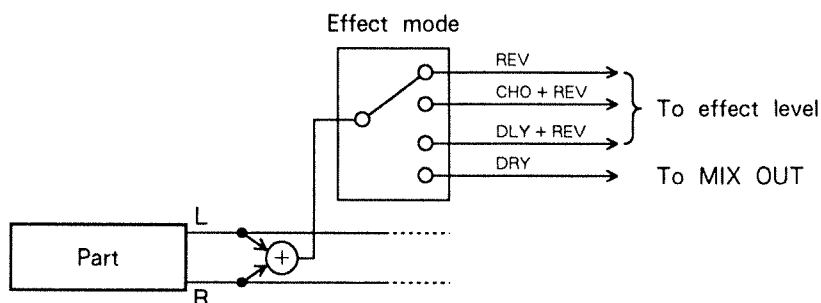

```
PART EDIT Part1
Effect mode      REV
```

【Values】 [DRY, REV, CHO + REV, DLY + REV]

DRY : Only the original sound will be output, and effects will not be applied.

REV : The original sound and reverb sound will be combined.

CHO+REV : The original sound and chorus/reverb sound will be combined.

DLY+REV : The original sound and delay/reverb sound will be combined.

***This setting is valid only if "MIX" is selected for the Output Assign parameter of the previous page. It has no effect if "DIR" is selected.**

***It is not possible to specify the Effect Mode for the entire Special Part. You can make Effect Mode settings for each key (Tone) in the Special Key Setup (☞ P. II - 21).**

- **Effect level** When one of the three effect systems has been selected in Effect Mode, specify the level of the signal sent to the effects. This will adjust the level of the effects.

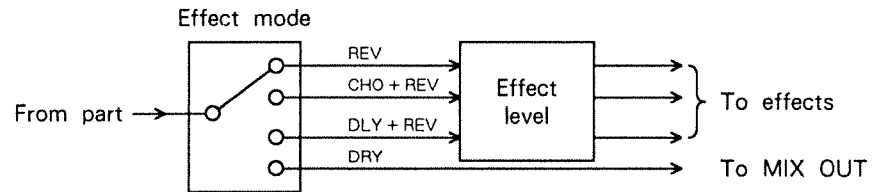

```

PART EDIT Part1
Effect level    100
  
```

【Values】 [0—100]

Higher values will result in a louder effect being applied to the Part.

- * This setting is valid only if “MIX” is selected for the Output Assign parameter of the previous page. It has no effect if “DIR” is selected.
- * It is not possible to specify the Effect Level for the entire Special Part. You can make Effect Level settings for each key (Tone) in the Special Key Setup (☞ P. II - 22).

3) Special Setup edit

In the Special Part, you can create a Tone for each key, and make settings for pan, etc.

● How a Special Setup is organized

The setups of common, EQ, and key are contained in the Special Setup.

Key Setup parameters are independent for each key.

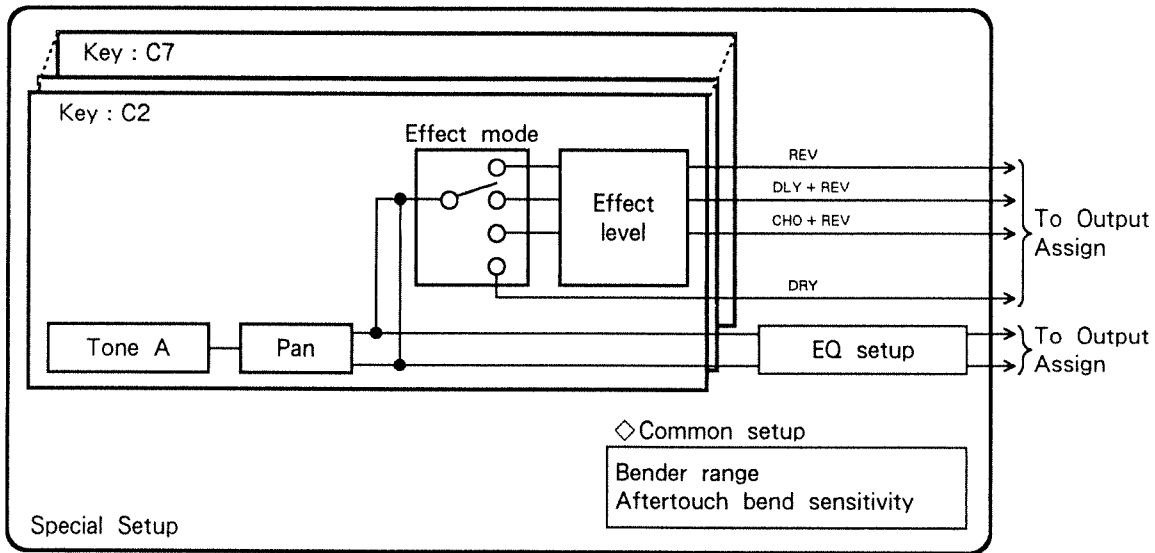

*** Program Change messages will not be received during Special Setup Edit.**

Note

The data in a Special Setup is first read from internal memory into the temporary area. Since the data in the temporary area is used to produce sound, it is not possible to play DATA card Tones and internal Tones simultaneously. If you want to use both internal and DATA card Tones, use the Copy operation (☞ P. II - 30) to copy Tones from the DATA card into the temporary area.

Internal Key Setup memory

| | | | |
|----|-----|-------|----|
| C2 | C#2 | | C7 |
|----|-----|-------|----|

Key Setup temporary area

| |
|----|
| C4 |
|----|

DATA card Key Setup memory

| |
|----|
| C4 |
|----|

Copy Key Setup data from a card



All data is transferred when the power is turned on

○ Key setup

Here you can make settings for each key. The following eight parameters can be set;



You can set the following parameters:

Key name, Mute group, Envelope mode, Pan, Effect mode, Effect level, Tone edit, Tone parameter

In step ③ after entering the Key Setup display, press the key you wish to edit, press PAGE   to select the parameter, and modify the value.

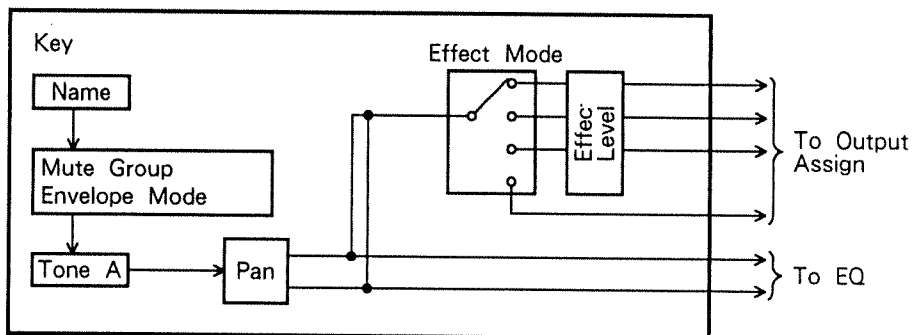
* If you wish to keep the modified settings, use the Setup Write (P. II - 29) operation.

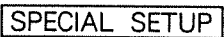



- ① Press .
- ② Press PAGE   to select the "KEY Setup ?" display.

```
SPECIAL KEY
Setup ?      [Y/N]
```

- ③ Press .

```
S.KEY[C2:BassDrum 1]  TUA:Level
Mute group           OFF  *100  --  --  --
```

In the left display, the upper line shows the name of the key you played, and the lower line shows the parameter. The right display shows Tone parameters.

- ④ Press PAGE   to select a parameter, then play the keyboard to select the key you wish to edit.

```
S.KEY[C2:BassDrum 1]
Name           BassDrum 1
```

2. EDITING IN MULTI MODE

Special Setup edit/Key

- ⑤ Use **VALUE** or **INC/YES** and **DEC/NO** to set the value.
- ⑥ Repeat steps ④ and ⑤ as necessary.
- ⑦ Press **EXIT** to return to the display of step ②.
- ⑧ Press **EXIT** once again to return to Multi mode.

- ◇ Mute group This specifies the group of keys that will always be played with last-note priority. When a note in a group is played, any other currently sounding note in the same group will be muted.

```
S.KEY[C2:BassDrum 1]
Mute group OFF
```

【Values】 [OFF, A—H]

OFF : The key will not be affected by a group.

A—H : The key will belong to the specified group.

Sound idea

Some drum sounds never occur simultaneously. For example, it is not possible for an open hi-hat sound and a closed hi-hat sound to be played simultaneously. This parameter allows you to assign such Tones to the same group, so that they will be played with last-note priority.

Certain Latin Percussion sounds should also be grouped in this manner (eg. conga, bongos, cowbells, cuica, etc.).

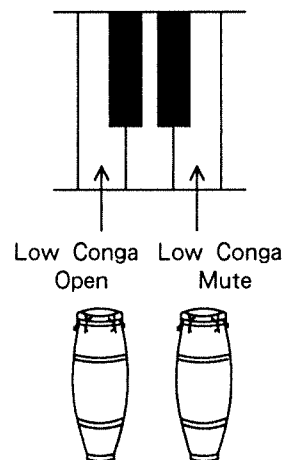

Set both to the same Mute Group (for example, Mute Group B) so that both sounds will not occur simultaneously.



2. EDITING IN MULTI MODE

Special Setup edit/Key/Tone name

◇ Tone name You can assign a 10-character name to the key being edited.

From step ④ on page II – 15, use the following procedure.

④ – 1

Press CURSOR   to move the underbar “_” to select the character you wish to change.

```
S.KEY[C2: BassDrum 1]
Name      BassDrum 1
```

These 80 characters are available.

```
(Space) A B C D E F G H I J K L M N O P Q R S T U V W X Y Z
a b c d e f g h i j k l m n o p q r s t u v w x y z
0 1 2 3 4 5 6 7 8 9 & # ! ? . , ; ' " * + - / < = >
```

◇ Envelope mode

This specifies whether or not the Pitch/TVF/TVA envelopes of a Tone will ignore the Sustain Level (SusL) time.

```
S.KEY[C2#BassDrum 1]
ENV mode          SUSTAIN
```

【Values】 [SUSTAIN, NO SUSTAIN]

SUSTAIN : The sustain level will be held until key-off.

NO SUSTAIN : The sustain level will not be held.

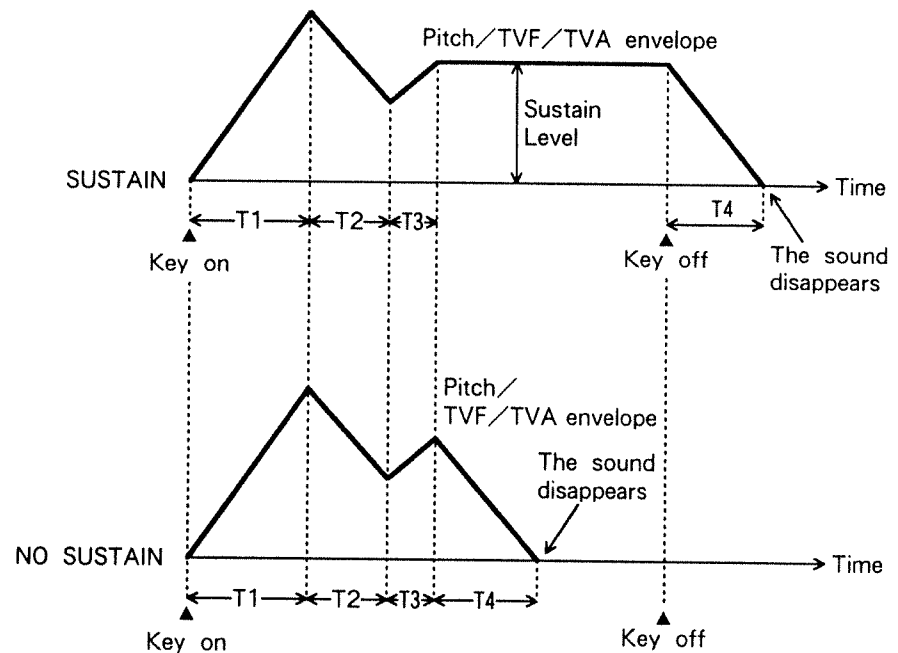

As shown in the above diagram, if SUSTAIN is selected, the sustain level will be held until the key is released. If NO SUSTAIN is selected, the level will begin decreasing immediately after the sustain level is reached, without waiting for the key to be released. This means that notes will always sound for a fixed length of time ($T1+T2+T3+T4$).

Sound idea

When playing the JD-800 from a sequencer, the gate time (the time between note-on and note-off) will be ignored if you select NO SUSTAIN. This may be useful for creating mechanical-sounding phrases. When creating rhythm sounds, it is usually best to select NO SUSTAIN.

2. EDITING IN MULTI MODE

Special Setup edit/Key/Pan

◇ Pan Specify the pan (stereo position) of the Tone.

```
PartS [ C2:BassDrum 1 ]
Pan L15
```

【Values】 [L30—00—30R]

30R : Panned to far right.

00 : Panned to center.

L30 : Panned to far left.

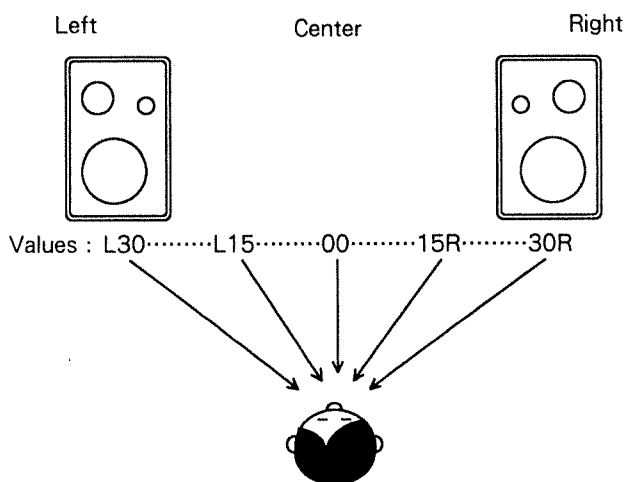

* It is not possible to set the pan of the entire Special Part.

* The Special Part will not respond to MIDI Pan messages.

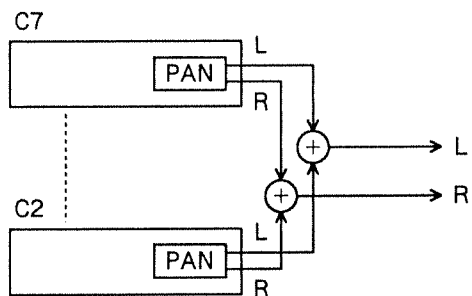

◇ Effect mode Select the effect to be applied to the key.

```
S.KEY[C2:BassDrum 1]
Effect mode CHO+REV
```

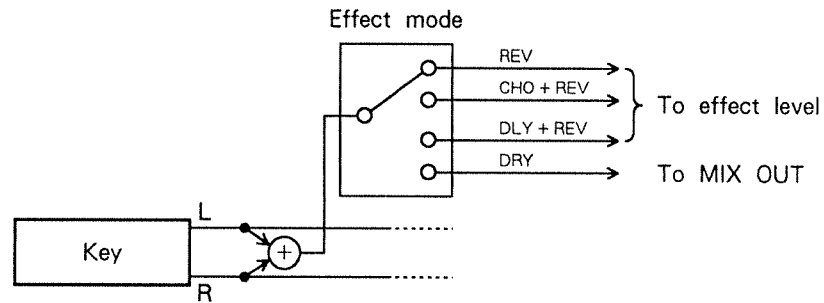

【Values】 [DRY, REV, CHO + REV, DLY + REV]

DRY : Only the original sound will be output, and effects will not be applied.

REV : The original sound will be mixed with the reverb sound.

CHO + REV : The original sound will be mixed with chorus/reverb sound.

DLY + REV : The original sound will be mixed with delay/reverb sound.

* It is not possible to set the Effect Mode for the entire Special Part.

* If you wish to apply the effect you selected here, set the Output Assign (P. II - 11) of the Special Part to "MIX".

* Even if you set the Output Assign of the Part to "DIR", the sound will be output from the MIX OUT jacks unless cables are connected to the DIRECT OUT jacks.

2. EDITING IN MULTI MODE

Special Setup edit/Key/Effect level

- ◇ Effect level Specify the input level for the effect you selected in Effect Mode. You can adjust the amount of effect independently for each key.

```
S.KEY[C2:BassDrum 1]
Effect level 50
```

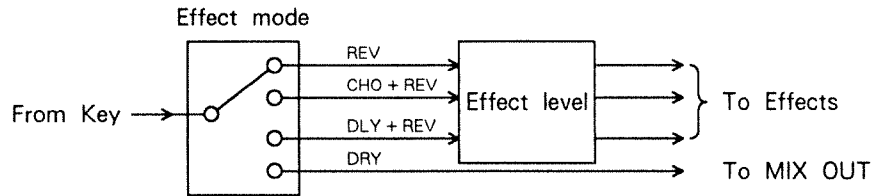

【Values】 [0—100]

Higher values will result in a greater amount of effect being applied to the key.

*** It is not possible to set an overall Effect Level for the entire Special Part.**

- ◇ Tone edit The sound of each key in a Special Part consists of one Tone.
 Only Tone A will always sound (Layer On), and can always be edited (Active On).

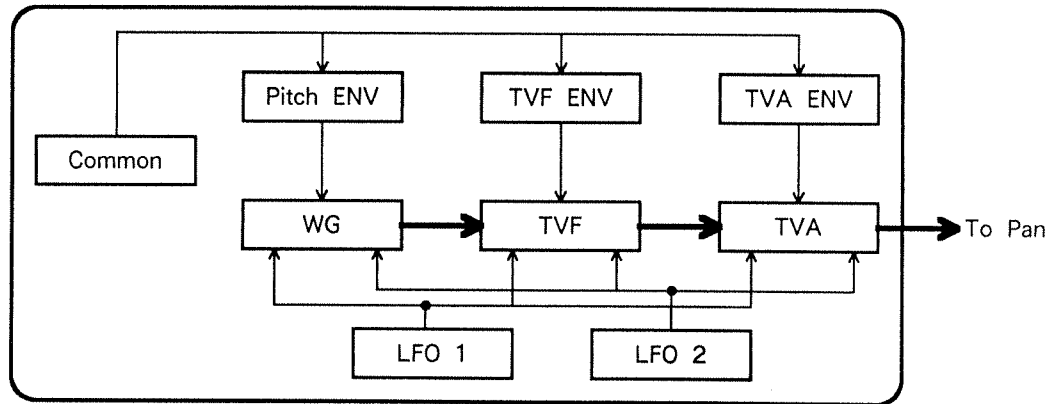

Editing is the same as Tone editing for a Patch. Refer to “Tone edit” (☞ P. I – 4).

| | |
|-----------------------|------------------|
| S.KEY[C2: BassDrum 1] | WG: Pitch coarse |
| Name BassDrum 1 | +00 -- -- -- |

Note

When utilizing the Special Setup’s tone edit, the following functions can be used:

- Original Value
- Active

* You can edit the Tones of individual keys only when in Key Setup (☞ P. II – 15). They cannot be edited while in play mode (i.e., when the Special Part is selected).

* Be aware that the following functions cannot be used while you are Tone Editing a key setup.

- Parameter view (☞ P. I – 7)
- Layer (☞ P. I – 5)

* It is not possible to save the Special Setup for Active On/Off for each key.

2. EDITING IN MULTI MODE

Special Setup edit/Common

○ Common setup

Common parameters apply to the entire setup, and specify Bender Range and Aftertouch Bend Sensitivity.

* If you wish to save you edits, you must use the Setup Write operation (☞ P. II - 29).

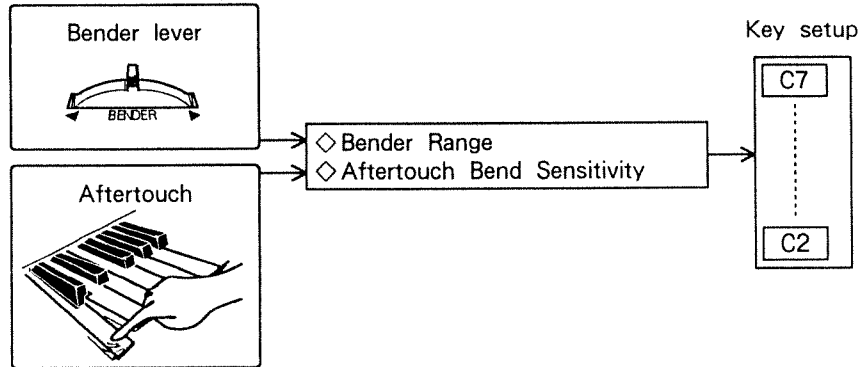

- ① Press **SPECIAL SETUP**.
- ② Press PAGE **▲▼** to select the "COMMON Setup ?" display.

```
SPECIAL COMMON  
Setup ? [Y/N]
```
- ③ Press **INC/YES**.

```
SPECIAL COMMON  
Bender range D:02 U:02
```
- ④ Press PAGE **▲▼** to select a parameter.

```
SPECIAL COMMON  
A-touch bend sens -36
```
- ⑤ Use **VALUE** or **INC/YES** and **DEC/NO** to modify the value.
- ⑥ Repeat steps ④ and ⑤ as necessary.
- ⑦ Press **EXIT** to return to the display of step ②.
- ⑧ Press **EXIT** once again to return to Multi mode.

◇ Bender range

This parameter specifies the bender range. When you move the bender lever, pitch bend will be applied to the entire Special Setup over the range you specify here.

```
SPECIAL COMMON
Bender range D:12 U:02
```

【Values】 [U : 0—12, D : 0—48]

U:0—12 : Specify the amount of upward pitch bend (in chromatic steps, up to 1 octave) that will occur when you move the bender lever toward the right. For a value of 12, the pitch will rise 1 octave when you move the bender lever all the way to the right. Usually you will set this to 02 (a whole step).

D:0—48 : Specify the amount of downward pitch bend (in chromatic steps, up to 4 octaves) that will occur when you move the bender lever toward the left. For a value of 48, the pitch will fall 4 octaves when you move the bender lever all the way to the left. Usually you will set this to 02 (a whole step).

***The pitch will change only for Tones whose Tone parameter Bender Switch (P. I - 34) is ON.**

◇ Aftertouch bend sensitivity

This parameter specifies the amount of pitch bend that will be created by aftertouch. When aftertouch is applied, pitch bend will be applied to the entire Special Setup over the range you specify here.

```
SPECIAL COMMON
A-touch bend sens -36
```

【Values】 [- 36, - 24, - 12—0—+ 12]

For positive (+) values, aftertouch will raise the pitch (maximum rise of 1 octave). For negative (-) values, aftertouch will lower the pitch (maximum fall of 3 octaves). For a value of 0, aftertouch will not affect the pitch.

***The pitch will change only for Tones whose Tone parameter Aftertouch Bend Switch (P. I - 32) is on.**

○ **EQ setup** Here you can make settings for the equalizer that applies to the entire Special Setup.

* If you wish to save the edited data, use the Setup Write operation (☞ P. II - 29).

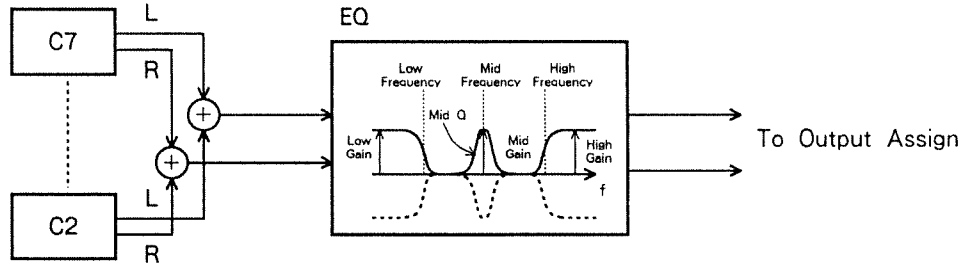

- ① Press **SPECIAL SETUP**.
- ② Press PAGE **▲▼** to select the "EQ Setup ?" display.

```
SPECIAL EQ
Setup ?      [Y/N]
```

- ③ Press **INC/YES**.

```
SPECIAL EQ
Low freq    200Hz
```

- ④ Press PAGE **▲▼** to select a parameter.

```
SPECIAL EQ
Low gain    +10dB
```

- ⑤ Use **VALUE** or **INC/YES** and **DEC/NO** to modify the value.
- ⑥ Repeat steps ④ and ⑤ as necessary.
- ⑦ Press **EXIT** to return to the display of step ②.
- ⑧ Press **EXIT** once again to return to Multi mode.

*Each parameter has the same function as in Patch EQ. Refer to Patch Common "EQ Setup" (P. I - 140).

| | | |
|-----------|---|-----------|
| PAGE ▼ | SPECIAL EQ Low freq 200Hz | PAGE ▲ |
| | SPECIAL EQ Low gain +10dB | |
| | SPECIAL EQ Mid freq 1.25kHz | |
| | SPECIAL EQ Mid Q 4.0 | |
| | SPECIAL EQ Mid gain +03dB | |
| | SPECIAL EQ High freq 8kHz | |
| | SPECIAL EQ High gain +05dB | |

● Functions in Special Setup editing

◇ Special setup write

After editing a Special Setup, if you wish to keep your edits, you must use the Special Setup Write operation to write the data into memory.

* The edited values (the data in the temporary area) will be lost if you do the following.

- If you select a setup from the DATA card
- If you change from Multi mode to Single mode, and then return again to Multi mode
- If you turn the power off and then on again

In order to avoid accidentally losing your edited data, use the Write operation (P. II – 29) to write the data into internal memory (INT) or a DATA card (CRD).

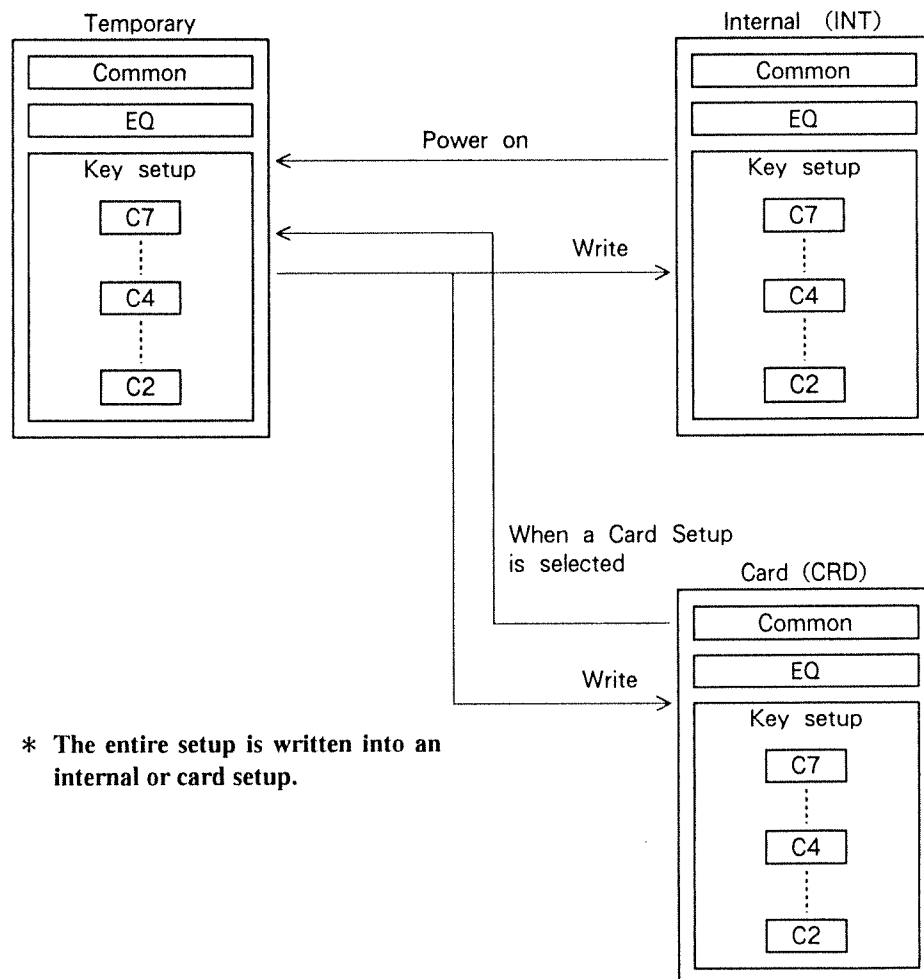

* The entire setup is written into an internal or card setup.

《Special setup write》

This operation stores all setup data (Common, EQ, Key) into internal (INT) or card (CARD) memory. This is valid only while editing a Special Setup (when **SPECIAL SETUP** has been pressed).

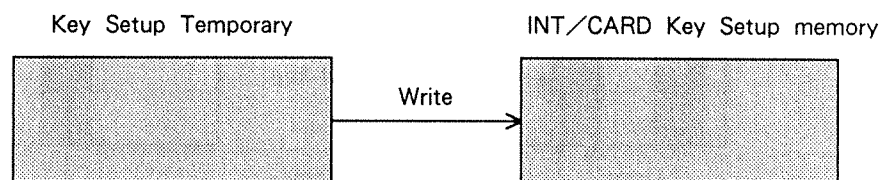

- ① Press **WRITE**.

```

WRITE SPECIAL Setup
to INT ?           [Y/N]
  
```

- ② Press **INT/CARD** to select the writing destination memory area.

```

WRITE SPECIAL Setup
to CRD ?          [Y/N]
  
```

A display of "CRD" indicates the DATA card.

- ③ To store the data, press **INC/YES**.

```

WRITE SPECIAL Setup
to CRD           Completed
  
```

To cancel without storing, press **DEC/NO**.

```

WRITE SPECIAL Setup
to CRD           Canceled
  
```

- ④ You will return to the previous editing display.

2. EDITING IN MULTI MODE

Key setup copy

◇ Key setup copy

This operation copies a specified key setup from memory into the key currently being edited. This is valid only while editing a Key Setup.

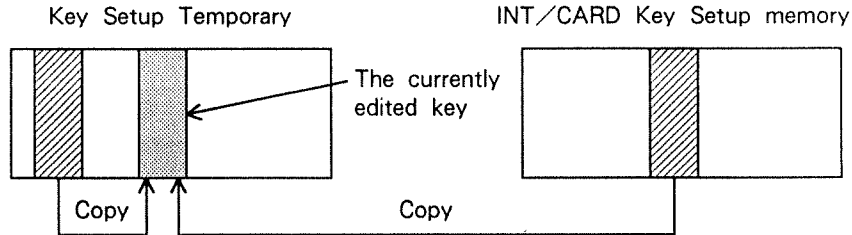

- ① Press **COPY**.

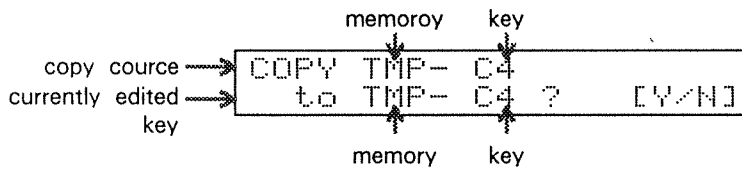

The upper line of the display shows the copy source memory and key, and the lower line shows the currently edited key (the copy destination).

If you wish to copy setting from another key in the temporary area, press the copy source key when the copy source memory display reads "TMP".

- ② Select **INT/CARD** and press the key from which you want to copy the data.

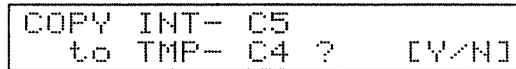

At this time, you can listen to the sound of the copy source.

- ③ To copy the data, press **INC/YES**.

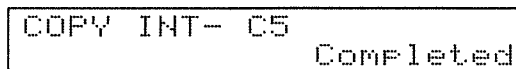

To cancel without copying, press **DEC/NO**.

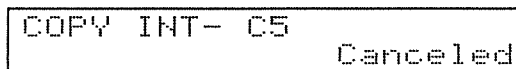

- ④ You will return to the previous editing display.

***If you wish to keep the key setup you copied, you must use the Write operation explained earlier.**

***Patch tone cannot be copied.**

4) Effects edit

In effects edit you can set parameters for the three effect systems used in Multi mode. In Multi mode, the Patch effect settings (the effect settings made for each Patch in Single mode) are ignored.

● How the effects are organized

Multi mode contains the following effects: chorus, delay and reverb. They are divided internally into the following three systems: REV, CHO+REV, and DLY+REV.

The effect that is selected in effect mode, the level of each part, and the sound source will be mixed and output at the MIX OUT jacks.

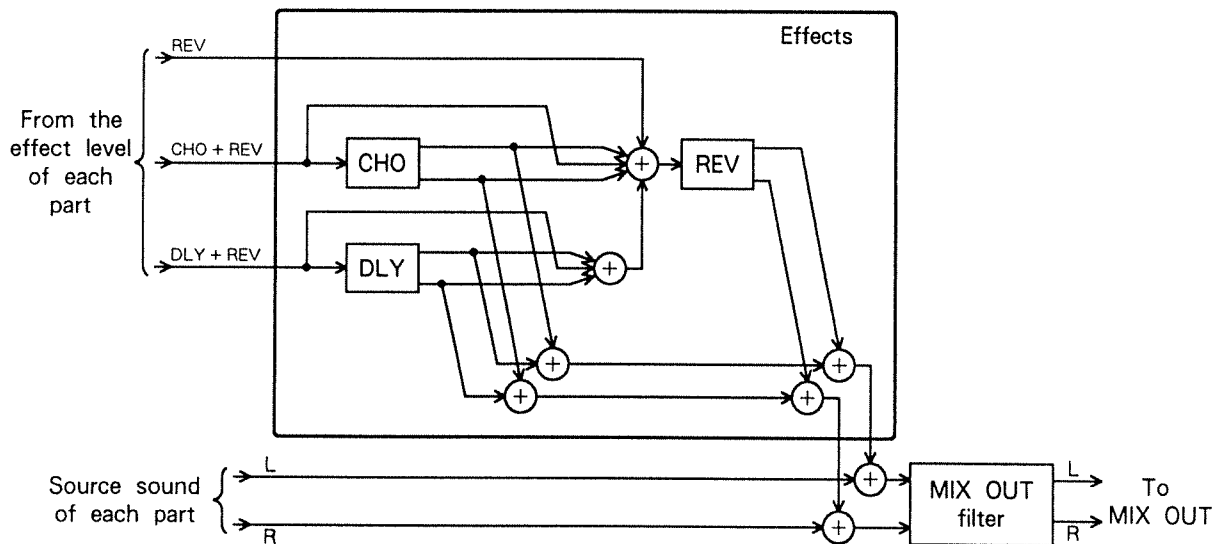

*These settings are preserved in internal memory (INT) even if you do not use the Write operation.

* Program Change Messages will not be received during Effect Edit.

* The effect which is set to "off" by the Effect Master switch (☐ P. III - 9), cannot be used.

Note

If you want to apply only chorus or only reverb to a part, select "CHO+REV" or "DLY+REV" in the part's effect mode and turn down the reverb level. However, if the effect mode of another part is set to "REV", reverb will not be heard.

○ Chorus setup

The various parameters are the same as for Chorus in Patch Effect.
Refer to Single mode "Chorus Setup" (P. I - 104).

- ① Press **EFFECTS**.
- ② Press PAGE **▲▼** to select the "Chorus Setup ?" display.

```
EFFECTS Chorus  
Setup ?      [Y/N]
```

- ③ Press **INC/YES**.

- ④ Press PAGE **▲▼** to select a parameter.

```
↑  
EFFECTS Chorus  
Rate          2.5Hz  
-----  
EFFECTS Chorus  
Depth         80  
-----  
▼ EFFECTS Chorus  
Delay         20ms  
-----  
EFFECTS Chorus  
Feedback      +50%  
-----  
EFFECTS Chorus  
Level         100  
↓
```

- ⑤ Use **VALUE** or **INC/YES** and **DEC/NO** to specify the value.
- ⑥ Repeat steps ④ and ⑤ as necessary.
- ⑦ Press **EXIT** to return to the display of ②.
- ⑧ Press **EXIT** once again, and you will return to Multi mode.

- **Delay setup** The various parameters are the same as for Delay in Patch Effect.
Refer to Single mode “Delay Setup” (P. I – 107).

- ① Press **EFFECTS**.
- ② Press PAGE **▲▼** to select the “Delay Setup ?” display.

```

EFFECTS Delay
Setup ?           [Y/N]
  
```

- ③ Press **INC/YES**.
- ④ Press PAGE **▲▼** to select a parameter.

```

↑
EFFECTS Delay
Center tap      400ms
EFFECTS Delay
Center level    50
EFFECTS Delay
Left tap        200ms
▼ EFFECTS Delay
Left level      50 ▲
EFFECTS Delay
Right tap       400ms
EFFECTS Delay
Right level     50
EFFECTS Delay
Feedback        -50%
↓
  
```

- ⑤ Use **VALUE** or **INC/YES** and **DEC/NO** to specify the value.
- ⑥ Repeat steps ④ and ⑤ as necessary.
- ⑦ Press **EXIT** to return to the display of ②.
- ⑧ Press **EXIT** once again, and you will return to Multi mode.

○ Reverb setup

The various parameters are the same as for Reverb in Patch Effect.

For details of each parameter, refer to “Reverb Setup (in Signal mode)” (P. I – 112).

- ① Press **EFFECTS**.
- ② Press PAGE **▲** **▼** to select the “Reverb Setup ?” display.

```

EFFECTS Reverb
Setup ?           [Y/N]
  
```

- ③ Press **INC/YES**.
- ④ Press PAGE **▲** **▼** to select a parameter.

| | | | |
|---|-----------------------------------|-------|---|
| ▲ | EFFECTS Reverb Type | HALL1 | |
| | EFFECTS Reverb Pre delay time | 100ms | |
| | EFFECTS Reverb Early ref level | 80 | |
| ▼ | EFFECTS Reverb HF damp | 5kHz | ▲ |
| | EFFECTS Reverb Time | 3.5s | |
| | EFFECTS Reverb Level | 50 | ▼ |

- ⑤ Use **VALUE** or **INC/YES** and **DEC/NO** to specify the value.
- ⑥ Repeat steps ④ and ⑤ as necessary.
- ⑦ Press **EXIT** to return to the display of ②.
- ⑧ Press **EXIT** once again, and you will return to Multi mode.

System Settings

Here you can make settings affecting the entire JD-800 (Single mode and Multi mode) that are not affected by the selected Patch or Part settings.

1. HOW THE SYSTEM PARAMETERS ARE ORGANIZED

The System parameters are organized as follows. Press **TUNE/FUNC** or **MIDI**, and make the desired settings.

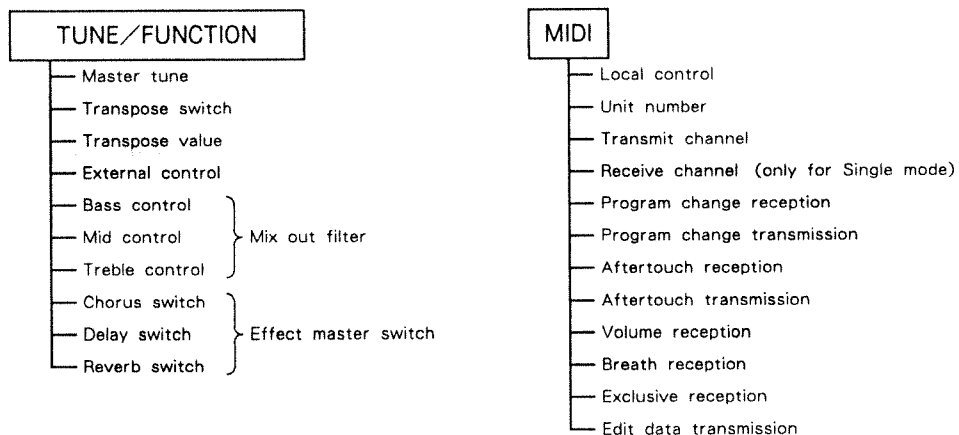

2. TUNE / FUNCTION

Here you can make settings for tuning, transpose, etc.

With certain exceptions, the procedure is the same for each parameter. Individual explanations will be given for the exceptions.

***The settings you make here are retained even when the power is turned off. There is no need to write them into memory.**

- ① Press **TUNE/FUNC**.
- ② Press PAGE **▲▼** to select the desired parameter display.
- ③ Use **VALUE** or **INC/YES** and **DEC/NO** to modify the value.
- ④ Repeat steps ② and ③ as necessary.
- ⑤ Press **EXIT** to return to play mode.

● Master tune

This value specifies the tuning of the entire JD-800, with the pitch of the A4 key as the reference.

```
TUNE/FUNCTION
Master tune    440.0Hz
```

【Values】 [427.5 Hz—452.9 Hz]

The pitch can be adjusted in 1 cent steps over a range of 427.5 Hz to 452.9 Hz, for a pitch adjustment of ± 50 cents. This is displayed as a frequency (Hz).

*** With the factory setting, A4 will be set to 440.0 Hz.**

Note

One cent is 1/100 of a chromatic step. Thus, the number of Hz (hertz) in one cent will depend on the pitch. Since the basic unit of musical pitch is the octave, it is usually convenient to set pitch values in cents. In the JD-800, the display will indicate Hz, but the actual pitch will change in cents.

● Transpose switch

The Transpose function allows you to shift the pitch of the entire keyboard. This parameter determines whether the Transpose setting will be applied or not.

Normally the JD-800 keyboard covers the range C2—C7. However, if the Transpose Value (explained on the following page) is set to a value of -12 (for example), the keyboard will cover the range C1—C6, which is 1 octave lower.

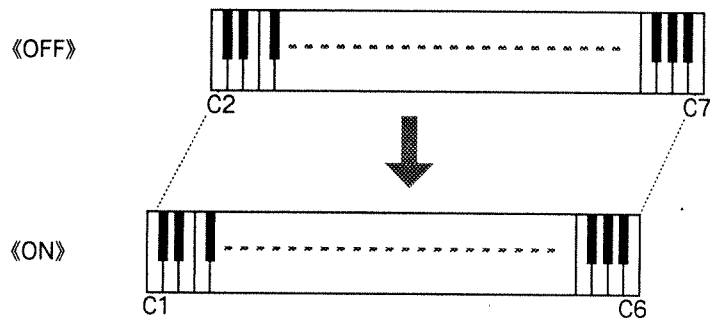

① Press **TRANPOSE** (the indicator will light).

【Values】 [ON, OFF]

ON : Transpose will be applied.

OFF : Transpose will not be applied.

* This value will not appear in the display. It is indicated by the **TRANPOSE** indicator.

* If you transpose while in Multi mode when you have selected the Special Part, keys other than C2—C7 will produce no sound.

* MIDI Note messages will be transmitted from MIDI OUT with the note number specified by the Transpose function.

Application ideas Pianos normally have 88 (or 73 keys), but the JD-800 has only 61. When playing sounds (such as piano) for which you want more keys, this function allows you to raise or lower the keyboard an octave as you play.
Or if you need to change keys in the middle of a song, you can set the appropriate transposition beforehand, and then continue playing without having to alter your fingering.

● Transpose value

This parameter specifies how the keyboard pitch is shifted when Transpose is applied.

| | |
|---------------|-----|
| TUNE/FUNCTION | |
| Transpose | -12 |

【Values】 [- 12 — + 12]

+12 : The keyboard pitch will be raised 1 octave, to cover the range C3—C8.

0 : Transpose will not be applied. The keyboard pitch will cover the range C2—C7.

- 12 : The keyboard pitch will be lowered 1 octave, to cover the range C1—C6.

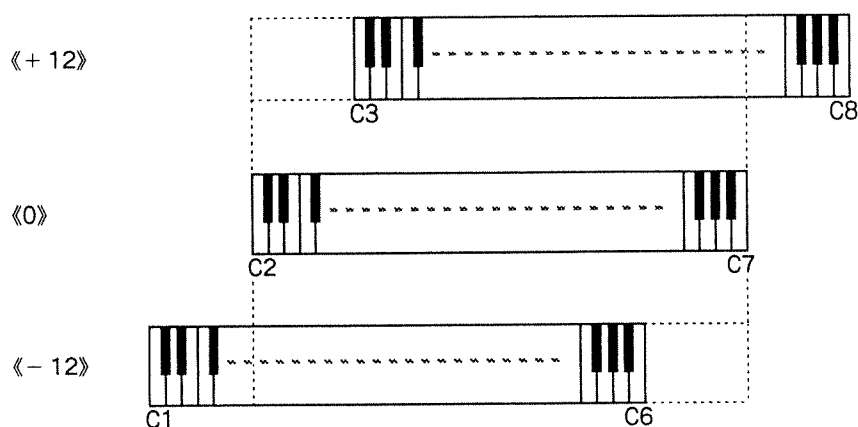

* When playing the Special Part in Multi mode, only keys C2—C7 will sound. This means that if you set the Transpose Value to +12 or - 12 and turn the Transpose switch On, the top or bottom octave will not sound.

● External control

This setting determines what function will be controlled by a pedal (EV-5, EV-10; sold separately) connected to the EXT CONT jack.

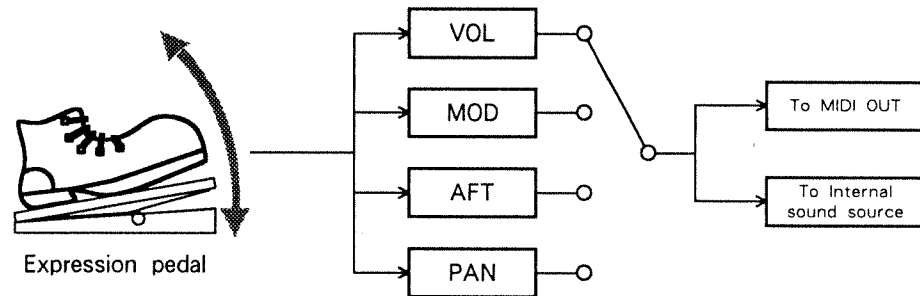

```
TUNE/FUNCTION
Ext control      VOL
```

For the selected parameter, the pedal will control the internal sound source, and will also transmit MIDI messages to control external devices.

【Values】 [VOL, MOD, PAN, AFT]

- VOL : The pedal will control Volume.
- MOD : The pedal will control Modulation.
- PAN : The pedal will control Pan.
- AFT : The pedal will control Aftertouch.

With these values, the pedal will control the internal sound source in the following ways.

| | Single mode | Multi mode |
|-----|-------------------------|--------------------|
| VOL | MIDI volume(☞P. I - 88) | Part level |
| MOD | vibrato depth | vibrato depth |
| PAN | no effect | Part pan |
| AFT | same as Aftertouch | same as Aftertouch |

* For details on the MIDI messages that are transmitted, refer to MIDI implementation (☞P. V - 53).

* When "AFT" has been set, the aftertouch message from the key will not affect by the internal sound source, and it will not be transmitted from MIDI OUT.

2. TUNE / FUNCTION

Mix out filter

- Bass control
 - Mid control
 - Treble control
- } (MIX OUT filter)

These parameters allow you to make compensations for the frequency response of your amplification system (stereo, amp, etc.).

These parameters adjust (boost or cut) the low (Bass: around 400 Hz), middle (Mid: around 1 kHz), and high (Treble: around 4 kHz) frequency bands of the sound that is output from the MIX OUT jacks.

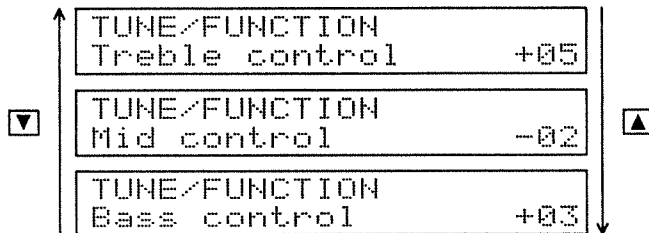

【Values】 [- 5 - + 5]

For negative (-) values, the frequency band will be cut. For positive (+) values, the frequency band will be boosted. If it is set to 0, the special status of the frequency will be flat.

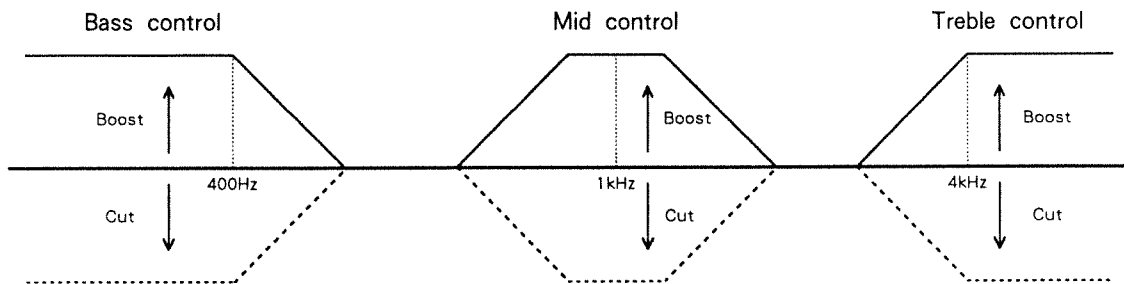

*** These settings have no effect on the sound from the DIRECT OUT jacks.**

Application ideas

These three parameters are used in a different way than the equalizer that is included in each Patch. These parameters are used only for the purpose of compensating for the frequency response of your external amplification system. If you use these three parameters in order to create the sound of a Patch, other Patches will also be affected.

- Chorus switch
 - Delay switch
 - Reverb switch
- } (Effect master switch)

This switch determines whether or not you are using the internal effects (Chorus/Delay/Reverb). The setting will be common to both Single and Multi modes.

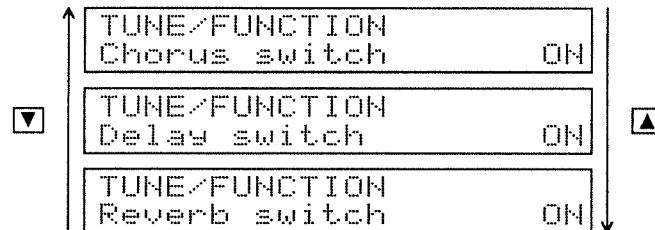

【Values】 [ON, OFF]

- ON : Internal effects will work
- OFF : Internal effects will not work

In Single mode, you can turn the effects of all patches on/off regardless of the setting of effect group B.

In Multi mode, you can turn the effects of all parts on/off regardless of the setting of Part Output assign.

Application ideas It is possible to turn the internal effects off and use only an external effect device. Also, if you are playing in a room that has a lot of natural reverb, turning off the Reverb and Chorus effects will result in a clearer sound.
If you want to hear the original unprocessed patch sound, leave all effect switches off.

3. MIDI

This section explains the various parameters you will set when connecting external MIDI devices to the JD-800. With the exception of some parameters, the values you set here are stored directly in internal memory.

- ① Press **MIDI**.
- ② Press the PAGE **▲** **▼** keys to select the parameter you wish to set.
- ③ Use **VALUE** or the **INC/YES** and **DEC/NO** keys to modify the blinking value.
- ④ Repeat steps ② and ③ as necessary.
- ⑤ To return to the Play display, press **EXIT**.

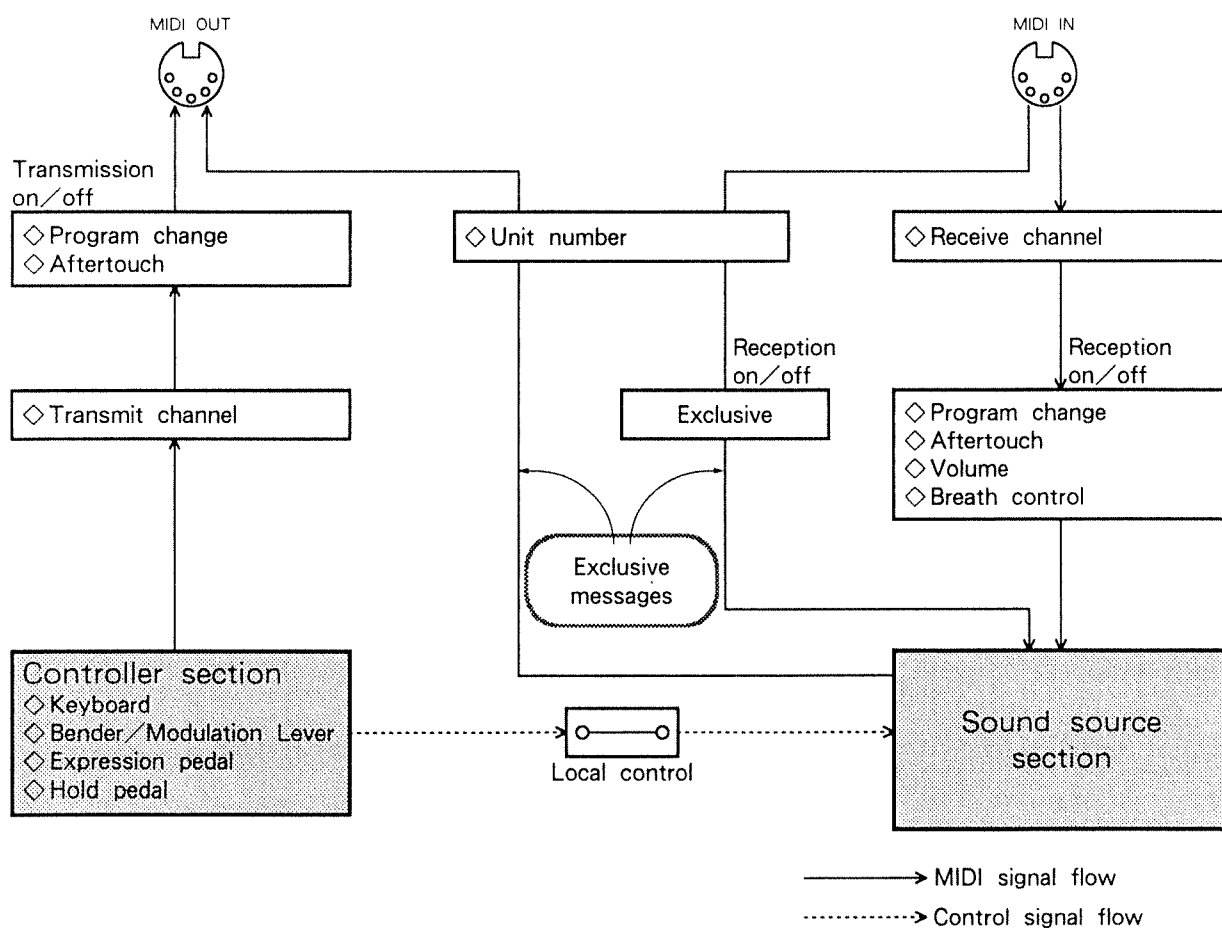

● Local control

Turn local control on/off to specify whether or not the controller section (keyboard, bender, etc.) will be connected to the internal sound source. Normally this will be on, so that the keyboard will play the internal sound source. If this is set off, the keyboard will not play the internal sound source, but will only transmit MIDI messages from MIDI OUT.

```
MIDI
Local control      ON
```

【Values】 [ON, OFF]

ON : The controller section will be connected to the internal sound source.

OFF : The controller section will not be connected to the internal sound source.

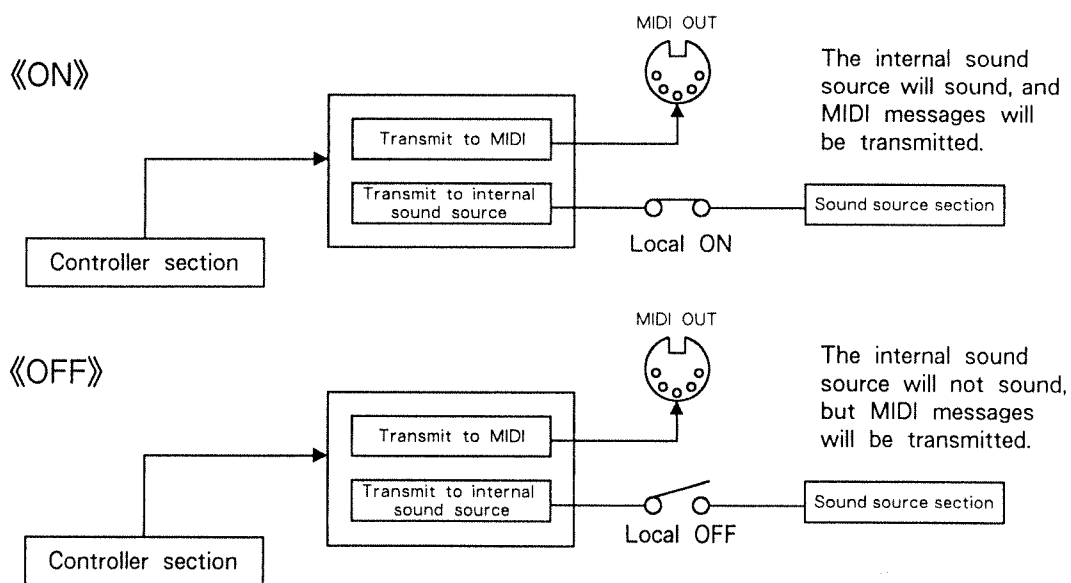

* When the power is turned on, this will automatically be set to Local On.

* If MIDI devices are not connected, there will be no sound if this is off.

Application ideas When using the JD-800 as a master keyboard, you can set Local Off so that only the external MIDI sound sources will sound. When recording on a sequencer you should also set Local Off and set the sequencer to Soft Thru on.

● Unit number

Specify the unit number.

| | |
|---------------------|----|
| MIDI Unit number | 17 |
|---------------------|----|

Unlike MIDI Note messages, etc. MIDI Exclusive messages do not require a “channel”, since they are unique to a specific device. For this reason, MIDI Exclusive messages for Roland equipment include an identifying Unit Number.

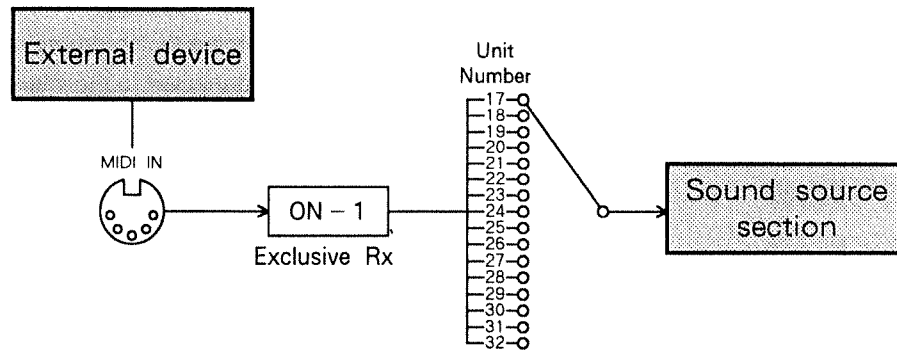

【Values】 [17—32]

Select one of the sixteen unit numbers from 17 to 32.

*** When the power is turned on, this will automatically be set to 17.**

*** Be aware how this is related to Exclusive message reception (☞ P. III - 23).**

Application ideas When controlling two or more JD-800's from a sequencer, you can set each unit to a different unit number and transmit independent data to each unit.

● Transmit channel

Specify how the JD-800 will transmit MIDI messages.

| | |
|--------------------|-------|
| MIDI Tx channel | RX CH |
|--------------------|-------|

* The value that you set here will be stored even after the power is turned off.

【Values】 [1—16, RX CH (PART), PATCH, OFF]

1—16 : The transmit channel will be fixed.

RX CH : This will appear only in Single mode. The transmit channel will be the same as the receive channel (☞ P. III - 15).

(PART) : This will appear only in Multi mode. The transmit channel will be the same as the receive channel of the Part (☞ P. II - 8).

PATCH : The transmit channel will be the same as the Patch Common MIDI transmit channel (☞ P. I - 135).

OFF : MIDI messages will not be transmitted.

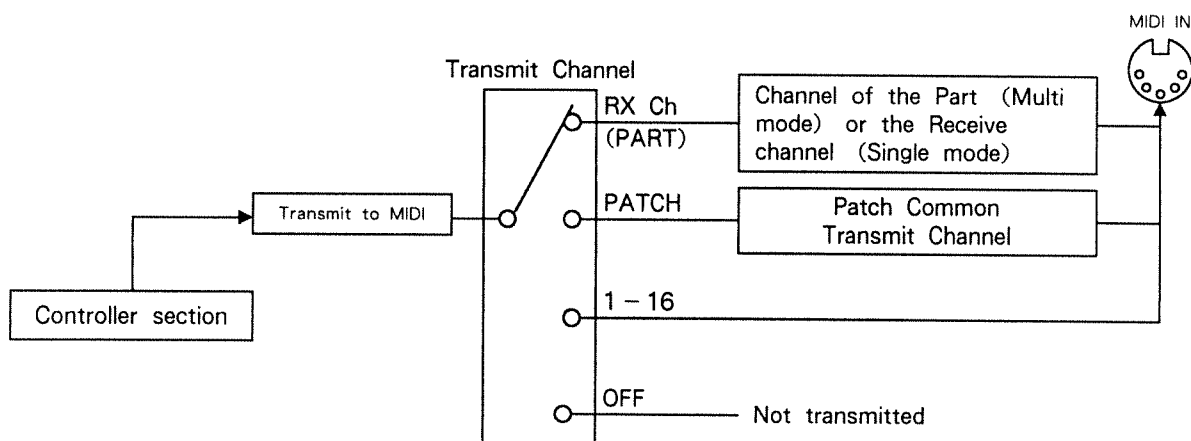

* If this is set to “RX CH (PART)”, and the Rx Ch (☞ P. III - 15, II - 8) setting is “OFF”, then MIDI messages will not be transmitted.

3. MIDI

Transmit channel

Application ideas ◇RX CH (or PART)

Normally you will set this to "RX CH (or PART)".

With this setting, the transmit and receive channels will be the same, allowing you to avoid confusion when recording to a sequencer, etc.

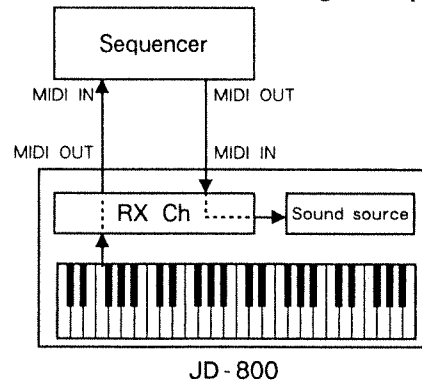

◇PATCH

MIDI messages will be transmitted on the upper/lower transmit channels specified for the Patch "MIDI Tx". In this case, the transmit channel will be completely independent of the receive channel, which can be convenient when using the JD-800 as a master keyboard to control two or more external sound sources.

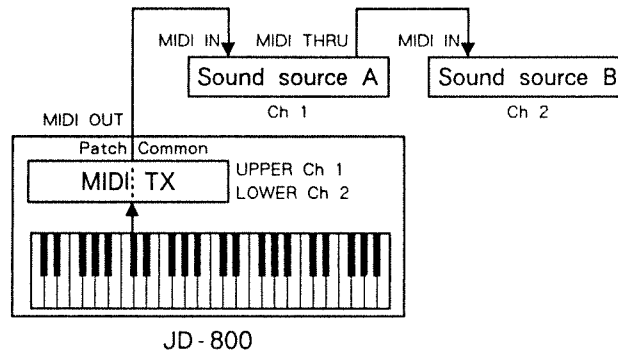

◇1—16

MIDI messages will always be transmitted on the specified channel.

◇OFF

MIDI messages will not be transmitted. This is convenient when you want to control only the internal sound source and when you don't want to send MIDI messages for the moment.

● Receive channel (Single mode only)

This specifies the MIDI channel on which MIDI messages from an external device will be received. This setting is only for Single mode.

| | |
|--------------------|----|
| MIDI Rx channel | 01 |
|--------------------|----|

【Values】 [1 — 16, OFF]

1 — 16 : MIDI messages will be received on the specified channel.

OFF : MIDI messages will not be received.

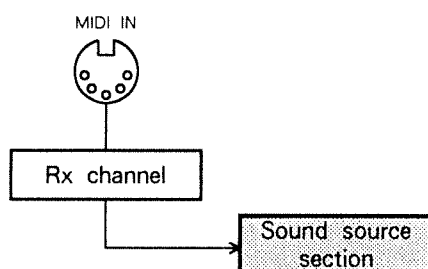

* The receive channel in Multi mode is specified by the “MIDI receive channel” (P. II – 8) in the Part.

* This setting is retained even when the power is turned off.

3. MIDI

Program change transmission

● Program change transmission

This specifies how program changes will be transmitted when you press **INT/CARD**, BANK **1—8**, and NUMBER **1—8**.

```
MIDI  
Tx Program chg  NORMAL
```

*** This setting is retained even when the power is turned off.**

【Values】 [OFF, NORMAL, PATCH]

OFF : Program changes will not be transmitted.

NORMAL : The program change number specified for the Bank/Number will be transmitted.

PATCH : The program change number specified for the Patch "MIDI Tx" will be transmitted.

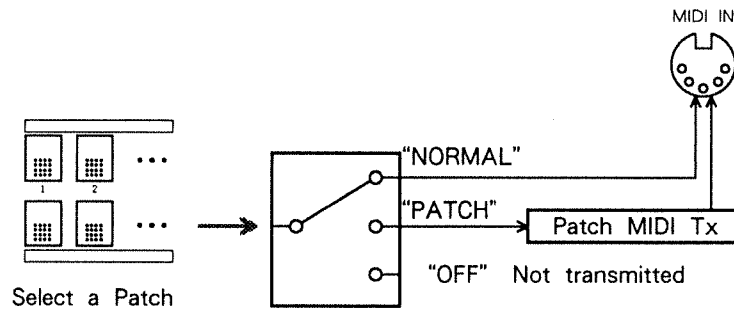

*** In the Special Part of Multi mode, press **INT/CARD**, and Program Change numbers 001 and 002 will be transmitted alternately.**

Application ideas ◇NORMAL

You will usually leave this set to NORMAL. With this setting, the same program numbers will be received and transmitted, avoiding confusion when recording to a sequencer.

How Patch numbers correspond with Program Change numbers

| (INT) | | BANK | | | | | | | | (CARD) | | BANK | | | | | | | |
|--------|---|------|----|----|----|----|----|----|----|--------|---|------|-----|-----|-----|-----|-----|-----|-----|
| | | 1 | 2 | 3 | 4 | 5 | 6 | 7 | 8 | | | 1 | 2 | 3 | 4 | 5 | 6 | 7 | 8 |
| NUMBER | 1 | 1 | 2 | 3 | 4 | 5 | 6 | 7 | 8 | NUMBER | 1 | 65 | 66 | 67 | 68 | 69 | 70 | 71 | 72 |
| | 2 | 9 | 10 | 11 | 12 | 13 | 14 | 15 | 16 | | 2 | 73 | 74 | 75 | 76 | 77 | 78 | 79 | 80 |
| | 3 | 17 | 18 | 19 | 20 | 21 | 22 | 23 | 24 | | 3 | 81 | 82 | 83 | 84 | 85 | 86 | 87 | 88 |
| | 4 | 25 | 26 | 27 | 28 | 29 | 30 | 31 | 32 | | 4 | 89 | 90 | 91 | 92 | 93 | 94 | 95 | 96 |
| | 5 | 33 | 34 | 35 | 36 | 37 | 38 | 39 | 40 | | 5 | 97 | 98 | 99 | 100 | 101 | 102 | 103 | 104 |
| | 6 | 42 | 42 | 43 | 44 | 45 | 46 | 47 | 48 | | 6 | 105 | 106 | 107 | 108 | 109 | 110 | 111 | 112 |
| | 7 | 49 | 50 | 51 | 52 | 53 | 54 | 55 | 56 | | 7 | 113 | 114 | 115 | 116 | 117 | 118 | 119 | 120 |
| | 8 | 57 | 58 | 59 | 60 | 61 | 62 | 63 | 64 | | 8 | 121 | 122 | 123 | 124 | 125 | 126 | 127 | 128 |

◇PATCH

If set the Transmit channel to "PATCH", the upper/lower program change numbers specified for the Patch "MIDI Tx" will be transmitted on the respective transmit channels. This is convenient when using the JD-800 as a master keyboard to control two or more external sound sources.

For example,

Keyboard : SPLIT
 Channel : L: 02, U: 01
 Program Change Number : L: 002, U: 032

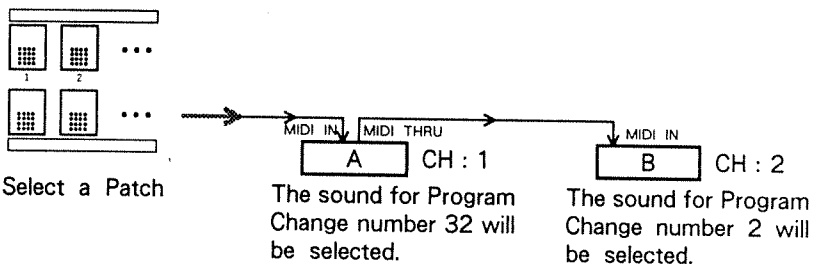

* When the transmit channel is set to 1—16 or Rx channel, only the upper program change number will be transmitted.

◇OFF

Program changes will not be transmitted. This is effective for changing the internal patch without changing the sound of the external sound source.

● Program change reception

This specifies whether program change messages from an external MIDI device will be received or not. When a Program Change message is received, the Patch or Setup will change.

```
MIDI
Rx Program change  ON
```

When controlling the JD-800 from a master keyboard etc., turn this on. When off, Patches will not change.

*** This setting is retained even when the power is turned off.**

【Values】 [ON, OFF]

ON : When a program change message is received from an external MIDI device, the Patch will change.

OFF : Program change messages from an external MIDI device will not be received. Incoming program change messages will not select Patches.

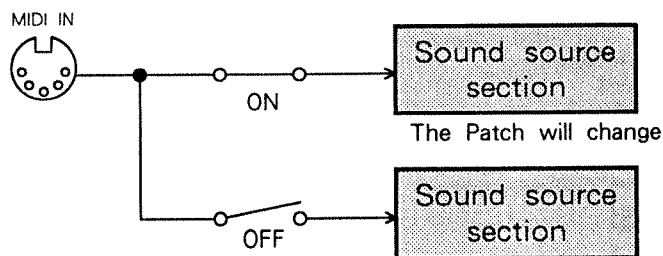

*** For information concerning the correspondence between program change numbers and patches, refer to “How Patch Numbers Correspond with Program Change Numbers” (previous page).**

● Aftertouch transmission

This specifies whether or not the JD-800's keyboard will transmit aftertouch messages (channel aftertouch only) to external MIDI devices.

```
MIDI
Tx A-touch          ON
```

*** This setting is retained even when the power is turned off.**

【Values】 [ON, OFF]

ON : Aftertouch messages will be transmitted.

OFF : Aftertouch messages will not be transmitted.

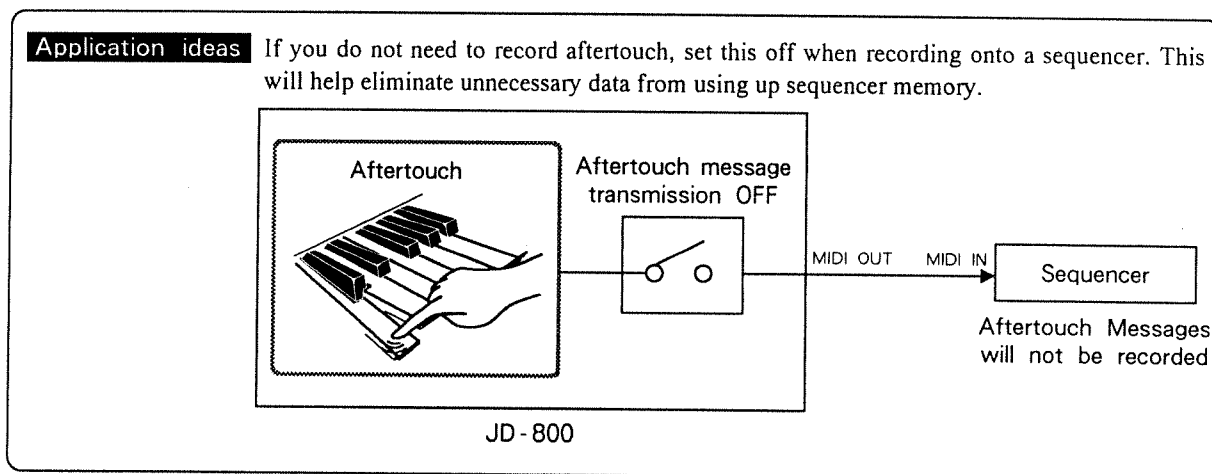

● Aftertouch reception

This specifies whether or not aftertouch messages (channel aftertouch only) will be received from external MIDI devices.

| | |
|-------------------|----|
| MIDI Rx Atouch | ON |
|-------------------|----|

If this is turned on, incoming aftertouch messages will affect the following Tone parameters.

- Pitch Aftertouch Bend (☞ P. I - 32)
- Pitch Aftertouch Modulation (☞ P. I - 39)
- Cutoff Aftertouch (☞ P. I - 59)
- Level Aftertouch (☞ P. I - 72)

*** This setting is retained even when the power is turned off.**

【Values】 [ON, OFF]

- ON : Incoming aftertouch messages will affect the Patch.
- OFF : Incoming aftertouch messages will be ignored.

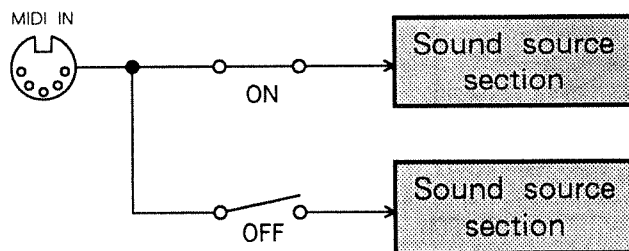

*** Even if this is set to Off, the JD-800 keyboard or external pedal will be able to apply aftertouch to the internal sound source.**

*** Only channel aftertouch messages (Dn) are received and transmitted. Polyphonic aftertouch messages (An) cannot be received or transmitted.**

● Volume reception

This specifies whether or not volume messages will be received from external MIDI devices. If a Volume message is received when this is ON, in Single mode the MIDI volume (refer to the diagram on P. I – 88) will change, and in Multi mode the Part level will change.

| | |
|-------------------|----|
| MIDI Rx volume | ON |
|-------------------|----|

* This setting is retained even when the power is turned off.

【Values】 [ON, OFF]

ON : Incoming volume messages will affect the Patch (Part) volume.

OFF : Incoming volume messages will be ignored.

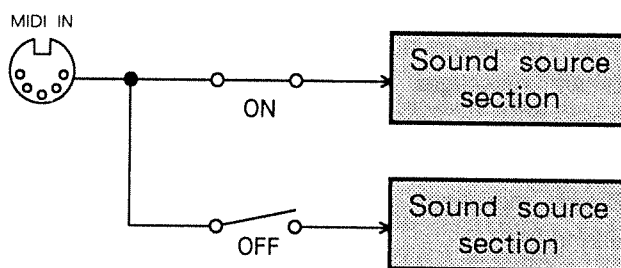

* If a volume message of 0 is received when this is turned on, there will be no sound. In this case, take one of the following steps.

- ◇ Transmit a volume message with a higher value from the external device.
- ◇ Set the EXT CONT setting to VOL, and raise the volume value (⇨ P. III – 7).
- ◇ Switch between Single mode ↔ Multi mode.
- ◇ Turn the power off and then on again.

Application ideas If EXT CONT has been set to VOL, you can use the pedal to adjust the volume. In Multi mode, the Part level shown in the display allows you to check the volume value (⇨ P. II – 9).

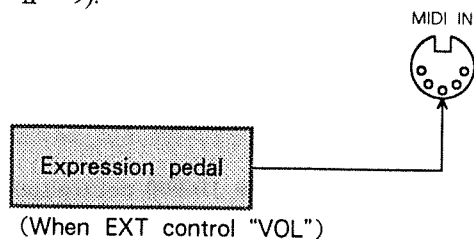

● Breath reception

This specifies how breath messages are received.

This parameter determines how incoming Breath Control messages (from a wind controller, etc.) will affect the JD-800.

| | |
|-------------------|-----|
| MIDI Rx breath | VOL |
|-------------------|-----|

*** This setting is retained even when the power is turned off.**

[Values] [OFF, VOL, MOD, AFT, V & M, V & A, M & A, ALL]

OFF : Breath messages will not be received.

VOL : Breath messages will control the volume.

MOD : Breath messages will control modulation (vibrato).

AFT : Breath messages will control aftertouch.

V&M : Breath messages will simultaneously control volume and modulation (vibrato).

V&A : Breath messages will simultaneously control volume and aftertouch.

M&A : Breath messages will simultaneously control modulation (vibrato) and aftertouch.

ALL : Breath messages will simultaneously control volume, modulation (vibrato) and aftertouch.

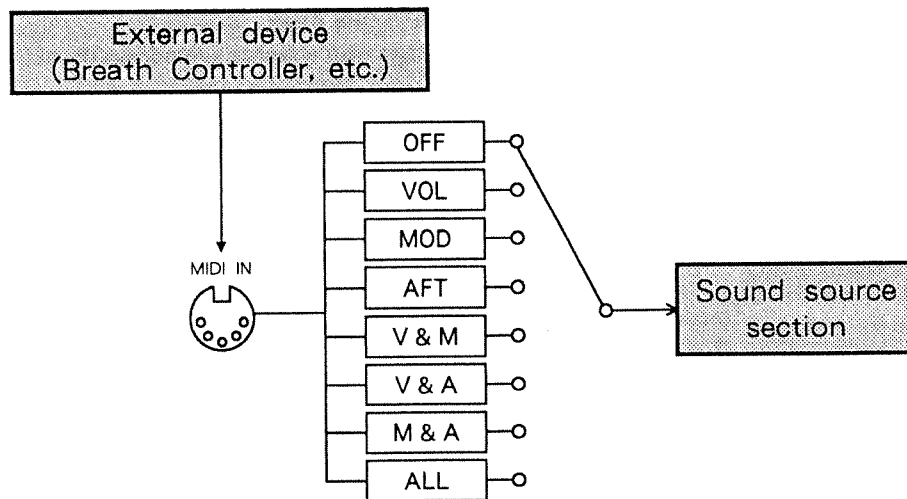

*** Breath messages can only be received by the JD-800, not transmitted.**

● Exclusive reception

This specifies how Exclusive messages from an external device will be received. Exclusive messages can be received in the normal play status except during Data transfer or ROM play. This setting determines how the JD-800 will receive an Exclusive message that has been transmitted from an external device.

```
MIDI
Rx exclusive      ON-1
```

* This setting is retained even when the power is turned off.

[Values] [OFF, ON-1, ON-2]

OFF : Exclusive messages will not be received.

ON-1 : Exclusive messages will be received only if they have the same unit number as the JD-800.

ON-2 : All Exclusive messages will be received regardless of the unit number.

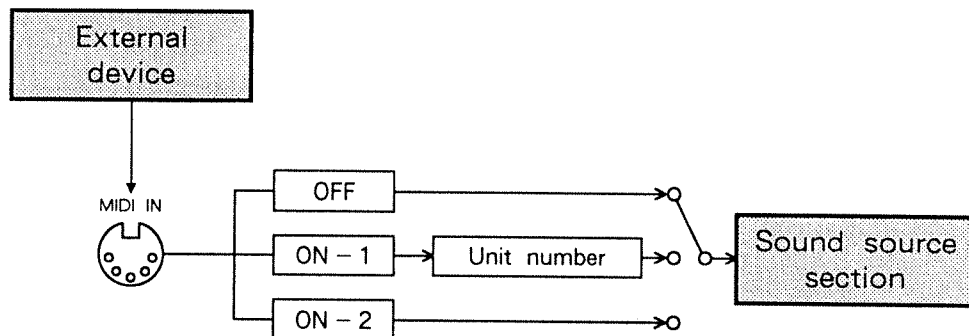

Application ideas There are three ways to transmit Exclusive messages from the JD-800.

- ◇ Patch Dump (transmit the data for a single patch. ⇨ P. IV - 10)
- ◇ Bulk Dump (transmit all internal data: ⇨ P. IV - 12)
- ◇ Edit Data Transmission (⇨ next page)

* For transmission procedure, refer to "Data Transfer".

* For details of data transmission and reception, refer to "Exclusive Communications" (⇨ P. V - 58).

● Edit data transmission

This determines whether or not your tone editing changes of Patch or Special Setup (using front panel sliders and switches) will be transmitted as Exclusive messages.

| | |
|----------------------|-----|
| MIDI Tx edit data | OFF |
|----------------------|-----|

* Data will be transmitted only for Tones which are Active ON. If all Tones are set to Active OFF, you can transmit data by operating the Palette sliders.

【Values】 [OFF, ON]

OFF : Parameter messages will not be transmitted.

ON : Parameter messages will be transmitted.

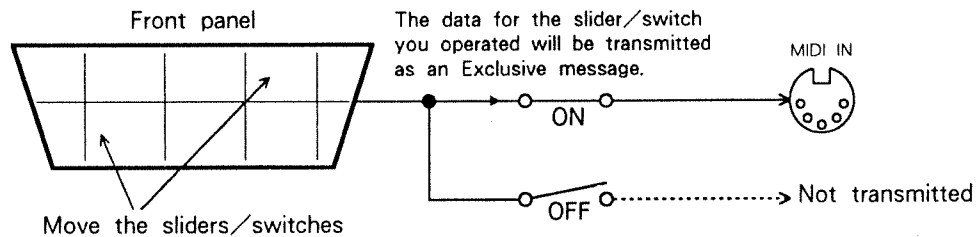

* When the power is turned on, this will automatically be set to Off.

* This will increase the amount of data that is transmitted, so notes may be delayed when this data is received. It is also best to avoid moving two or more sliders simultaneously.

* For details of the Exclusive messages that are transmitted, refer to “Exclusive Communications” (P. V – 58).

Application ideas For example when realtime recording with the JD-800 connected to a sequencer, you can move a slider to record the movements of that slider as Exclusive messages. When the sequencer is played back, the sound will change in the same way as it did while you were recording.

Data Transfer

Data transfer is the process of exchanging data (patch data, exclusive messages, etc.) between devices. Data transfer is used to store patch or setup data to a data card. It is also used for storing internal data to an external MIDI device.

- * Data transfer can be operated while playing (or moving a slider on the panel).It cannot be operated while editing or while performing the write function.
- * During data transfer, exclusive messages can be transmitted but not received. It is impossible to receive or transmit any other type of MIDI message.

1. Card initialize

● Card initialize

New data cards (M-256E) and data cards that you have used in other devices must first be initialized before they can be used with the JD-800.

This procedure is for transferring the initialize data, stored in the internal initialize memory, to card memory.

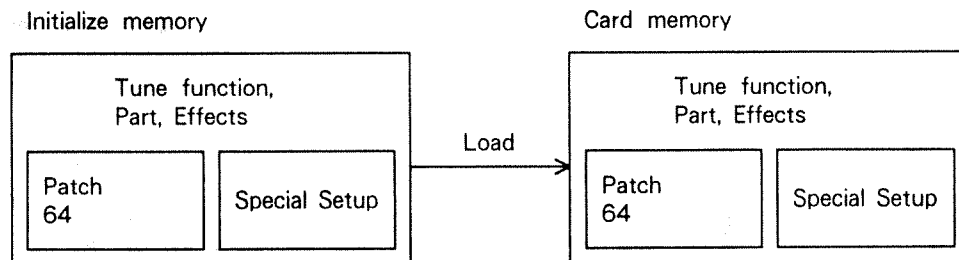

* When this procedure is executed, all the patch data (C-11 — C-88) will be the same.

【Connection】

Insert the DATA card into the DATA slot. Turn the protect switch on the DATA card off.

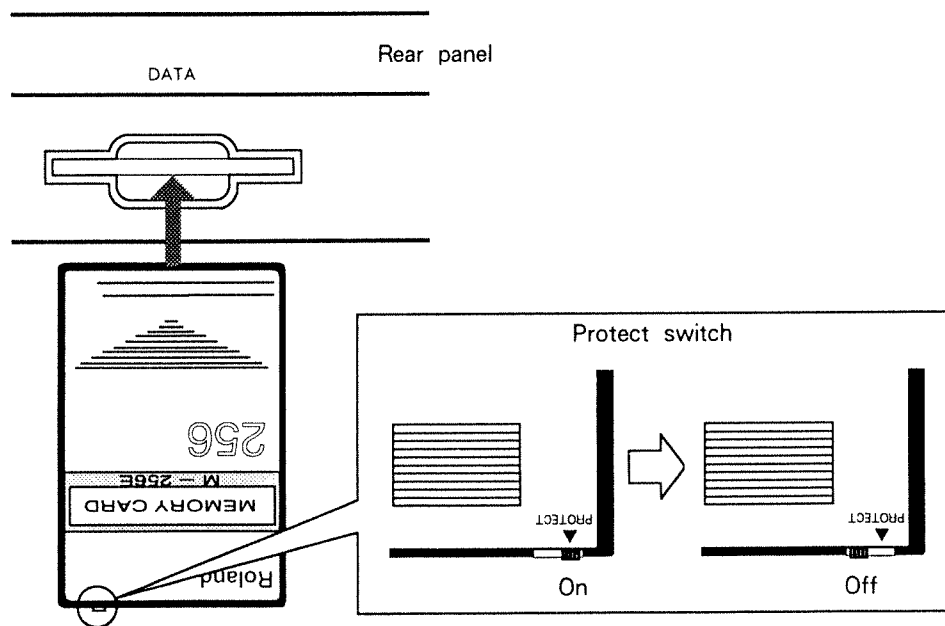

* When you use a new DATA card, please refer to the owner's manual of the card for setting instructions. Please do not attempt to execute this procedure until the included battery (CR 2016) has been installed in the DATA card.

① Press **DATA TRANSFER**.

② Press PAGE **▲▼** to call the following screen.

```
DATA card initialize
                ? [Y/N]
```

③ Press **INC/YES** to begin the transfer.

```
DATA card initialize
                Completed
```

To cancel the operation, press **DEC/NO**.

```
DATA card initialize
                Canceled
```

④ The display will then return to the previous play screen.

*** If the DATA card's protect switch is on, the following display will appear briefly after the execution of step ③.**

```
DATA card is Protected
```

Turn the DATA card's protect switch off to continue the operation.

*** Be sure to use only the M-256E DATA card (sold separately).**

Note

Initialized data is set to the proper status to create sound from the beginning. To create your own original sound, select the card patch number and begin editing after executing card initialize.

2. DATA TRANSFER WITH A CARD

● Card save

This operation saves data from the internal memory to a DATA card.

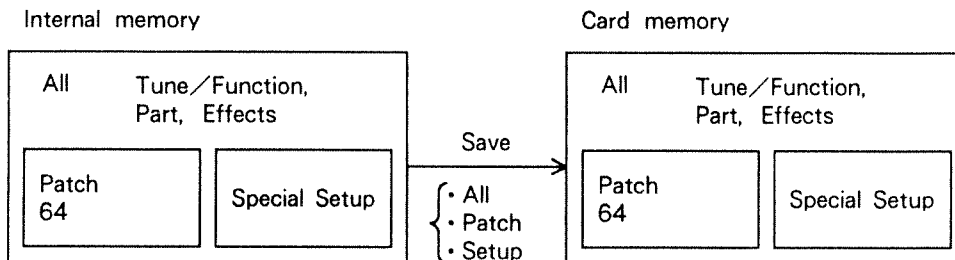

This procedure is for saving the internal data to a DATA card beforehand in case of accidental erasure or internal memory breakdown.

【Data types】 [All, Patch, Setup]

All : All data for System (Tune/Function, Part, Effects), the 64 Patches (I-11 — I-88), and the Special Setup will be saved.

Patch : The data for the 64 Patches will be saved.

Setup : The data for the Special Setup will be saved.

【Preparations】 Insert a DATA card into the DATA slot. Set the protect switch of the DATA card to “off”.

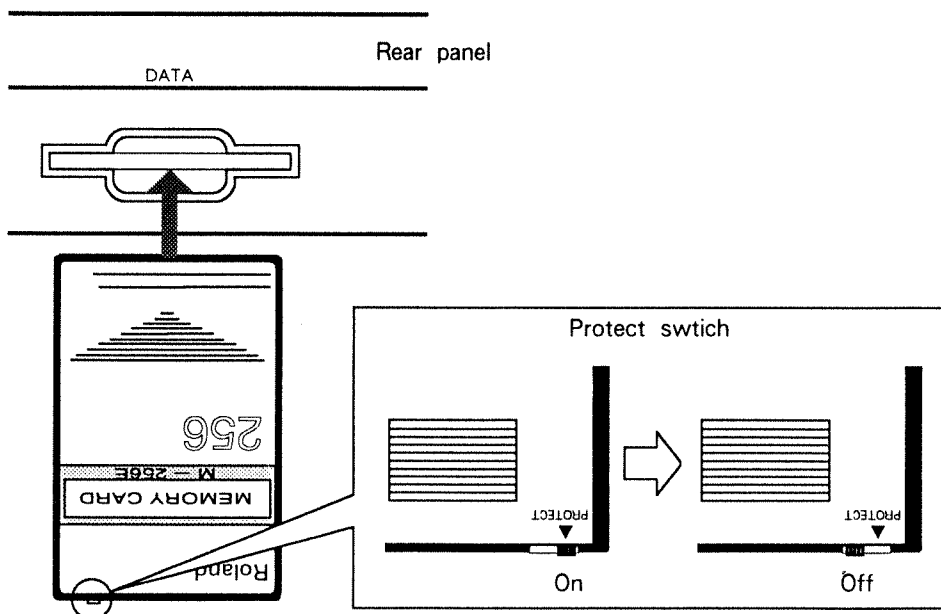

2. DATA TRANSFER WITH A CARD

Card save (INT → CRD)

① Press **DATA TRANSFER**.

② Press PAGE **▲▼** to select the "INT → CRD" display.

```
DATA TRANS INT→CRD
▶All Patch Setup [Y/N]
```

③ Press CURSOR **◀▶** to move the "▶" mark and to select the data that you wish to transfer.

```
DATA TRANS INT→CRD
All▶Patch Setup [Y/N]
```

④ To save the data, press **INC/YES**. To cancel without saving, press **DEC/NO**.

```
DATA TRANS INT→CRD
Completed
```

⑤ The display will return to the previous play screen.

*** In step ④, the following display will be shown when an un-initialized card is inserted.**

```
Wrong DATA card
overwright sure? [Y/N]
```

This screen is asking: (Is it O.K. to write all the data from the internal memory over that which is on the DATA card?)

All internal data will auto matically be transferred if you press **INC/YES**.

To cancel the operation, press **DEC/NO**. The display will return to the previous play screen.

By executing the above procedure, it is possible to read and write data to a DATA card conveniently without using the initialize function (⇐ P. IV - 2).

*** If the protect switch of the DATA card is on, the following display will appear in step ④, and you will not be able to continue the procedure.**

```
DATA card is Protected
```

If you wish to continue, set the protect switch of the DATA card to "off".

*** Use only the separately sold M-256E as a DARA card.**

Application ideas The Write operation also lets you save internal Patch data to a card, but handles only one Patch at a time. This means that you would have to perform the operation many times to save all Patches to a card. The Card Save operation saves all data in a single operation, which is often more convenient.

2. DATA TRANSFER WITH A CARD

Card load (CRD → INT)

● Card load

The Card Load operation loads data from a DATA card into the internal memory area. The data that was in the internal memory will be overwritten.

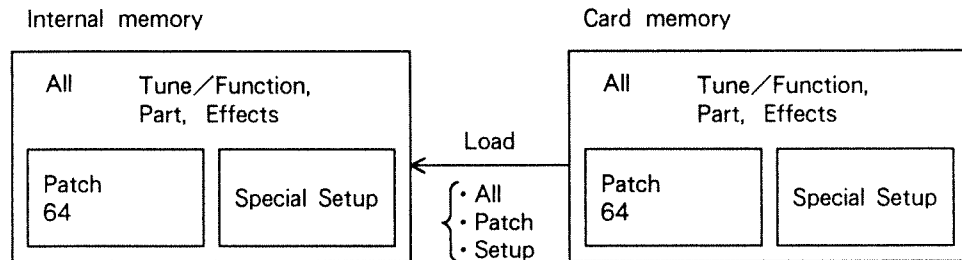

If you will be using both internal and card Patches, there is no need to use this operation.

【Data types】 [All, Patch, Setup]

All : All data for System (Tune/Function, Part, Effects), the 64 Patches (C-11 — C-88), and the Special Setup will be loaded.

Patch : The data for the 64 Patches (C-11 — C-88) will be loaded.

Setup : The data for the Special Setup will be loaded.

【Preparations】 Insert a DATA card into the DATA slot.

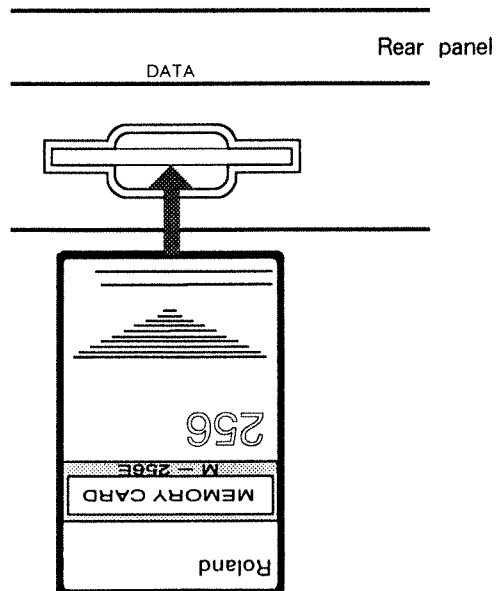

① Press **DATA TRANSFER**.

② Press PAGE **▲▼** to select the "CRD→INT" display.

```
DATA TRANS CRD→INT
▶All Patch Setup [Y/N]
```

③ Press CURSOR **◀▶** to move the "▶" mark and select the data that you wish to transfer.

```
DATA TRANS CRD→INT
All Patch▶Setup [Y/N]
```

④ Press **INC/YES** to load the data.

```
DATA TRANS CRD→INT
Completed
```

To cancel without loading, press **DEC/NO**.

```
DATA TRANS CRD→INT
Canceled
```

⑤ You will return to the previous play display.

* Executing this procedure will cause the data of the internal memory area to be re-written. If the internal memory contains data you wish to keep, be sure to save it to a different DATA card using the Card Save operation (☞ P. IV - 4), or save it to a sequencer using the Bulk Dump operation (☞ P. IV - 12).

* In step ④, the following display will appear briefly if a DATA card is not inserted.

```
DATA card is not ready
```

If you wish to continue, make sure that the DATA card is correctly inserted, and try again. To cancel the procedure, press **DEC/NO** or **EXIT**.

* Use only the separately sold M-256E as a DATA card.

2. DATA TRANSFER WITH A CARD

Exchange (INT ↔ CRD)

● Exchange

The Exchange operation exchanges data between the internal memory and the DATA card.

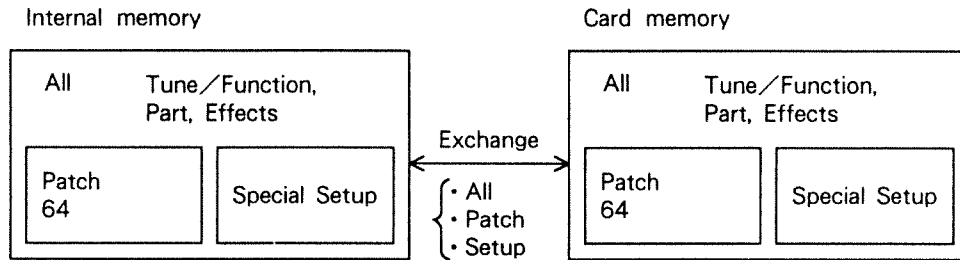

【Data types】 [All, Patch, Setup]

All : System (Tune/Function, Part, Effects), 64 patches and the Special Setup data will be exchanged.

Patch : The data of the 64 patches will be exchanged.

Setup : The Special Setup data will be exchanged.

【Preparations】 Insert a DATA card into the DATA slot. Set the protect switch of the DATA card to “off”.

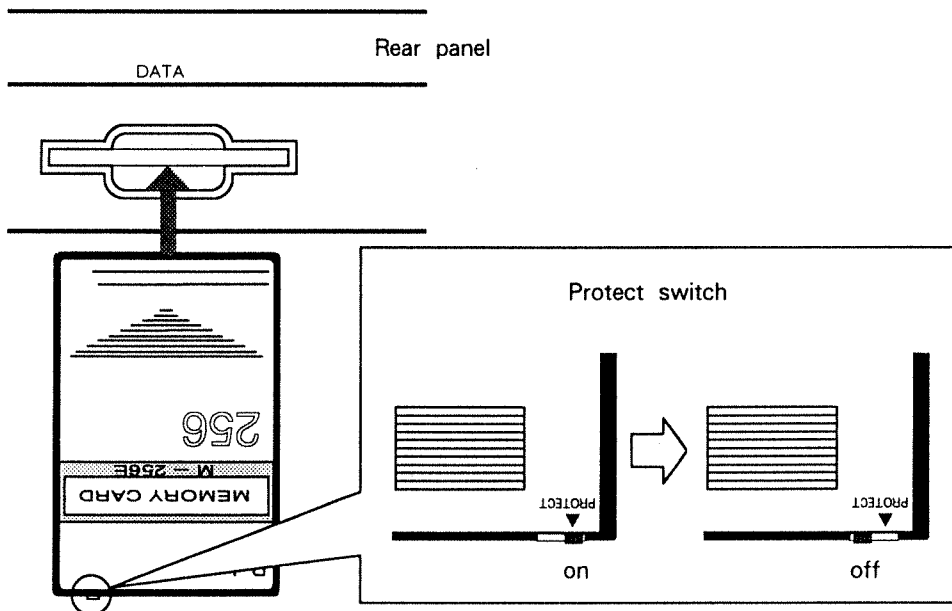

① Press **DATA TRANSFER**.

② Press PAGE **▲** **▼** to select the "INT ↔ CARD" display.

```
DATA TRANS INT↔CRD
▶All Patch Setup [Y/N]
```

③ Press CURSOR **◀** **▶** to move the "▶" mark and select the data that you wish to exchange.

```
DATA TRANS INT↔CRD
All▶Patch Setup [Y/N]
```

④ Press **INC/YES** to execute.

```
DATA TRANS INT↔CRD
Completed
```

To cancel without exchanging, press **DEC/NO**.

```
DATA TRANS INT↔CRD
Canceled
```

⑤ You will return to the previous play display.

*** If the protect switch of the DATA card is on, the following display will appear in step ④.**

```
DATA card is Protected
```

If you wish to continue, set the protect switch of the DATA card to "off".
*** Use only the separately sold M-256E as a DATA card.**

Application ideas

For example, if you execute the exchange function after saving the settings of your JD-800 (ALL) using Card Save (☞ P. IV - 4), you can then insert your settings into another JD-800. The previous settings can be restored by executing the exchange function a second time, so in this way, using one DATA card is very similar to having several JD-800 units. Although current settings can be transferred using Card Load (☞ P. IV - 6), or Bulk Dump (☞ P. IV - 12), the settings of the receiving device will be lost. Use the Exchange function when you don't want to lose the settings of the receiving device.

3. DATA TRANSFER WITH AN EXTERNAL DEVICE

● Patch dump

This operation transmits the data from the temporary area of the currently selected Patch or Special Setup (if you have modified parameter values, the edited data) as an Exclusive message to an external device.

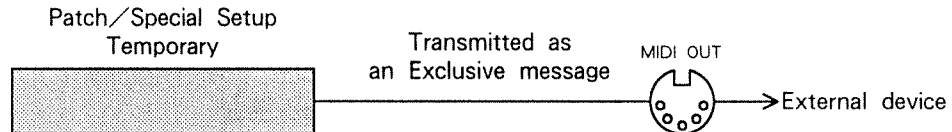

When program change messages are received, the data corresponding to the received program change number is called from the memory area into the temporary area, and the Patch or Special Setup will change. However, the Patch Dump operation transmits the data itself into the temporary area to rewrite it.

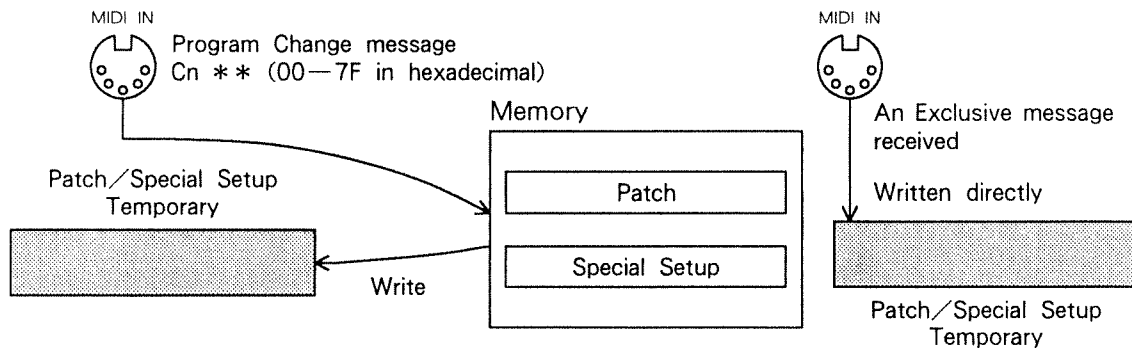

The result is the same as for a program change message. By saving edited Patches or Special Setup in a sequencer, you can ensure that your music will be played with the same Patch or Special Setup used when recording. It may be convenient to overdub this data at the beginning of the song.

【Connections】 Connect the JD-800 to a sequencer (or another JD-800) as shown below.

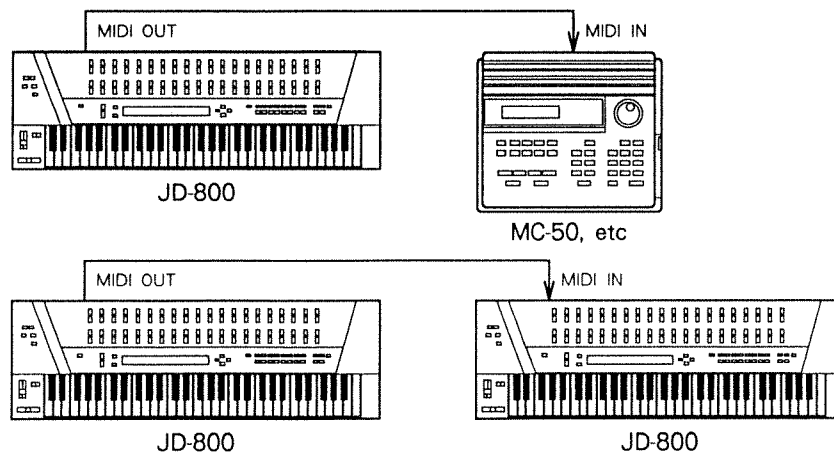

① Press **DATA TRANSFER**.

② Press PAGE **▲▼** to select the "following" display.

```
DATA TRANS
Patch dump      ? [Y/N]
```

③ Press **INC/YES** to transmit the data.

```
DATA TRANS
Completed
```

To cancel without transmitting, press **DEC/NO**.

```
DATA TRANS
Canceled
```

④ You will return to the previous play display.

* Patch dumped exclusive data can be received anytime except when in ROM play mode. When you want to receive exclusive data, leave the exclusive messages receiving (☐ P. III - 23) set to ON-1, or ON-2.

* For further information about the transmission of exclusive messages, refer to "Exclusive communications (☐ P. V - 58)".

3. DATA TRANSFER WITH AN EXTERNAL DEVICE

Bulk dump (INT → MIDI)

● Bulk dump

The transmission of all data in the internal memory area is called “bulk dump”. Internal data (patch, system, etc.) will be transmitted to a sequencer or to another JD-800 by exclusive message.

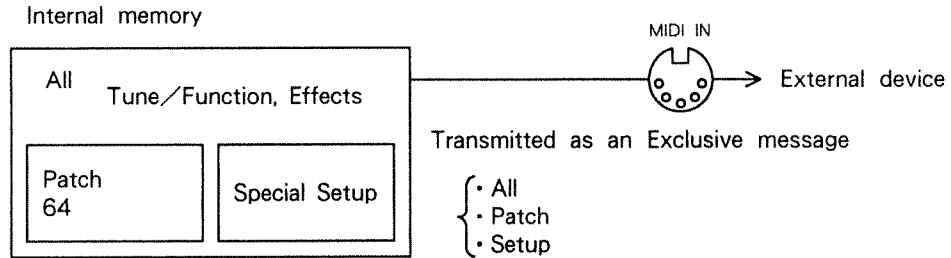

This operation can be used to save data in another device as a precaution against accidental loss of memory data.

【Data types】 [All, Patch, Setup]

All : System (Tune/Function, Effects), 64 patches, and the Special Setup data will be transmitted.

Patch : The 64 internal patches (I-11 — I-88) will be transmitted.

Setup : Setup: The Special Setup data will be transmitted.

【Connections】 Connect the JD-800 to a sequencer (or another JD-800) as shown below.

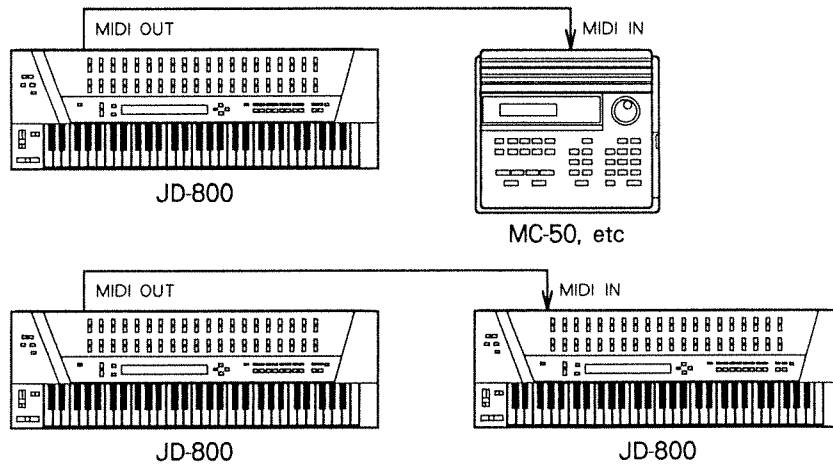

- ① Press **DATA TRANSFER**.
- ② Press PAGE **▲▼** to select the "INT → MIDI" display.

```
DATA TRANS INT→MIDI
▶All Patch Setup [Y/N]
```
- ③ Press CURSOR **◀▶** to move the "▶" mark and select the data that you wish to transmit.

```
DATA TRANS INT→MIDI
All Patch▶Setup [Y/N]
```
- ④ To dump the data, press **INC/YES**. Following display appeared while transmitting.

```
DATA TRANS INT→MIDI
Completed
```

To cancel without dumping, press **DEC/NO**.

```
DATA TRANS INT→MIDI
Canceled
```
- ⑤ You will return to the previous play display.

* Bulk dumped exclusive data can be received at any time except while in ROM Play mode. Be sure to set Exclusive Reception (☐ P. III – 23) to ON-1 or ON-2.

* For further information about the transmission of exclusive messages, refer to "Exclusive communications (☐ P. V – 58)".

Note

The Patch Dump operation also lets you transmit internal Patch data to an external device, but transmits only one Patch at a time. This means that you would have to perform the operation many times to transmit all Patches. The Bulk Dump operation dumps all Patch data in a single operation, which is often more convenient.

4. HOW TO RESTORE THE FACTORY SETTINGS

● Factory preset

This operation restores all data of the JD-800's internal memory area (System, Patch, Special Setup) to the factory settings.

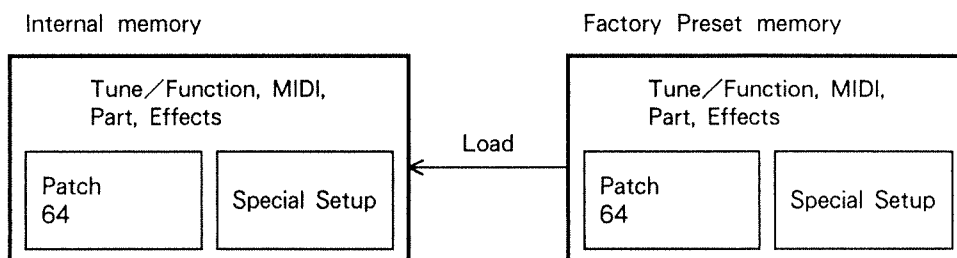

- ① Press **DATA TRANSFER**.
- ② Press PAGE **▲▼** to select the "following" display.

```
Factory preset
                ? [Y/N]
```

- ③ To restore the factory data, press **INC/YES**.

```
Factory preset
                Completed
```

To cancel without resetting, press **DEC/NO**.

```
Factory preset
                Canceled
```

- ④ You will return to the previous play display.

***This operation is provided only for use in emergencies, such as when the internal memory data has been lost by some accident. In order to avoid losing important data, use this operation only when absolutely necessary.**

Section V

Appendix

V

IDEAS FOR CREATING YOUR OWN SOUNDS

This section will give some ideas for creating various types of sounds in Single mode. Refer to the Patch charts and the list of points, and try creating your very own sounds.

* Blank areas in the charts do not need to be specified.

● String section

Here's how to create a "string section" sound such as synth-strings.

- ① Select a wave that contains many partials, such as #001:Syn Saw 1.
- ② Set the filter to LPF, and adjust the TVF cutoff as desired.
- ③ For the TVA envelope, make the attack (T1) slightly slower, and lengthen the release (T4).
- ④ If you set the TVF envelope Velocity Sensitivity to about +40, you can control the volume with your keyboard dynamics.
- ⑤ To simulate an ensemble of multiple instruments, layer two or three Tones.
- ⑥ Set the Pitch Fine of each Tone to slightly different values.
- ⑦ Apply the LFO to the pitch. If you change the LFO Rate and Depth for each Tone, the sound will be modulated, making it richer and more interesting. In particular, if you set a very slow Rate and a slight Depth, the sound will modulate slowly.
- ⑧ Use effects such as EQ/Chorus/Reverb.
- ⑨ Taking into account the overall balance you want, use the EQ to slightly boost the low range (below 400 Hz) to give the sound more weight.
- ⑩ For the Chorus effect, set a fairly low Rate, a feedback of 0, and a fairly long (about 26ms) Delay. This will spread the sound more widely between left and right.
- ⑪ For the Reverb effect, select a Hall-type effect for Type, and set a fairly long Time (about 3 seconds).

[Sample settings]

| PATCH COMMON | | | | | | | | | | PATCH EFFECTS | | | | | | | | | |
|--------------|--------------|---------|-----------|-------------|-----------------|----------------|------------|------|-------|-----------------------|---------|----------|---------|----------|---------------------|------|-----|--|--|
| Patch Name | | | | | Patch Name | | | | | Group A sequence/SW | | | | | Group B Sequence/SW | | | | |
| - | | | | | Strings section | | | | | OFF → OFF → OFF → OFF | | | | | CH → RV → OFF | | | | |
| Level | Bender | | Atouch | | Solo | | Portamento | | | Distortion | | | | | Phaser | | | | |
| | Down | Up | band sens | | SW | Legato | SW | Mode | Time | Type | Drive | Level | Manual | Rate | Depth | Reso | Mix | | |
| 100 | 02 | 02 | 00 | | OFF | | OFF | | | | | Hz | Hz | | | | | | |
| Key Range | | | | | | | | | | Spectrum | | | | | Enhancer | | | | |
| Tone A | | Tone B | | Tone C | | Tone D | | | Band1 | Band2 | Band3 | Band4 | Band5 | Band6 | Width | Sens | Mix | | |
| Low | High | Low | High | Low | High | Low | High | Low | High | | | | | | | | | | |
| C-1 | G9 | C-1 | G9 | C-1 | G9 | C-1 | G9 | | | | | | | | | | | | |
| EQ | | | | | | | | | | Dry/Effect | | | | | Chorus | | | | |
| L-freq | L-gain | M-freq | Mid-Q | M-gain | H-freq | H-gain | | | | Balance B | Rate | Depth | D-time | Feedback | Level | | | | |
| 400Hz | +03dB | 1kHz | 0.5 | 00dB | 4kHz | 00dB | | | | D: 37 E: 63 | 0.5Hz | 31 | 26.0ms | 00% | 80 | | | | |
| MIDI Tx | | | | | | | | | | Delay | | | | | Reverb | | | | |
| Mode | Split Point | Channel | | Prog change | | Hold mode | | | C-tap | C-level | L-tap | L-level | R-tap | R-level | Feedback | | | | |
| | | Lower | Upper | Lower | Upper | | | | ms | | ms | | ms | | % | | | | |
| TONES | | | | | | | | | | Type | Pre dly | ER level | HF damp | Time | Level | | | | |
| Layer | | A | B | C | D | HALL1 | | 28ms | 40 | 5kHz | 2.7s | 50 | | | | | | | |
| Active | Hold control | ON | ON | ON | OFF | TONES | | A | B | C | D | | | | | | | | |
| COM | Velo curve | 03 | 03 | 03 | | Filter mode | LPF | LPF | LPF | | | | | | | | | | |
| LFO 1 | Rate | 70 | 74 | 61 | | Cutoff freq | 61 | 61 | 61 | | | | | | | | | | |
| | Delay | 00 | 00 | 00 | | Resonance | 00 | 00 | 00 | | | | | | | | | | |
| | Fade | 00 | 00 | 00 | | ENV depth | +24 | +24 | 00 | | | | | | | | | | |
| | Waveform | TRI | TRI | TRI | | Cutoff KF | 65 | 65 | 65 | | | | | | | | | | |
| | Offset | 0 | 0 | 0 | | LFO select | 2 | 2 | 2 | | | | | | | | | | |
| | Key trigger | ON | ON | ON | | LFO depth | 00 | 00 | 00 | | | | | | | | | | |
| | | | | | | Atouch sens | 00 | 00 | 00 | | | | | | | | | | |
| LFO 2 | Rate | | | | | Velo sens | +50 | +50 | 00 | | | | | | | | | | |
| | Delay | | | | | Time velo | 00 | 00 | 00 | | | | | | | | | | |
| | Fade | | | | | Time KF | 00 | 00 | 00 | | | | | | | | | | |
| | Waveform | | | | | Time 1 | 00 | 00 | 00 | | | | | | | | | | |
| | Offset | | | | | Level 1 | 100 | 100 | 100 | | | | | | | | | | |
| | Key trigger | | | | | Time 2 | 00 | 00 | 00 | | | | | | | | | | |
| | | | | | | Level 2 | 100 | 100 | 100 | | | | | | | | | | |
| WG | Pitch coarse | 00 | 00 | -12 | | Time 3 | 00 | 00 | 00 | | | | | | | | | | |
| | Pitch fine | -02 | +02 | 00 | | Sus level | 100 | 100 | 100 | | | | | | | | | | |
| | Pitch random | 00 | 00 | 20 | | Time 4 | 66 | 66 | 66 | | | | | | | | | | |
| | Pitch KF | 100 | 100 | 100 | | Level 4 | 00 | 00 | 00 | | | | | | | | | | |
| | Atouch bend | OFF | OFF | OFF | | Level | 100 | 100 | 100 | | | | | | | | | | |
| | Bender | ON | ON | ON | | Bias direction | UP | UP | UP | | | | | | | | | | |
| | Waveform | 001 | 001 | 001 | | Bias point | C4 | C4 | C4 | | | | | | | | | | |
| PITCH ENV | Wave source | INT | INT | INT | | Bias level | 00 | 00 | 00 | | | | | | | | | | |
| | Atouch sens | 00 | 00 | 00 | | Atouch sens | 00 | 00 | 00 | | | | | | | | | | |
| | LFO 1 depth | +10 | +10 | +10 | | LFO select | 2 | 2 | 2 | | | | | | | | | | |
| | LFO 2 depth | 00 | 00 | 00 | | LFO depth | 00 | 00 | 00 | | | | | | | | | | |
| | Lever sens | 24 | 24 | 24 | | Velo sens | +40 | +40 | +40 | | | | | | | | | | |
| | Velo sens | 00 | 00 | 00 | | Time velo | +50 | +50 | +50 | | | | | | | | | | |
| | Time velo | 00 | 00 | 00 | | Time KF | +02 | +02 | +02 | | | | | | | | | | |
| TVF | Time KF | 00 | 00 | 00 | | Time 1 | 64 | 64 | 64 | | | | | | | | | | |
| | Level 0 | 00 | 00 | 00 | | Level 1 | 100 | 100 | 100 | | | | | | | | | | |
| | Time 1 | 00 | 00 | 00 | | Time 2 | 77 | 77 | 77 | | | | | | | | | | |
| | Level 1 | 00 | 00 | 00 | | Level 2 | 80 | 80 | 80 | | | | | | | | | | |
| | Time 2 | 00 | 00 | 00 | | Time 3 | 00 | 00 | 00 | | | | | | | | | | |
| | Level 2 | 00 | 00 | 00 | | Sus level | 80 | 80 | 80 | | | | | | | | | | |
| | Time 3 | 00 | 00 | 00 | | Time 4 | 68 | 68 | 68 | | | | | | | | | | |
| | Level 2 | 00 | 00 | 00 | | | | | | | | | | | | | | | |
| | | | | | | | | | | | | | | | | | | | |
| | | | | | | | | | | | | | | | | | | | |

● String solo

Here's how to create a "solo string" sound such as violin or cello.

- ① Use two Tones. For one Tone, select Wave #007 and use it to create the sustain component of the sound. For the other Tone, select Wave #068 and use it to create the attack component of the sound when the bow scrapes the string.

- ② Set the TVA envelopes of each as follows.

《Tone A (sustain component)》

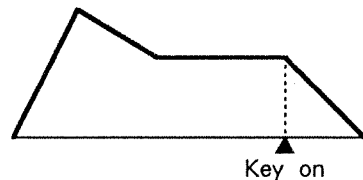

《Tone B (attack component)》

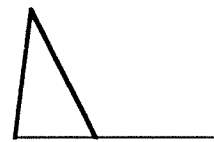

- ③ For the sustain component Tone, make appropriate LFO Delay and Fade (+) settings so that vibrato is gradually applied after a while.
- ④ Set the TVA ENV Velocity Sensitivity and the TVF ENV Velocity Sensitivity to about +30 so that key velocity will simultaneously control both volume and tone.
- ⑤ Make TVA ENV Time Velocity Sensitivity settings so that velocity can be used to make the attack faster or slower.
- ⑥ Use effects such as EQ/Enhancer/Reverb.
- ⑦ Use the EQ to slightly boost the mid range. Appropriate settings are Frequency at 1 kHz, Q at 0.5, and Gain at +6 dB.
- ⑧ The Enhancer effect will add brilliance to the string sound.
- ⑨ For the Reverb effect, a room-type effect with a fairly short Time (1 sec) will create the feeling of a small room.
- ⑩ When playing this sound, turn on Solo/Portamento. Set Solo Legato on, the Portamento Mode to Legato, and the Portamento Time to about 26. With these settings, the attack sound will be heard only for staccato playing, and will not be heard for legato playing.

[Sample settings]

| PATCH COMMON | | | | | | | | | | PATCH EFFECTS | | | | | | | | | |
|--------------|--------------|---------|------------------|-------------|------------|------------|--------|-------|-------|----------------------|---------|-------------|---------|--------|---------------------|----------|--|--|--|
| Patch Name | | | | | Patch Name | | | | | Group A sequence/SW | | | | | Group B Sequence/SW | | | | |
| - | | | | | Brass Solo | | | | | EN → OFF → OFF → OFF | | | | | CH → OFF → OFF | | | | |
| Level | Bender | | Atouch bend sens | Solo | | Portamento | | | Type | Drive | Level | Distortion | | | Phaser | | | | |
| | Down | Up | | SW | Legato | SW | Mode | Time | | | | Manual | Rate | Depth | Reso | Mix | | | |
| 100 | 02 | 02 | 00 | on | off | OFF | LEGATO | 26 | | | | | | | | | | | |
| Key Range | | | | | | | | | | Spectrum | | | | | Enhancer | | | | |
| Tone A | | Tone B | | Tone C | | Tone D | | Band1 | Band2 | Band3 | Band4 | Band5 | Band6 | Width | Sens | Mix | | | |
| Low | High | Low | High | Low | High | Low | High | | | | | | | | 58 | 40 | | | |
| C-1 | G9 | C-1 | G9 | | | | | | | | | | | | | | | | |
| EQ | | | | | | | | | | Dry/Effect Balance B | | | | | Chorus | | | | |
| L-freq | L-gain | M-freq | Mid-Q | M-gain | H-freq | H-gain | | | | D: 68 | E: 32 | Rate | Depth | D-time | Feedback | Level | | | |
| 400Hz | 00dB | 1kHz | 0.5 | +06dB | 4kHz | 00dB | | | | | | | | | % | | | | |
| MIDI TX | | | | | | | | | | Delay | | | | | Reverb | | | | |
| Mode | Split Point | Channel | | Prog change | | Hold mode | | | | C-tap | C-level | L-tap | L-level | R-tap | R-level | Feedback | | | |
| | | Lower | Upper | Lower | Upper | | | | | ms | | ms | | ms | | % | | | |
| TONES | | | | | | | | | | Type | Pre dly | ER level | HF damp | Time | Level | | | | |
| | | | | | | | | | | ROOM2 | 00ms | 00 | 4kHz | 1.0s | 67 | | | | |
| Layer | | | | | | | | | | A | | B | | C | | D | | | |
| Active | | | | | | | | | | ON | | OFF | | OFF | | OFF | | | |
| COM | Hold control | ON | | OFF | | | | | | TVF | | Filter mode | LPF | LPF | | | | | |
| | Velo curve | 03 | | 04 | | | | | | Cutoff freq | 63 | 7558 | | | | | | | |
| | Rate | 73 | | | | | | | | Resonance | 00 | 00 | | | | | | | |
| LFO 1 | Delay | 49 | | | | | | | | ENV depth | +29 | +50 | | | | | | | |
| | Fade | +22 | | | | | | | | Cutoff KF | 00 | 00 | | | | | | | |
| | Waveform | TRI | | | | | | | | LFO select | 2 | 2 | | | | | | | |
| | Offset | 0 | | | | | | | | LFO depth | 00 | 00 | | | | | | | |
| | Key trigger | OFF | | | | | | | | Atouch sens | 00 | 00 | | | | | | | |
| LFO 2 | Rate | 81 | | | | | | | | Velo sens | +35 | +50 | | | | | | | |
| | Delay | 00 | | | | | | | | Time velo | 00 | 00 | | | | | | | |
| | Fade | 00 | | | | | | | | Time KF | 00 | 00 | | | | | | | |
| | Waveform | TRI | | | | | | | | Time 1 | 25 | 52 | | | | | | | |
| | Offset | 0 | | | | | | | | Level 1 | 100 | 100 | | | | | | | |
| WG | Key trigger | OFF | | | | | | | | Time 2 | 38 | 50 | | | | | | | |
| | Pitch coarse | -12 | | -11 | | | | | | Level 2 | 32 | 00 | | | | | | | |
| | Pitch fine | 00 | | 00 | | | | | | Time 3 | 40 | 00 | | | | | | | |
| | Pitch randam | 00 | | 00 | | | | | | Sus level | 25 | 00 | | | | | | | |
| | Pitch KF | 100 | | 100 | | | | | | Time 4 | 60 | 20 | | | | | | | |
| PITCH ENV | Atouch bend | OFF | | OFF | | | | | | Level 4 | 50 | 00 | | | | | | | |
| | Bender | ON | | OFF | | | | | | Level | 100 | 100 | | | | | | | |
| | Waveform | 007 | | 068 | | | | | | Bias direction | UP | UP | | | | | | | |
| | Wave source | INT | | INT | | | | | | Bias point | C4 | C4 | | | | | | | |
| | Atouch sens | 00 | | 00 | | | | | | Bias level | 00 | 00 | | | | | | | |
| TVA | LFO 1 depth | +13 | | 00 | | | | | | Atouch sens | 00 | 00 | | | | | | | |
| | LFO 2 depth | 00 | | 00 | | | | | | LFO select | 2 | 2 | | | | | | | |
| | Lever sens | 29 | | 00 | | | | | | LFO depth | 00 | 00 | | | | | | | |
| | Velo sens | 00 | | 00 | | | | | | Velo sens | +33 | +50 | | | | | | | |
| | Time velo | 00 | | 00 | | | | | | Time velo | +50 | -24 | | | | | | | |
| TVA ENV | Time KF | 00 | | 00 | | | | | | Time KF | +02 | +06 | | | | | | | |
| | Level 0 | 00 | | 00 | | | | | | Time 1 | 59 | 17 | | | | | | | |
| | Time 1 | 00 | | 00 | | | | | | Level 1 | 100 | 100 | | | | | | | |
| | Level 1 | 00 | | 00 | | | | | | Time 2 | 85 | 26 | | | | | | | |
| | Time 2 | 00 | | 00 | | | | | | Level 2 | 78 | 00 | | | | | | | |

● Brass section

Here's how to create a "brass section" sound such as synth brass.

- ① Select a waveform that contains many partials, such as #001:Syn Saw 1.
- ② Use the filter in LPF mode, and adjust the TVF cutoff as desired.
- ③ Set the TVF envelope Attack to be slightly slower than the TVA envelope. This will create change in tone as the sound begins.

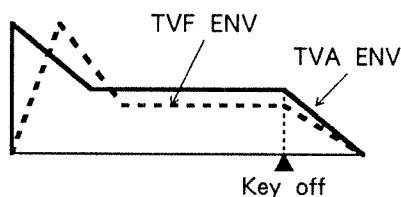

- ④ To simulate an ensemble of multiple instruments, layer two or three Tones.
- ⑤ Set the Pitch Coarse of each Tone to an octave apart, and the Pitch Fine to about ± 2 to create a detune effect that will make the sound richer.
- ⑥ Apply the LFO to the pitch of one Tone. Make settings so that the pitch is slightly lower when the sound begins, and then rises to match the pitch of the other Tones.

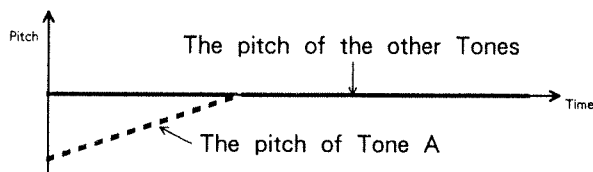

- ⑦ Effects such as EQ/Enhancer/Reverb are suitable.
- ⑧ Use the EQ to slightly boost the low range (below 400 Hz) about +6 dB to give the sound more weight.
- ⑨ The Enhancer will make the sound more "up-front" in the mix.
- ⑩ Use the Chorus effect to spread the sound more widely between left and right.
- ⑪ For the Reverb effect, select a Hall-type effect for Type, and set a fairly short Time.
- ⑫ Make settings so that the aftertouch will brighten the sound (i.e., so that aftertouch will open the filter).

[Sample settings]

| PATCH COMMON | | | | | | | | | | PATCH EFFECTS | | | | | | | | | |
|---------------|-------------|---------|-------|-------------|------------|-----------|------|----------------|-------|---------------------|---------|----------|---------|----------|---------------------|----------|-----|--|--|
| Patch Name | | | | | Patch Name | | | | | Group A sequence/SW | | | | | Group B Sequence/SW | | | | |
| Brass Section | | | | | | | | | | EN OFF OFF OFF | | | | | CH RV OFF | | | | |
| Level | | Bender | | Atouch | | Solo | | Portamento | | Distortion | | | | | Phase | | | | |
| 100 | | 02 02 | | 00 | | OFF | | OFF | | Type | Drive | Level | Manual | Rate | Depth | Reso | Mix | | |
| Key Range | | | | | | | | | | Spectrum | | | | | | Enhancer | | | |
| Tone A | | Tone B | | Tone C | | Tone D | | Band1 | Band2 | Band3 | Band4 | Band5 | Band6 | Width | Sens | Mix | | | |
| Low | High | Low | High | Low | High | Low | High | | | | | | | | 46 | 50 | | | |
| C-1 | G9 | C-1 | G9 | C-1 | G9 | | | | | | | | | | | | | | |
| EQ | | | | | | | | | | Dry/Effect | | | | | Chorus | | | | |
| L-freq | L-gain | M-freq | Mid-Q | M-gain | H-freq | H-gain | | | | Balance B | Rate | Depth | D-time | Feedback | Level | | | | |
| 400Hz | +06dB | 1kHz | 0.5 | 00dB | 4kHz | 00dB | | | | D:40 E:60 | 0.5Hz | 31 | 26.0ms | 00% | | | | | |
| MIDI Tx | | | | | | | | | | Delay | | | | | Reverb | | | | |
| Mode | Split Point | Channel | | Prog change | | Hold mode | | | | C-tap | C-level | L-tap | L-level | R-tap | R-level | Feedback | | | |
| | | Lower | Upper | Lower | Upper | | | | | ms | | ms | | ms | | % | | | |
| TONES | | | | | | | | | | Type | Pre dly | ER level | HF damp | Time | Level | | | | |
| Layer | | | | A | B | C | D | HALL1 | 28ms | 48 | 16kHz | 1.7s | 30 | | | | | | |
| Active | | | | ON | ON | ON | OFF | TONES | | | | | | | | | | | |
| Hold control | | | | ON | ON | ON | OFF | A | B | C | D | | | | | | | | |
| Velo curve | | | | 03 | 03 | 03 | | Filter mode | LPF | LPF | LPF | | | | | | | | |
| Rate | | | | 78 | 78 | 78 | | Cutoff freq | 58 | 58 | 58 | | | | | | | | |
| Delay | | | | 00 | 00 | 00 | | Resonance | 00 | 00 | 00 | | | | | | | | |
| Fade | | | | 00 | 00 | 00 | | ENV depth | +23 | +23 | +23 | | | | | | | | |
| Waveform | | | | TRI | TRI | TRI | | Cutoff KF | 65 | 65 | 65 | | | | | | | | |
| Offset | | | | 0 | 0 | 0 | | LFO select | 2 | 2 | 2 | | | | | | | | |
| Key trigger | | | | OFF | OFF | OFF | | LFO depth | 00 | 00 | 00 | | | | | | | | |
| Rate | | | | | 64 | | | Atouch sens | +16 | +16 | 00 | | | | | | | | |
| Delay | | | | | 00 | | | Velo sens | 00 | 00 | 00 | | | | | | | | |
| Fade | | | | | -17 | | | Time velo | +20 | +20 | +20 | | | | | | | | |
| Waveform | | | | | SAW | | | Time KF | +10 | +10 | +10 | | | | | | | | |
| Offset | | | | | 0 | | | Time 1 | 34 | 34 | 34 | | | | | | | | |
| Key trigger | | | | | ON | | | Level 1 | 100 | 100 | 100 | | | | | | | | |
| Pitch coarse | | | | 00 | 00 | -12 | | Time 2 | 62 | 62 | 62 | | | | | | | | |
| Pitch fine | | | | -02 | +02 | 00 | | Level 2 | 52 | 52 | 52 | | | | | | | | |
| Pitch random | | | | 00 | 00 | 00 | | Time 3 | 00 | 00 | 00 | | | | | | | | |
| Pitch KF | | | | 100 | 100 | 100 | | Sus level | 52 | 52 | 52 | | | | | | | | |
| Atouch bend | | | | OFF | OFF | OFF | | Time 4 | 31 | 31 | 31 | | | | | | | | |
| Bender | | | | ON | ON | ON | | Level 4 | 00 | 00 | 00 | | | | | | | | |
| Waveform | | | | 001 | 001 | 001 | | Level | 100 | 100 | 100 | | | | | | | | |
| Wave source | | | | INT | INT | INT | | Bias direction | UP | UP | UP | | | | | | | | |
| Atouch sens | | | | 00 | 00 | 00 | | Bias point | C4 | C4 | C4 | | | | | | | | |
| LFO 1 depth | | | | 00 | 00 | 00 | | Bias level | 00 | 00 | 00 | | | | | | | | |
| LFO 2 depth | | | | 00 | -32 | 00 | | Atouch sens | 00 | 00 | 00 | | | | | | | | |
| Lever sens | | | | 29 | 29 | 29 | | LFO select | 2 | 2 | 2 | | | | | | | | |
| Velo sens | | | | 00 | 00 | 00 | | LFO depth | 00 | 00 | 00 | | | | | | | | |
| Time velo | | | | 00 | 00 | 00 | | Velo sens | +28 | +28 | +28 | | | | | | | | |
| Time KF | | | | 00 | 00 | 00 | | Time velo | +16 | +16 | +16 | | | | | | | | |
| Level 0 | | | | 00 | 00 | 00 | | Time KF | +02 | +02 | +02 | | | | | | | | |
| Time 1 | | | | 00 | 00 | 00 | | Time 1 | 00 | 00 | 00 | | | | | | | | |
| Level 1 | | | | 00 | 00 | 00 | | Level 1 | 100 | 100 | 100 | | | | | | | | |
| Time 2 | | | | 00 | 00 | 00 | | Level 2 | 78 | 78 | 78 | | | | | | | | |
| Level 2 | | | | 00 | 00 | 00 | | Time 3 | 00 | 00 | 00 | | | | | | | | |
| Time 3 | | | | 00 | 00 | 00 | | Level 1 | 100 | 100 | 100 | | | | | | | | |
| Level 2 | | | | 00 | 00 | 00 | | Level 2 | 78 | 78 | 78 | | | | | | | | |
| Time 4 | | | | 00 | 00 | 00 | | Time 3 | 00 | 00 | 00 | | | | | | | | |
| Level 2 | | | | 00 | 00 | 00 | | Sus level | 78 | 78 | 78 | | | | | | | | |
| | | | | | | | | Time 4 | 30 | 30 | 30 | | | | | | | | |

● Brass solo

Here's how to create a "brass solo" sound such as trumpet or horn.

- ① Select a waveform that is similar to the acoustic sound, such as #096 or #097, or a waveform that contains many partials such as #001 — 003.
- ② Use the filter in LPF mode, and set a fairly high cutoff frequency. Slightly raise the resonance, to add character to the sound.
- ③ Set the TVF/TVA envelopes as follows.

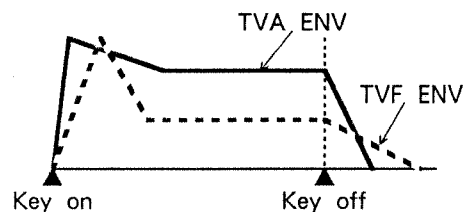

- ④ To simulate unsteady pitch during the attack, set the Pitch Envelope as follows.

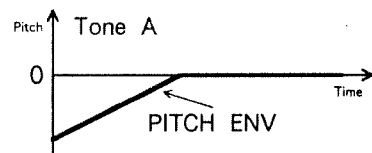

- ⑤ Make LFO1 and LFO1 Depth settings so that vibrato is faded in during the sustain.
- ⑥ Use effects such as EQ/Enhancer/Reverb.
- ⑦ Use the EQ to slightly boost the appropriate range for the sound you are creating. For horn, boost the low range; for trombone, the mid range; and for trumpet, the high range.
- ⑧ The Enhancer will give the sound more brilliance.
- ⑨ For the Reverb effect, select a Hall-type effect, and set a fairly long Time to create a solo-type feeling.
- ⑩ When playing this sound, turn on Solo/Portamento. Set Solo Legato off, the Portamento Mode to Legato, and the Portamento Time to about 30. With these settings, the attack sound will be heard only for staccato playing, and will not be heard for legato playing.

[Sample settings]

| PATCH COMMON | | | | | | | | | | PATCH EFFECTS | | | | | | | | | | | | | | | | | | | | | | | | | | | | | |
|--------------|--------------|---------|-----------|-------------|------------|-----------|-------------|--------|------|------------------------|-------|-------|--------|-------|---------------------|----------|-------|-------|--|----------|--|-------|--------|-------|---------|------|--|------|--|------|--|--|----|--|-------|--|--|--|--|
| Patch Name | | | | | Patch Name | | | | | Group A sequence/SW | | | | | Group B Sequence/SW | | | | | | | | | | | | | | | | | | | | | | | | |
| - | | | | | Brass Solo | | | | | OFF → OFF → OFF → EN → | | | | | RV → OFF → OFF | | | | | | | | | | | | | | | | | | | | | | | | |
| Level | Bender | | Atouch | | Solo | | Portamento | | | Distortion | | | | | Phaser | | | | | | | | | | | | | | | | | | | | | | | | |
| | Down | Up | bend sens | | SW | Legato | SW | Mode | Time | Type | Drive | Level | Manual | Rate | Depth | Reso | Mix | | | | | | | | | | | | | | | | | | | | | | |
| 100 | 02 | 02 | 00 | | ON | OFF | ON | LEGATO | 30 | | | | Hz | Hz | | | | | | | | | | | | | | | | | | | | | | | | | |
| Key Range | | | | | | | | | | Spectrum | | | | | | | | | | | | | | | | | | | | | | | | | | | | | |
| Tone A | | Tone B | | Tone C | | Tone D | | Band1 | | | | | Band2 | | | Band3 | | Band4 | | Band5 | | Band6 | | Width | | Sens | | Mix | | | | | | | | | | | |
| Low | High | Low | High | Low | High | Low | High | | | | | | | | | | | | | | | | | 71 | | 36 | | | | | | | | | | | | | |
| C-1 | G9 | | | | | | | | | | | | | | | | | | | | | | | | | | | | | | | | | | | | | | |
| EQ | | | | | | | | | | Dry/Effect | | | | | Chorus | | | | | | | | | | | | | | | | | | | | | | | | |
| L-freq | L-gain | M-freq | Mid-Q | M-gain | H-freq | H-gain | D: 50 E: 50 | | | | | Rate | | Depth | D-time | Feedback | Level | | | | | | | | | | | | | | | | | | | | | | |
| 400Hz | 00dB | 800Hz | 0.5 | +06dB | 4kHz | 00dB | | | | | | Hz | | | ms | % | | | | | | | | | | | | | | | | | | | | | | | |
| MIDI Tx | | | | | | | | | | C-tap | | | | | Delay | | | | | | | | | | | | | | | | | | | | | | | | |
| Mode | Split Point | Channel | | Prog change | | Hold mode | | ms | | | | | ms | | | | | | | | | | | | | | | | | | | | | | | | | | |
| | | Lower | Upper | Lower | Upper | | | | | | | | | | | | | | | | | | | | | | | | | | | | | | | | | | |
| TONES | | | | | | | | | | Type | | | | | Pre dly | | | | | ER level | | | | | HF damp | | | | | Time | | | | | Level | | | | |
| A | | B | | C | | D | | HALL4 | | | | | 00ms | | | | | 48 | | | | | 2.5kHz | | | | | 3.5s | | | | | 43 | | | | | | |
| Layer | ON | OFF | OFF | OFF | OFF | | | | | | | | | | | | | | | | | | | | | | | | | | | | | | | | | | |
| Active | ON | OFF | OFF | OFF | OFF | | | | | | | | | | | | | | | | | | | | | | | | | | | | | | | | | | |
| LFO 1 | Hold control | ON | | | | | | | | | | | | | | | | | | | | | | | | | | | | | | | | | | | | | |
| | Velo curve | 3 | | | | | | | | | | | | | | | | | | | | | | | | | | | | | | | | | | | | | |
| | Rate | 80 | | | | | | | | | | | | | | | | | | | | | | | | | | | | | | | | | | | | | |
| | Delay | 54 | | | | | | | | | | | | | | | | | | | | | | | | | | | | | | | | | | | | | |
| LFO 2 | Fade | +29 | | | | | | | | | | | | | | | | | | | | | | | | | | | | | | | | | | | | | |
| | Waveform | TRI | | | | | | | | | | | | | | | | | | | | | | | | | | | | | | | | | | | | | |
| | Offset | 0 | | | | | | | | | | | | | | | | | | | | | | | | | | | | | | | | | | | | | |
| | Key trigger | ON | | | | | | | | | | | | | | | | | | | | | | | | | | | | | | | | | | | | | |
| WG | Rate | 81 | | | | | | | | | | | | | | | | | | | | | | | | | | | | | | | | | | | | | |
| | Delay | 00 | | | | | | | | | | | | | | | | | | | | | | | | | | | | | | | | | | | | | |
| | Fade | 00 | | | | | | | | | | | | | | | | | | | | | | | | | | | | | | | | | | | | | |
| | Waveform | TRI | | | | | | | | | | | | | | | | | | | | | | | | | | | | | | | | | | | | | |
| PITCH ENV | Offset | 0 | | | | | | | | | | | | | | | | | | | | | | | | | | | | | | | | | | | | | |
| | Key trigger | ON | | | | | | | | | | | | | | | | | | | | | | | | | | | | | | | | | | | | | |
| | Pitch coarse | 00 | | | | | | | | | | | | | | | | | | | | | | | | | | | | | | | | | | | | | |
| | Pitch fine | 00 | | | | | | | | | | | | | | | | | | | | | | | | | | | | | | | | | | | | | |
| TVA | Pitch randam | 00 | | | | | | | | | | | | | | | | | | | | | | | | | | | | | | | | | | | | | |
| | Pitch KF | 100 | | | | | | | | | | | | | | | | | | | | | | | | | | | | | | | | | | | | | |
| | Atouch bend | OFF | | | | | | | | | | | | | | | | | | | | | | | | | | | | | | | | | | | | | |
| | Bender | ON | | | | | | | | | | | | | | | | | | | | | | | | | | | | | | | | | | | | | |
| TVA | Waveform | 096 | | | | | | | | | | | | | | | | | | | | | | | | | | | | | | | | | | | | | |
| | Wave source | INT | | | | | | | | | | | | | | | | | | | | | | | | | | | | | | | | | | | | | |
| | Atouch sens | 00 | | | | | | | | | | | | | | | | | | | | | | | | | | | | | | | | | | | | | |
| | LFO 1 depth | +15 | | | | | | | | | | | | | | | | | | | | | | | | | | | | | | | | | | | | | |
| TVA | LFO 2 depth | 00 | | | | | | | | | | | | | | | | | | | | | | | | | | | | | | | | | | | | | |
| | Lever sens | 20 | | | | | | | | | | | | | | | | | | | | | | | | | | | | | | | | | | | | | |
| | Velo sens | +33 | | | | | | | | | | | | | | | | | | | | | | | | | | | | | | | | | | | | | |
| | Time velo | 00 | | | | | | | | | | | | | | | | | | | | | | | | | | | | | | | | | | | | | |
| TVA | Time KF | 00 | | | | | | | | | | | | | | | | | | | | | | | | | | | | | | | | | | | | | |
| | Level 0 | -24 | | | | | | | | | | | | | | | | | | | | | | | | | | | | | | | | | | | | | |
| | Time 1 | 18 | | | | | | | | | | | | | | | | | | | | | | | | | | | | | | | | | | | | | |
| | Level 1 | 00 | | | | | | | | | | | | | | | | | | | | | | | | | | | | | | | | | | | | | |
| TVA | Time 2 | 00 | | | | | | | | | | | | | | | | | | | | | | | | | | | | | | | | | | | | | |
| | Time 3 | 00 | | | | | | | | | | | | | | | | | | | | | | | | | | | | | | | | | | | | | |
| | Level 2 | 00 | | | | | | | | | | | | | | | | | | | | | | | | | | | | | | | | | | | | | |
| | Sus level | 90 | | | | | | | | | | | | | | | | | | | | | | | | | | | | | | | | | | | | | |
| TVA | Time 4 | 00 | | | | | | | | | | | | | | | | | | | | | | | | | | | | | | | | | | | | | |
| | Level 2 | 90 | | | | | | | | | | | | | | | | | | | | | | | | | | | | | | | | | | | | | |
| | Time 1 | 37 | | | | | | | | | | | | | | | | | | | | | | | | | | | | | | | | | | | | | |
| | Level 1 | 100 | | | | | | | | | | | | | | | | | | | | | | | | | | | | | | | | | | | | | |

● Wind instruments

Here's how to simulate wind instruments such as flute or sax.

- ① Wind-type sounds (flute, sax, etc.) consist of the sustain component and the breath component. For the sustain component, use #092:Flute Tone. For the breath component, use #075:Flute Push (or #024:Rad Hose).
- ② Select LPF for the filter, and set a high cutoff frequency.
- ③ Make TVF/TVA envelope settings for each Tone as follows.

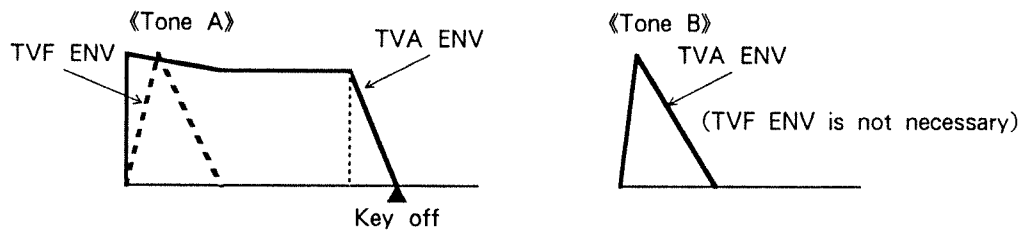

- ④ Using the LFO to create fade-in vibrato will make the sound more realistic.
- ⑤ Use the EQ to cut the obtrusive mid-range, and slightly boost the high range.
- ⑥ It is best to use the Chorus effect lightly.
- ⑦ For Reverb, select a hall-type effect and set a fairly long Time.
- ⑧ When playing this sound, turn Solo on, and turn Solo Legato off. It is also effective to use an external wind controller etc. to play this sound.

【Sample settings】

| PATCH COMMON | | | | | | | | | | PATCH EFFECTS | | | | | | | | | |
|----------------|--|-------------|--|-------------|------------|-------------|--|-------------------------------------|--|--|--|--------|----------------|------------------------------------|---------------------|--|--|--|--|
| Patch Name | | | | | Patch Name | | | | | Group A sequence/SW | | | | | Group B Sequence/SW | | | | |
| - | | | | | Flute | | | | | OFF → OFF → OFF → OFF | | | | | CH → RV → OFF | | | | |
| Level | | Bender | | Atouch | | Solo | | Portamento | | Distortion | | | | | Phaser | | | | |
| 100 | | 02 02 | | 00 | | ON OFF | | OFF | | | | | | | | | | | |
| Key Range | | | | | | | | | | Spectrum | | | | | Enhancer | | | | |
| Tone A | | Tone B | | Tone C | | Tone D | | Band1 Band2 Band3 Band4 Band5 Band6 | | | | | Width Sens Mix | | | | | | |
| Low High | | Low High | | Low High | | Low High | | | | | | | | | | | | | |
| C-1 G9 | | | | | | | | | | | | | | | | | | | |
| EQ | | | | | | | | | | Dry/Effect Balance B | | | | | Chorus | | | | |
| L-freq | | L-gain | | M-freq | | Mid-Q | | M-gain | | H-freq | | H-gain | | Rate Depth D-time Feedback Level | | | | | |
| 400Hz | | 00dB | | 630Hz | | 1.0 | | -05dB | | 4kHz | | +04dB | | D: 69 E: 31 0.4Hz 36 32.0ms 00% 63 | | | | | |
| MIDI Tx | | | | | | | | | | C-tap C-level L-tap L-level R-tap R-level Feedback | | | | | Delay | | | | |
| Mode | | Split Point | | Channel | | Prog change | | Hold mode | | ms ms ms ms ms | | | | | % | | | | |
| | | | | Lower Upper | | Lower Upper | | | | | | | | | | | | | |
| TONES | | | | | | | | | | Type Pre dly ER level HF damp Time Level | | | | | Reverb | | | | |
| A | | B | | C | | D | | HALL2 00ms 52 2kHz 3.6s 77 | | | | | | | | | | | |
| Layer | | ON ON | | OFF OFF | | | | | | | | | | | | | | | |
| Active | | ON OFF | | | | | | | | | | | | | | | | | |
| Hold control | | ON OFF | | | | | | | | | | | | | | | | | |
| Velo curve | | 03 04 | | | | | | | | | | | | | | | | | |
| Rate | | 76 | | | | | | | | | | | | | | | | | |
| Delay | | 47 | | | | | | | | | | | | | | | | | |
| Fade | | +28 | | | | | | | | | | | | | | | | | |
| Waveform | | TRI | | | | | | | | | | | | | | | | | |
| Offset | | 0 | | | | | | | | | | | | | | | | | |
| Key trigger | | ON | | | | | | | | | | | | | | | | | |
| Rate | | | | | | | | | | | | | | | | | | | |
| Delay | | | | | | | | | | | | | | | | | | | |
| Fade | | | | | | | | | | | | | | | | | | | |
| Waveform | | | | | | | | | | | | | | | | | | | |
| Offset | | | | | | | | | | | | | | | | | | | |
| Key trigger | | | | | | | | | | | | | | | | | | | |
| Pitch coarse | | +12 +12 | | | | | | | | | | | | | | | | | |
| Pitch fine | | 00 00 | | | | | | | | | | | | | | | | | |
| Pitch randam | | 00 00 | | | | | | | | | | | | | | | | | |
| Pitch KF | | 100 101 | | | | | | | | | | | | | | | | | |
| Atouch bend | | OFF OFF | | | | | | | | | | | | | | | | | |
| Bender | | ON ON | | | | | | | | | | | | | | | | | |
| Waveform | | 092 075 | | | | | | | | | | | | | | | | | |
| Wave source | | INT INT | | | | | | | | | | | | | | | | | |
| Atouch sens | | 00 00 | | | | | | | | | | | | | | | | | |
| LFO 1 depth | | +10 00 | | | | | | | | | | | | | | | | | |
| LFO 2 depth | | 00 00 | | | | | | | | | | | | | | | | | |
| Lever sens | | 35 00 | | | | | | | | | | | | | | | | | |
| Velo sens | | 00 00 | | | | | | | | | | | | | | | | | |
| Time velo | | 00 00 | | | | | | | | | | | | | | | | | |
| Time KF | | 00 00 | | | | | | | | | | | | | | | | | |
| Level 0 | | 00 00 | | | | | | | | | | | | | | | | | |
| Time 1 | | 00 00 | | | | | | | | | | | | | | | | | |
| Level 1 | | 00 00 | | | | | | | | | | | | | | | | | |
| Time 2 | | 00 00 | | | | | | | | | | | | | | | | | |
| Time 3 | | 00 00 | | | | | | | | | | | | | | | | | |
| Level 2 | | 00 00 | | | | | | | | | | | | | | | | | |
| LFO 1 COM | | | | | | | | | | TVF | | | | | TVF ENV | | | | |
| Filter mode | | LPF LPF | | | | | | | | | | | | | | | | | |
| Cutoff freq | | 66 70 | | | | | | | | | | | | | | | | | |
| Resonance | | 00 00 | | | | | | | | | | | | | | | | | |
| ENV depth | | +16 00 | | | | | | | | | | | | | | | | | |
| Cutoff KF | | 50 40 | | | | | | | | | | | | | | | | | |
| LFO select | | [] [] | | | | | | | | | | | | | | | | | |
| LFO depth | | 00 00 | | | | | | | | | | | | | | | | | |
| Atouch sens | | 00 00 | | | | | | | | | | | | | | | | | |
| LFO 2 | | | | | | | | | | TVA | | | | | TVA ENV | | | | |
| Velo sens | | +20 | | | | | | | | | | | | | | | | | |
| Time velo | | 00 | | | | | | | | | | | | | | | | | |
| Time KF | | 00 | | | | | | | | | | | | | | | | | |
| Time 1 | | 31 | | | | | | | | | | | | | | | | | |
| Level 1 | | 100 | | | | | | | | | | | | | | | | | |
| Time 2 | | 49 | | | | | | | | | | | | | | | | | |
| Level 2 | | 00 | | | | | | | | | | | | | | | | | |
| Time 3 | | 00 | | | | | | | | | | | | | | | | | |
| Sus level | | 00 | | | | | | | | | | | | | | | | | |
| Time 4 | | 00 | | | | | | | | | | | | | | | | | |
| Level 4 | | 00 | | | | | | | | | | | | | | | | | |
| Level | | 100 100 | | | | | | | | | | | | | | | | | |
| Bias direction | | UP UP | | | | | | | | | | | | | | | | | |
| Bias point | | C4 C4 | | | | | | | | | | | | | | | | | |
| Bias level | | 00 00 | | | | | | | | | | | | | | | | | |
| Atouch sens | | 00 00 | | | | | | | | | | | | | | | | | |
| LFO select | | [] [] | | | | | | | | | | | | | | | | | |
| LFO depth | | 00 00 | | | | | | | | | | | | | | | | | |
| Velo sens | | +34 +44 | | | | | | | | | | | | | | | | | |
| Time velo | | 00 -18 | | | | | | | | | | | | | | | | | |
| Time KF | | +05 +04 | | | | | | | | | | | | | | | | | |
| Time 1 | | 20 17 | | | | | | | | | | | | | | | | | |
| Level 1 | | 100 100 | | | | | | | | | | | | | | | | | |
| Time 2 | | 53 65 | | | | | | | | | | | | | | | | | |
| Level 2 | | 97 00 | | | | | | | | | | | | | | | | | |
| Time 3 | | 00 00 | | | | | | | | | | | | | | | | | |
| Sus level | | 97 00 | | | | | | | | | | | | | | | | | |
| Time 4 | | 41 16 | | | | | | | | | | | | | | | | | |

● Synth voice

This is a typical airy synth sound.

① Select wave #025 for Tone A, and #035 for Tone B.

② Make TVA/TVF settings for each Tone as follows.

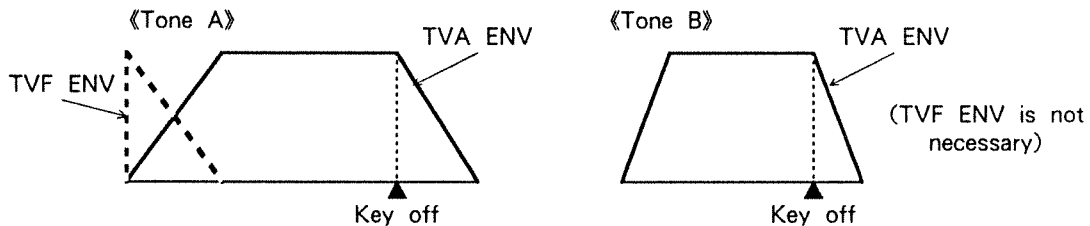

③ For Tone B, use the filter in BPF mode, and slightly raise the Resonance.

④ Make LFO1 and Depth settings to apply different vibrato to each Tone.

⑤ For Tone B, set the LFO2 to be applied after key off.

⑥ For Tone A, apply the pitch envelope to make the pitch unsteady during the attack. Make settings to allow aftertouch to affect the tone.

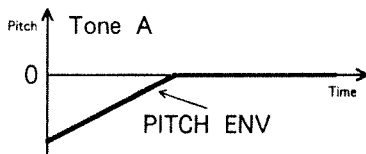

⑦ Taking into account the overall balance, use the EQ to slightly boost the mid range.

⑧ Apply Chorus to thicken the sound.

⑨ For Reverb, select a Hall-type effect, and set a fairly long Time to create depth.

⑩ When playing this sound, use velocity to cross-fade between Tone A and Tone B.

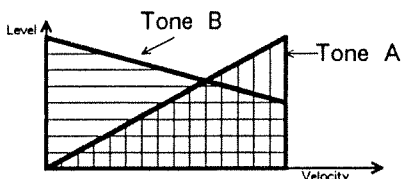

[Sample settings]

| PATCH COMMON | | | | | | | | | | PATCH EFFECTS | | | | | | | | | |
|--------------|--------------|---------|------------------|-------------|------------|----------------|-------------|------|------------|---------------------------------------|-------|-------------|---------|--------|---------------------|-------|-----|--|--|
| Patch Name | | | | | Patch Name | | | | | Group A sequence/SW | | | | | Group B Sequence/SW | | | | |
| Syn voice | | | | | | | | | | OFF → OFF → OFF → OFF → CH → RV → OFF | | | | | | | | | |
| Level | Bender | | Atouch bend sens | Solo | | Portamento | | | Distortion | | | | | Phaser | | | | | |
| | Down | Up | | SW | Legato | SW | Mode | Time | Type | Drive | Level | Manual | Rate | Depth | Reso | Mix | | | |
| 100 | 02 | 02 | 00 | OFF | | OFF | | | | | | Hz | Hz | | | | | | |
| Key Range | | | | | | | | | | Spectrum | | | | | Enhancer | | | | |
| Tone A | | Tone B | | Tone C | | Tone D | | | Band1 | Band2 | Band3 | Band4 | Band5 | Band6 | Width | Sens | Mix | | |
| Low | High | Low | High | Low | High | Low | High | | | | | | | | | | | | |
| C-1 | G9 | C-1 | G9 | | | | | | | | | | | | | | | | |
| EQ | | | | | | | | | | Dry/Effect Balance B | | | | | Chorus | | | | |
| L-freq | L-gain | M-freq | Mid-Q | M-gain | H-freq | H-gain | | | | D: 18 | E: 82 | Rate | Depth | D-time | Feedback | Level | | | |
| 400Hz | 00dB | 1kHz | 1.0 | +05dB | 4kHz | 00dB | | | | | | 1.1Hz | 22 | 0.1ms | 00% | 74 | | | |
| MIDI Tx | | | | | | | | | | C-tap | | | | | L-tap | | | | |
| Mode | Split Point | Channel | | Prog change | | Hold mode | ms | | ms | | ms | | ms | | % | | | | |
| | | Lower | Upper | Lower | Upper | | | | | | | | | | | | | | |
| TONES | | | | | | | | | | Type | | | | | Pre dly | | | | |
| | | | | | | | | | | HALL2 | 100ms | ER level | HF damp | Time | Level | | | | |
| | | | | | | | | | | | | 73 | 10kHz | 3.2s | 78 | | | | |
| Layer | | A | B | C | D | TONES | | A | B | C | D | Filter mode | | | | | | | |
| | | ON | ON | OFF | OFF | | | LPF | BPF | | | | | | | | | | |
| COM | Active | ON | ON | | | TVF | Filter mode | LPF | BPF | | | | | | | | | | |
| | Hold control | ON | ON | | | | Cutoff freq | 55 | 52 | | | | | | | | | | |
| | Velo curve | 02 | 03 | | | | Resonance | 00 | 35 | | | | | | | | | | |
| LFO 1 | Rate | 74 | 65 | | | ENV depth | +24 | 00 | | | | | | | | | | | |
| | Delay | 00 | 00 | | | Cutoff KF | 35 | 50 | | | | | | | | | | | |
| | Fade | 00 | +08 | | | LFO select | █ | █ | | | | | | | | | | | |
| | Waveform | TRI | TRI | | | LFO depth | 00 | 00 | | | | | | | | | | | |
| LFO 2 | Offset | 0 | 0 | | | Atouch sens | +11 | 00 | | | | | | | | | | | |
| | Key trigger | ON | ON | | | Velo sens | +50 | | | | | | | | | | | | |
| | Rate | | 82 | | | Time velo | 00 | | | | | | | | | | | | |
| | Delay | | REL | | | Time KF | 00 | | | | | | | | | | | | |
| WG | Fade | | +29 | | | Time 1 | 00 | | | | | | | | | | | | |
| | Waveform | | SQU | | | Level 1 | 100 | | | | | | | | | | | | |
| | Offset | | 0 | | | Time 2 | 87 | | | | | | | | | | | | |
| | Key trigger | | ON | | | Level 2 | 00 | | | | | | | | | | | | |
| PITCH ENV | Pitch coarse | 00 | 00 | | | Time 3 | 00 | | | | | | | | | | | | |
| | Pitch fine | 00 | 00 | | | Sus level | 00 | | | | | | | | | | | | |
| | Pitch randam | 10 | 20 | | | Time 4 | 76 | | | | | | | | | | | | |
| | Pitch KF | 100 | 100 | | | Level 4 | 00 | | | | | | | | | | | | |
| TVF ENV | Atouch bend | OFF | OFF | | | Level | 100 | 86 | | | | | | | | | | | |
| | Bender | ON | ON | | | Bias direction | UP | UP | | | | | | | | | | | |
| | Waveform | 025 | 035 | | | Bias point | C4 | C4 | | | | | | | | | | | |
| | Wave source | INT | INT | | | Bias level | 00 | 00 | | | | | | | | | | | |
| TVA | Atouch sens | 00 | 00 | | | Atouch sens | 00 | 00 | | | | | | | | | | | |
| | LFO 1 depth | +10 | +10 | | | LFO select | █ | █ | | | | | | | | | | | |
| | LFO 2 depth | 00 | +50 | | | LFO depth | 00 | 00 | | | | | | | | | | | |
| | Lever sens | █24 | 00 | | | Velo sens | +32 | -20 | | | | | | | | | | | |
| TVA ENV | Velo sens | +26 | 00 | | | Time velo | +50 | 00 | | | | | | | | | | | |
| | Time velo | +08 | 00 | | | Time KF | +02 | +01 | | | | | | | | | | | |
| | Time KF | +05 | 00 | | | Time 1 | 79 | 47 | | | | | | | | | | | |
| | Level 0 | -22 | 00 | | | Level 1 | 100 | 100 | | | | | | | | | | | |
| TVA ENV | Time 1 | 47 | 00 | | | Time 2 | 00 | 00 | | | | | | | | | | | |
| | Level 1 | 00 | 00 | | | Level 2 | 100 | 100 | | | | | | | | | | | |
| | Time 2 | 00 | 00 | | | Time 3 | 00 | 00 | | | | | | | | | | | |
| | Time 3 | 00 | 00 | | | Sus level | 100 | 100 | | | | | | | | | | | |
| Level 2 | 00 | 00 | | | Time 4 | 77 | 64 | | | | | | | | | | | | |

● Synth bass

- ① Use Tone A to create the core of the sound, and Tone B to emphasize the attack.
- ② Make TVA/TVF envelope settings for each Tone as follows. Since the Tone B TVF envelope has an ENV Depth setting of -50 , the actual envelope will be different.

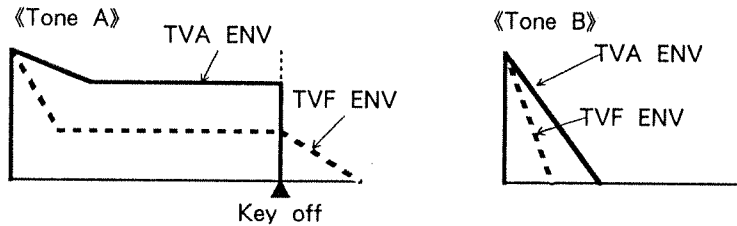

- ③ Use the filter in LPF mode. Higher settings of Resonance will create a more distinctive sound character.
- ④ Since bass is a low-range instrument, set the Pitch Coarse to -24 .
- ⑤ Select waves #23:Syn Bass and #032:Wave Scan. Other possibilities are sawtooth waves #001 — 003.
- ⑥ Use the EQ to boost the low range.
- ⑦ Set the Reverb Type to GATE.
- ⑧ When playing this sound, use Solo/Portamento. It is usually more effective for synth bass sounds to have a clear attack, so turn off Solo Legato, and set the Portamento mode to normal.
- ⑨ Set the Bender Range to ± 1 octave. Set vibrato to be applied only when the Modulation lever is moved.

[Sample settings]

| PATCH COMMON | | | | | | | | | | PATCH EFFECTS | | | | | | | | | | | | | |
|--------------|--|---------------|--|--------------|------------|------------------|--|---------------------------|-------|--|-------|---------|----------------------------------|-------------|---------------------|---------|-----|-------|--|---------|--|----------|--|
| Patch Name | | | | | Patch Name | | | | | Group A sequence/SW | | | | | Group B Sequence/SW | | | | | | | | |
| Syn. Bass | | | | | | | | | | OFF → OFF → OFF → OFF → RV → OFF → OFF | | | | | | | | | | | | | |
| Level | | Bender | | Atouch | | Solo | | Portamento | | Distortion | | | | | Phaser | | | | | | | | |
| 100 | | Down 12 Up 12 | | bend sens 00 | | SW Legato ON OFF | | SW Mode Time ON NORMAL 37 | | Type | Drive | Level | Manual | Rate | Depth | Reso | Mix | | | | | | |
| Key Range | | | | | | | | | | Spectrum | | | | | Enhancer | | | | | | | | |
| Tone A | | Tone B | | Tone C | | Tone D | | Band1 | Band2 | Band3 | Band4 | Band5 | Band6 | Width | Sens | Mix | | | | | | | |
| Low High | | Low High | | Low High | | Low High | | | | | | | | | | | | | | | | | |
| C-1 G9 | | C-1 G9 | | | | | | Dry/Effect | | | | | Chorus | | | | | | | | | | |
| | | | | | | | | Balance B | | | | | Rate Depth D-time Feedback Level | | | | | | | | | | |
| L-freq | | L-gain | | M-freq | | Mid-Q | | M-gain | | H-freq | | H-gain | | D: 68 E: 32 | | | | | | | | | |
| 400Hz | | +03dB | | 1kHz | | 0.5 | | 00dB | | 4kHz | | 00dB | | | | | | | | | | | |
| MIDI Tx | | | | | | | | | | C-tap | | C-level | | L-tap | | L-level | | R-tap | | R-level | | Feedback | |
| Mode | | Split Point | | Channel | | Prog change | | Hold mode | | ms | | ms | | ms | | ms | | % | | % | | | |
| | | | | Lower Upper | | Lower Upper | | | | | | | | | | | | | | | | | |
| TONES | | | | | | | | | | Type | | Pre dly | | ER level | | HF damp | | Time | | Level | | | |
| Layer | | A | | B | | C | | D | | GATE | | 00ms | | Hz | | 100ms | | 34 | | | | | |
| Active | | ON | | ON | | OFF | | OFF | | | | | | | | | | | | | | | |
| Hold control | | ON | | OFF | | | | | | TONES | | A | | B | | C | | D | | | | | |
| Velo curve | | 02 | | 04 | | | | | | Filter mode | | LPF | | LPF | | | | | | | | | |
| Rate | | 83 | | | | | | | | Cutoff freq | | 71 | | 98 | | | | | | | | | |
| Delay | | 00 | | | | | | | | Resonance | | 31 | | 27 | | | | | | | | | |
| Fade | | 00 | | | | | | | | ENV depth | | +18 | | -50 | | | | | | | | | |
| Waveform | | TRI | | | | | | | | Cutoff KF | | 70 | | 80 | | | | | | | | | |
| Offset | | 0 | | | | | | | | LFO select | | II | | II | | | | | | | | | |
| Key trigger | | ON | | | | | | | | LFO depth | | 00 | | 00 | | | | | | | | | |
| Rate | | | | | | | | | | Atouch sens | | 00 | | 00 | | | | | | | | | |
| Delay | | | | | | | | | | Velo sens | | +20 | | 00 | | | | | | | | | |
| Fade | | | | | | | | | | Time velo | | +14 | | 00 | | | | | | | | | |
| Waveform | | | | | | | | | | Time KF | | 00 | | 00 | | | | | | | | | |
| Offset | | | | | | | | | | Time 1 | | 00 | | 37 | | | | | | | | | |
| Key trigger | | | | | | | | | | Level 1 | | 100 | | 100 | | | | | | | | | |
| Pitch coarse | | -24 | | -24 | | | | | | Time 2 | | 27 | | 00 | | | | | | | | | |
| Pitch fine | | 00 | | 00 | | | | | | Level 2 | | 39 | | 100 | | | | | | | | | |
| Pitch random | | 00 | | 00 | | | | | | Time 3 | | 00 | | 00 | | | | | | | | | |
| Pitch KF | | 100 | | 100 | | | | | | Sus level | | 39 | | 100 | | | | | | | | | |
| Atouch bend | | OFF | | OFF | | | | | | Time 4 | | 65 | | 00 | | | | | | | | | |
| Bender | | ON | | OFF | | | | | | Level 4 | | 00 | | 00 | | | | | | | | | |
| Waveform | | 023 | | 032 | | | | | | Level | | 100 | | 100 | | | | | | | | | |
| Wave source | | INT | | INT | | | | | | Bias direction | | UP | | UP | | | | | | | | | |
| Atouch sens | | 00 | | 00 | | | | | | Bias point | | C4 | | C4 | | | | | | | | | |
| LFO 1 depth | | 00 | | 00 | | | | | | Bias level | | 00 | | 00 | | | | | | | | | |
| LFO 2 depth | | 00 | | 00 | | | | | | Atouch sens | | 00 | | 00 | | | | | | | | | |
| Lever sens | | 40 | | 00 | | | | | | LFO select | | II | | II | | | | | | | | | |
| Velo sens | | 00 | | 00 | | | | | | LFO depth | | 00 | | 00 | | | | | | | | | |
| Time velo | | 00 | | 00 | | | | | | Velo sens | | +25 | | +31 | | | | | | | | | |
| Time KF | | 00 | | 00 | | | | | | Time velo | | 00 | | +16 | | | | | | | | | |
| Level 0 | | 00 | | 00 | | | | | | Time KF | | 00 | | +03 | | | | | | | | | |
| Time 1 | | 00 | | 00 | | | | | | Time 1 | | 00 | | 00 | | | | | | | | | |
| Level 1 | | 00 | | 00 | | | | | | Level 1 | | 100 | | 00 | | | | | | | | | |
| Time 2 | | 00 | | 00 | | | | | | Time 2 | | 67 | | 67 | | | | | | | | | |
| Time 3 | | 00 | | 00 | | | | | | Level 2 | | 72 | | 00 | | | | | | | | | |
| Level 2 | | 00 | | 00 | | | | | | Time 3 | | 00 | | 00 | | | | | | | | | |
| | | | | | | | | | | Sus level | | 72 | | 00 | | | | | | | | | |
| | | | | | | | | | | Time 4 | | 10 | | 10 | | | | | | | | | |

● Electric organ

Organs can be created by adding sine waves.

- ① Select a wave for #012:Syn Sine. Waves such as #040 and #041 are also suitable for organ sounds.
- ② Set "square" TVA envelopes for Tones A—C. Use Tone D to create the attack.

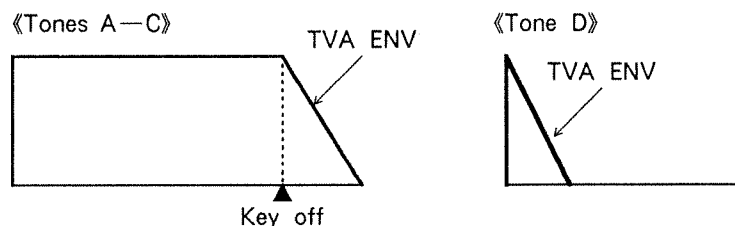

- ③ Layer identical tones, with the Pitch Coarse of each Tone set a fifth apart (+7 or +19).
- ④ Apply a slow-rate LFO only to Tone A. The pitch will periodically diverge from Tone B, creating modulation.
- ⑤ Use Chorus and Reverb effects.
- ⑥ For the Chorus, set a slow Rate and high Depth/Delay to spread the sound widely to left and right.
- ⑦ For the Reverb, select ROOM2 as the Type, and set a fairly short Time.
- ⑧ While playing, you can use the Palette to adjust the TVA level in the same way as operating the drawbars of an organ.
- ⑨ By selecting wave #042 and setting the TVA ENV T1 to about 50, you can also create pipe organ-type sounds.

[Sample settings]

| PATCH COMMON | | | | | | | | | | PATCH EFFECTS | | | | | | | | | |
|--------------|--------------|---------|-----------|-------------|------------|----------------|------------|----------|-------------|-----------------------|-------|---------|----------|-------|---------------------|----------|-----|--|--|
| Patch Name | | | | | Patch Name | | | | | Group A sequence/SW | | | | | Group B Sequence/SW | | | | |
| - | | | | | E. Organ | | | | | OFF → OFF → OFF → OFF | | | | | CH → RV → OFF | | | | |
| Level | Bender | | Atouch | | Solo | | Portamento | | | Distortion | | | | | Phaser | | | | |
| | Down | Up | bend sens | | SW | Legato | SW | Mode | Time | Type | Drive | Level | Manual | Rate | Depth | Reso | Mix | | |
| 100 | 02 | 02 | 00 | | off | | off | | | | | Hz | Hz | Hz | | | | | |
| Key Range | | | | | | | | | | Spectrum | | | | | | Enhancer | | | |
| Tone A | | Tone B | | Tone C | | Tone D | | Band1 | Band2 | Band3 | Band4 | Band5 | Band6 | Width | Sens | Mix | | | |
| Low | High | Low | High | Low | High | Low | High | | | | | | | | | | | | |
| C-1 | G9 | C-1 | G9 | C-1 | G9 | C-1 | G9 | | | | | | | | | | | | |
| EQ | | | | | | | | | | Dry/Effect | | Chorus | | | | | | | |
| L-freq | L-gain | M-freq | Mid-Q | M-gain | H-freq | H-gain | | | Balance B | Rate | Depth | D-time | Feedback | Level | | | | | |
| Hz | dB | Hz | | dB | Hz | dB | | | D: 18 E: 82 | 0.8Hz | 26 | 26.0ms | + 30% | 100 | | | | | |
| MIDI Tx | | | | | | | | | | Delay | | Reverb | | | | | | | |
| Mode | Split Point | Channel | | Prog change | | Hold mode | C-tap | C-level | L-tap | L-level | R-tap | R-level | Feedback | | | | | | |
| | | Lower | Upper | Lower | Upper | | ms | | ms | | ms | | % | | | | | | |
| TONES | | A | B | C | D | Type | Pre dly | ER level | HF damp | Time | Level | | | | | | | | |
| Layer | ON | ON | ON | ON | ON | ROOM2 | 21ms | 00 | 10kHz | 0.5s | 25 | | | | | | | | |
| Active | ON | ON | ON | ON | ON | TONES | | A | B | C | D | | | | | | | | |
| COM | Hold control | ON | ON | ON | ON | Filter mode | LPF | LPF | LPF | LPF | | | | | | | | | |
| | Velo curve | 03 | 03 | 03 | 03 | Cutoff freq | 100 | 65 | 65 | 100 | | | | | | | | | |
| LFO 1 | Rate | 73 | 73 | 73 | 73 | Resonance | 00 | 00 | 00 | 00 | | | | | | | | | |
| | Delay | 00 | 00 | 00 | 00 | ENV depth | 00 | 00 | 00 | 00 | | | | | | | | | |
| | Fade | 00 | 00 | 00 | 00 | Cutoff KF | 45 | 45 | 45 | 45 | | | | | | | | | |
| | Waveform | TRI | TRI | TRI | TRI | LFO select | ■ | ■ | ■ | ■ | | | | | | | | | |
| | Offset | 0 | 0 | 0 | 0 | LFO depth | 00 | 00 | 00 | 00 | | | | | | | | | |
| LFO 2 | Key trigger | ON | ON | ON | ON | Atouch sens | 00 | 00 | 00 | 00 | | | | | | | | | |
| | Rate | 15 | | | | Velo sens | | | | | | | | | | | | | |
| | Delay | 00 | | | | Time velo | | | | | | | | | | | | | |
| | Fade | 00 | | | | Time KF | | | | | | | | | | | | | |
| | Waveform | TRI | | | | Time 1 | | | | | | | | | | | | | |
| WG | Offset | 0 | | | | Level 1 | | | | | | | | | | | | | |
| | Key trigger | ON | | | | Time 2 | | | | | | | | | | | | | |
| | Pitch coarse | 00 | 00 | + 07 | + 19 | Level 2 | | | | | | | | | | | | | |
| | Pitch fine | 00 | 00 | 00 | 00 | Time 3 | | | | | | | | | | | | | |
| | Pitch randam | 00 | 00 | 00 | 00 | Sus level | | | | | | | | | | | | | |
| PITCH ENV | Pitch KF | 100 | 100 | 100 | 100 | Time 4 | | | | | | | | | | | | | |
| | Atouch bend | OFF | OFF | OFF | OFF | Level 4 | | | | | | | | | | | | | |
| | Bender | ON | ON | ON | ON | Level | 100 | 95 | 70 | 100 | | | | | | | | | |
| | Waveform | 012 | 012 | 012 | 012 | Bias direction | UP | UP | UP | UP | | | | | | | | | |
| | Wave source | INT | INT | INT | INT | Bias point | C4 | C4 | C4 | C4 | | | | | | | | | |
| TVA | Atouch sens | 00 | 00 | 00 | 00 | Bias level | 00 | 00 | 00 | 00 | | | | | | | | | |
| | LFO 1 depth | 00 | 00 | 00 | 00 | Atouch sens | 00 | 00 | 00 | 00 | | | | | | | | | |
| | LFO 2 depth | + 19 | 00 | 00 | 00 | LFO select | ■ | ■ | ■ | ■ | | | | | | | | | |
| | Lever sens | ■27 | ■27 | ■27 | ■27 | LFO depth | 00 | 00 | 00 | 00 | | | | | | | | | |
| | Velo sens | 00 | 00 | 00 | 00 | Velo sens | + 30 | + 30 | + 30 | + 30 | | | | | | | | | |
| TVA ENV | Time velo | 00 | 00 | 00 | 00 | Time velo | 00 | 00 | 00 | 00 | | | | | | | | | |
| | Time KF | 00 | 00 | 00 | 00 | Time KF | 00 | 00 | 00 | 00 | | | | | | | | | |
| | Level 0 | 00 | 00 | 00 | 00 | Time 1 | 00 | 00 | 00 | 00 | | | | | | | | | |
| | Time 1 | 00 | 00 | 00 | 00 | Level 1 | 100 | 100 | 100 | 100 | | | | | | | | | |
| | Level 1 | 00 | 00 | 00 | 00 | Time 2 | 00 | 00 | 00 | 50 | | | | | | | | | |
| TVA ENV | Time 2 | 00 | 00 | 00 | 00 | Level 2 | 100 | 100 | 100 | 00 | | | | | | | | | |
| | Time 3 | 00 | 00 | 00 | 00 | Time 3 | 00 | 00 | 00 | 00 | | | | | | | | | |
| | Level 2 | 00 | 00 | 00 | 00 | Sus level | 100 | 100 | 100 | 00 | | | | | | | | | |
| | Time 4 | 00 | 00 | 00 | 00 | Time 4 | 04 | 04 | 04 | 04 | | | | | | | | | |

● Acoustic piano

- ① Use #071:Piano Atk as the wave.
- ② Set the Pitch Key Follow to 101. This will make the pitch slightly higher in the high range and slightly lower in the low range (i.e., stretched tuning).
- ③ Create a decay-type TVF envelope, and set the ENV Depth to about +40. Make Velocity Sensitivity and Time Velocity settings so that for low velocities (softly played notes) the filter will not open very much.

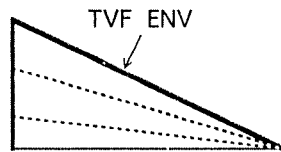

- ④ Create a decay-type envelope for the TVA as well. Make Velocity Sensitivity, Time Velocity, and Time Key Follow settings to simulate the characteristics of a piano.

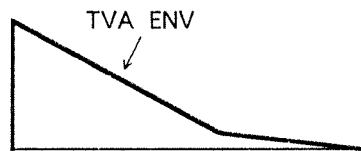

- ⑤ For a piano, use only one Tone in order to provide as many simultaneous notes as possible. For a honky-tonk piano, detune two identical Tones (Pitch Fine = about ± 5).
- ⑥ Use effects EQ/Chorus/Reverb.
- ⑦ Use the EQ to boost the mid-range to increase the perceived volume.
- ⑧ Select a Reverb type appropriate for the location in which the piano will be played. For a solo piano, select a hall-type reverb. For a backing piano, select a room-type reverb.
- ⑨ Use Chorus to broaden the sound to left and right.
- ⑩ When playing this sound, use velocity to control the dynamics of the sound. Connecting a Hold pedal will allow more piano-like performance.

[Sample settings]

| PATCH COMMON | | | | | | | | | | PATCH EFFECTS | | | | | | | | | |
|--------------|-------------|---------|-----------|-------------|------------|-----------|-------------|------|-------|-----------------------|---------|----------|---------|---------|---------------------|------|-----|--|--|
| Patch Name | | | | | Patch Name | | | | | Group A sequence/SW | | | | | Group B Sequence/SW | | | | |
| - | | | | | A. Piano | | | | | OFF → OFF → OFF → OFF | | | | | CH → RV → OFF | | | | |
| Level | Bender | | Atouch | | Solo | | Portamento | | | Distortion | | | | | Phaser | | | | |
| | Down | Up | bend sens | | SW | Legato | SW | Mode | Time | Type | Drive | Level | Manual | Rate | Depth | Reso | Mix | | |
| 100 | 00 | 0C | 00 | | OFF | | OFF | | | | | | Hz | Hz | | | | | |
| Key Range | | | | | | | | | | Spectrum | | | | | Enhancer | | | | |
| Tone A | | Tone B | | Tone C | | Tone D | | | Band1 | Band2 | Band3 | Band4 | Band5 | Band6 | Width | Sens | Mix | | |
| Low | High | Low | High | Low | High | Low | High | | | | | | | | | | | | |
| C-1 | G9 | | | | | | | | | | | | | | | | | | |
| EQ | | | | | | | | | | Dry/Effect | | Chorus | | | | | | | |
| L-freq | L-gain | M-freq | Mid-Q | M-gain | H-freq | H-gain | D: 67 E: 33 | | Rate | Depth | D-time | Feedback | Level | | | | | | |
| 400Hz | 00dB | 1kHz | 0.5 | +13dB | 4kHz | 00dB | | | 0.1Hz | 29 | 50.0ms | 00% | 100 | | | | | | |
| MIDI Tx | | | | | | | | | | Delay | | | | | | | | | |
| Mode | Split Point | Channel | | Prog change | | Hold mode | | | C-tap | C-level | L-tap | L-level | R-tap | R-level | Feedback | | | | |
| | | Lower | Upper | Lower | Upper | | | | ms | | ms | | ms | | % | | | | |
| | | | | | | | | | | Reverb | | | | | | | | | |
| | | | | | | | | | | Type | Pre dly | ER level | HF damp | Time | Level | | | | |
| | | | | | | | | | | hall3 | 00ms | 93 | 1.6kHz | 1.8s | 85 | | | | |
| TONES | | | | | | | | | | TONES | | | | | | | | | |
| | | A | | B | | C | | D | | A | | B | | C | | D | | | |
| Layer | | ON | | OFF | | OFF | | OFF | | | | | | | | | | | |
| Active | | ON | | | | | | | | | | | | | | | | | |
| Hold control | | ON | | | | | | | | | | | | | | | | | |
| Velo curve | | 04 | | | | | | | | | | | | | | | | | |
| Rate | | | | | | | | | | | | | | | | | | | |
| Delay | | | | | | | | | | | | | | | | | | | |
| Fade | | | | | | | | | | | | | | | | | | | |
| Waveform | | | | | | | | | | | | | | | | | | | |
| Offset | | | | | | | | | | | | | | | | | | | |
| Key trigger | | | | | | | | | | | | | | | | | | | |
| Rate | | | | | | | | | | | | | | | | | | | |
| Delay | | | | | | | | | | | | | | | | | | | |
| Fade | | | | | | | | | | | | | | | | | | | |
| Waveform | | | | | | | | | | | | | | | | | | | |
| Offset | | | | | | | | | | | | | | | | | | | |
| Key trigger | | | | | | | | | | | | | | | | | | | |
| Pitch coarse | | 00 | | | | | | | | | | | | | | | | | |
| Pitch fine | | 00 | | | | | | | | | | | | | | | | | |
| Pitch randam | | 00 | | | | | | | | | | | | | | | | | |
| Pitch KF | | 101 | | | | | | | | | | | | | | | | | |
| Atouch bend | | OFF | | | | | | | | | | | | | | | | | |
| Bender | | OFF | | | | | | | | | | | | | | | | | |
| Waveform | | 071 | | | | | | | | | | | | | | | | | |
| Wave source | | INT | | | | | | | | | | | | | | | | | |
| Atouch sens | | 00 | | | | | | | | | | | | | | | | | |
| LFO 1 depth | | 00 | | | | | | | | | | | | | | | | | |
| LFO 2 depth | | 00 | | | | | | | | | | | | | | | | | |
| Lever sens | | 00 | | | | | | | | | | | | | | | | | |
| Velo sens | | 00 | | | | | | | | | | | | | | | | | |
| Time velo | | 00 | | | | | | | | | | | | | | | | | |
| Time KF | | 00 | | | | | | | | | | | | | | | | | |
| Level 0 | | 00 | | | | | | | | | | | | | | | | | |
| Time 1 | | 00 | | | | | | | | | | | | | | | | | |
| Level 1 | | 00 | | | | | | | | | | | | | | | | | |
| Time 2 | | 00 | | | | | | | | | | | | | | | | | |
| Time 3 | | 00 | | | | | | | | | | | | | | | | | |
| Level 2 | | 00 | | | | | | | | | | | | | | | | | |
| | | | | | | | | | | TVF | | | | | | | | | |
| | | | | | | | | | | Filter mode | LPF | | | | | | | | |
| | | | | | | | | | | Cutoff freq | 64 | | | | | | | | |
| | | | | | | | | | | Resonance | 00 | | | | | | | | |
| | | | | | | | | | | ENV depth | +37 | | | | | | | | |
| | | | | | | | | | | Cutoff KF | 60 | | | | | | | | |
| | | | | | | | | | | LFO select | I | | | | | | | | |
| | | | | | | | | | | LFO depth | 00 | | | | | | | | |
| | | | | | | | | | | Atouch sens | 00 | | | | | | | | |
| | | | | | | | | | | TVF ENV | | | | | | | | | |
| | | | | | | | | | | Velo sens | +45 | | | | | | | | |
| | | | | | | | | | | Time velo | +12 | | | | | | | | |
| | | | | | | | | | | Time KF | 00 | | | | | | | | |
| | | | | | | | | | | Time 1 | 00 | | | | | | | | |
| | | | | | | | | | | Level 1 | 100 | | | | | | | | |
| | | | | | | | | | | Time 2 | 69 | | | | | | | | |
| | | | | | | | | | | Level 2 | 00 | | | | | | | | |
| | | | | | | | | | | Time 3 | 00 | | | | | | | | |
| | | | | | | | | | | Sus level | 00 | | | | | | | | |
| | | | | | | | | | | Time 4 | 54 | | | | | | | | |
| | | | | | | | | | | Level 4 | 00 | | | | | | | | |
| | | | | | | | | | | TVA | | | | | | | | | |
| | | | | | | | | | | Level | 100 | | | | | | | | |
| | | | | | | | | | | Bias direction | UP | | | | | | | | |
| | | | | | | | | | | Bias point | C5 | | | | | | | | |
| | | | | | | | | | | Bias level | -03 | | | | | | | | |
| | | | | | | | | | | Atouch sens | 00 | | | | | | | | |
| | | | | | | | | | | LFO select | I | | | | | | | | |
| | | | | | | | | | | LFO depth | 00 | | | | | | | | |
| | | | | | | | | | | TVA ENV | | | | | | | | | |
| | | | | | | | | | | Velo sens | +47 | | | | | | | | |
| | | | | | | | | | | Time velo | -15 | | | | | | | | |
| | | | | | | | | | | Time KF | +04 | | | | | | | | |
| | | | | | | | | | | Time 1 | 00 | | | | | | | | |
| | | | | | | | | | | Level 1 | 100 | | | | | | | | |
| | | | | | | | | | | Time 2 | 77 | | | | | | | | |
| | | | | | | | | | | Level 2 | 05 | | | | | | | | |
| | | | | | | | | | | Time 3 | 38 | | | | | | | | |
| | | | | | | | | | | Sus level | 00 | | | | | | | | |
| | | | | | | | | | | Time 4 | 52 | | | | | | | | |

● Electric piano

Here's how to create a Rhodes-type piano.

① Select wave #072 for Tone A, and wave #074 for Tone B.

② Set the TVF/TVA envelopes for each Tone as follows.

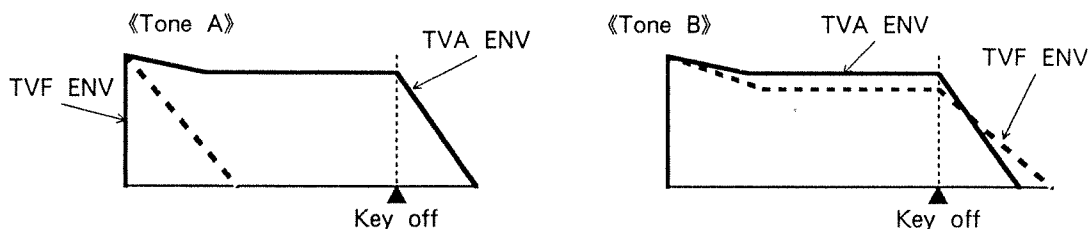

③ Make Velocity Sensitivity settings for the TVA envelope so that Tone B will be added to Tone A for strongly played notes.

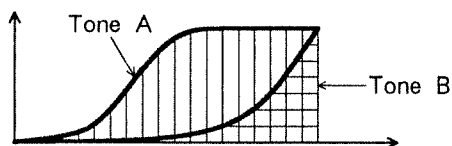

④ Use effects EQ/Phaser/Chorus/Reverb.

⑤ Use the EQ to slightly boost the low and high ranges.

⑥ Use the Phaser to create slow modulation, for a sound that was popular during the 1970's.

⑦ Use the Enhancer to create a metallic sound.

⑧ Use the Chorus to spread the sound to left and right.

⑨ For the Reverb, select a room-type effect, and set a short Time (if you wish to create more depth, a hall-type is also good.)

⑩ When playing this sound, connecting a Hold pedal will allow a more expressive electric piano performance.

[Sample settings]

| PATCH COMMON | | | | | | | | | | PATCH EFFECTS | | | | | | | | | |
|--------------|-------------|---------|------------------|-------------|----------------|------------|------|-------|------------|----------------------|---------|----------|---------|----------|---------------------|-------|--------|--|--|
| Patch Name | | | | | Patch Name | | | | | Group A sequence/SW | | | | | Group B Sequence/SW | | | | |
| - | | | | | E. Piano | | | | | PH → EN → OFF → OFF | | | | | CH → RV → OFF | | | | |
| Level | Bender | | Atouch bend sens | Solo | | Portamento | | | Distortion | | | | | Phaser | | | | | |
| | Down | Up | | SW | Legato | SW | Mode | Time | Type | Drive | Level | Manual | Rate | Depth | Reso | Mix | | | |
| 80 | 00 | 00 | 00 | off | off | | | | | | 560Hz | 1.0Hz | 53 | 38 | 80 | | | | |
| Key Range | | | | | | | | | | Spectrum | | | | | | | | | |
| Tone A | | Tone B | | Tone C | | Tone D | | Band1 | Band2 | Band3 | Band4 | Band5 | Band6 | Width | Enhancer | | | | |
| Low | High | Low | High | Low | High | Low | High | | | | | | | | Sens | Mix | | | |
| C-1 | G9 | C-1 | G9 | | | | | | | | | | | | 61 | 66 | | | |
| EQ | | | | | | | | | | Dry/Effect Balance B | | | | | Chorus | | | | |
| L-freq | L-gain | M-freq | Mid-Q | M-gain | H-freq | H-gain | | | | D: 44 | E: 56 | Rate | Depth | D-time | Feedback | Level | | | |
| 400Hz | 00dB | 2kHz | 0.5 | +03dB | 4kHz | 00dB | | | | | | 1.0Hz | 27 | 40ms | 00% | 55 | | | |
| MIDI Tx | | | | | | | | | | Delay | | | | | | | Reverb | | |
| Mode | Split Point | Channel | | Prog change | | Hold mode | | C-tap | C-level | L-tap | L-level | R-tap | R-level | Feedback | | | | | |
| | | Lower | Upper | Lower | Upper | | | ms | | ms | | ms | | % | | | | | |
| TONES | | | | | | | | | | Type | Pre dly | ER level | HF damp | Time | Level | | | | |
| Layer | A | B | C | D | ROOM2 | 00ms | 24 | 2kHz | 1.5s | 39 | | | | | | | | | |
| Active | ON | ON | OFF | OFF | TONES | | | | | | | A | B | C | D | | | | |
| Hold control | ON | ON | | | Filter mode | LPF | LPF | | | | | | | | | | | | |
| Velo curve | 02 | 04 | | | Cutoff freq | 57 | 45 | | | | | | | | | | | | |
| Rate | | | | | Resonance | 00 | 00 | | | | | | | | | | | | |
| Delay | | | | | ENV depth | +15 | +33 | | | | | | | | | | | | |
| Fade | | | | | Cutoff KF | 30 | 35 | | | | | | | | | | | | |
| Waveform | | | | | LFO select | ■ | ■ | | | | | | | | | | | | |
| Offset | | | | | LFO depth | 00 | 00 | | | | | | | | | | | | |
| Key trigger | | | | | Atouch sens | 00 | 00 | | | | | | | | | | | | |
| Rate | | | | | Velo sens | +40 | +40 | | | | | | | | | | | | |
| Delay | | | | | Time velo | 00 | +16 | | | | | | | | | | | | |
| Fade | | | | | Time KF | 00 | 00 | | | | | | | | | | | | |
| Waveform | | | | | Time 1 | 00 | 00 | | | | | | | | | | | | |
| Offset | | | | | Level 1 | 100 | 100 | | | | | | | | | | | | |
| Key trigger | | | | | Time 2 | 35 | 52 | | | | | | | | | | | | |
| Pitch coarse | 00 | 00 | | | Level 2 | 85 | 73 | | | | | | | | | | | | |
| Pitch fine | 00 | 00 | | | Time 3 | 72 | 74 | | | | | | | | | | | | |
| Pitch random | 00 | 00 | | | Sus level | 00 | 00 | | | | | | | | | | | | |
| Pitch KF | 100 | 100 | | | Time 4 | 47 | 47 | | | | | | | | | | | | |
| Atouch bend | OFF | OFF | | | Level 4 | 39 | 39 | | | | | | | | | | | | |
| Bender | OFF | OFF | | | Level | 89 | 100 | | | | | | | | | | | | |
| Waveform | 072 | 074 | | | Bias direction | UP | UP | | | | | | | | | | | | |
| Wave source | INT | INT | | | Bias point | C4 | C4 | | | | | | | | | | | | |
| Atouch sens | 00 | 00 | | | Bias level | 00 | 00 | | | | | | | | | | | | |
| LFO 1 depth | 00 | 00 | | | Atouch sens | 00 | 00 | | | | | | | | | | | | |
| LFO 2 depth | 00 | 00 | | | LFO select | ■ | ■ | | | | | | | | | | | | |
| Lever sens | 00 | 00 | | | LFO depth | 00 | 00 | | | | | | | | | | | | |
| Velo sens | 00 | 00 | | | Velo sens | +20 | +50 | | | | | | | | | | | | |
| Time velo | 00 | 00 | | | Time velo | 00 | +03 | | | | | | | | | | | | |
| Time KF | 00 | 00 | | | Time KF | 00 | +05 | | | | | | | | | | | | |
| Level 0 | 00 | 00 | | | Time 1 | 00 | 00 | | | | | | | | | | | | |
| Time 1 | 00 | 00 | | | Level 1 | 100 | 100 | | | | | | | | | | | | |
| Level 1 | 00 | 00 | | | Time 2 | 58 | 29 | | | | | | | | | | | | |
| Time 2 | 00 | 00 | | | Level 2 | 98 | 83 | | | | | | | | | | | | |
| Time 3 | 00 | 00 | | | Time 3 | 90 | 87 | | | | | | | | | | | | |
| Level 2 | 00 | 00 | | | Sus level | 00 | 00 | | | | | | | | | | | | |
| | | | | | Time 4 | 57 | 57 | | | | | | | | | | | | |

● Decay-type guitar

Here's how to create a decay-type guitar, such as acoustic guitar or clean-sounding electric guitar.

- ① Select a wave #058:Nylon Str.
- ② Create a decay-type TVF envelope, and set the ENV Depth to about +50.

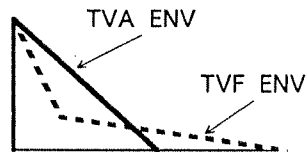

- ③ Set the TVF ENV Depth to about +50, and increase the Velocity Sensitivity of each envelope.
- ④ Make LFO1 settings, Atouch Mod settings, and Lever Sensitivity settings so that vibrato will be applied only when you apply aftertouch or move the modulation lever.
- ⑤ Use the EQ to slightly cut the mid range, and slightly boost the high range.
- ⑥ Connect the Delay after the Reverb.
- ⑦ Select a hall-type Reverb, and apply it fairly deeply.
- ⑧ Use the delay to lightly pan the original sound and reverb sound to left and right.
- ⑨ To simulate a 12-string guitar, use the Chorus, or copy a Tone to another Tone and detune the two.
- ⑩ When playing this sound, use velocity to create dynamics, and try to imitate the phrasing of a guitarist.

[Sample settings]

| PATCH COMMON | | | | | | | | | | PATCH EFFECTS | | | | | | | | | | | |
|----------------|-------------|---------|-------|-------------|------------|-----------|------|------------|------------|-----------------------|------------|---------|------------|---------------|---------------------|----------|-----|------|--|-------|--|
| Patch Name | | | | | Patch Name | | | | | Group A sequence/SW | | | | | Group B Sequence/SW | | | | | | |
| - | | | | | A. Guitar | | | | | OFF → OFF → OFF → OFF | | | | | RV → DL → OFF | | | | | | |
| Level | | Bender | | Atouch | | Solo | | Portamento | | Distortion | | | Phaser | | | | | | | | |
| 100 | 02 | 02 | 00 | OFF | OFF | OFF | OFF | OFF | OFF | Type | Drive | Level | Manual | Rate | Depth | Reso | Mix | | | | |
| Key Range | | | | | | | | | | Spectrum | | | | | | Enhancer | | | | | |
| Tone A | | Tone B | | Tone C | | Tone D | | Band1 | Band2 | Band3 | Band4 | Band5 | Band6 | Width | Sens | Mix | | | | | |
| Low | High | Low | High | Low | High | Low | High | | | | | | | | | | | | | | |
| C-1 | G9 | | | | | | | | | | | | | | | | | | | | |
| EQ | | | | | | | | | | Dry/Effect | | Chorus | | | | | | | | | |
| L-freq | L-gain | M-freq | Mid-Q | M-gain | H-freq | H-gain | | | | D: 44 | E: 56 | Rate | Depth | D-time | Feedback | Level | | | | | |
| 400Hz | 00dB | 1.6kHz | 1.0 | -03dB | 8kHz | +03dB | | | | | | Hz | | ms | % | | | | | | |
| MIDI Tx | | | | | | | | | | C-tap | | L-tap | | R-tap | | Delay | | | | | |
| Mode | Split Point | Channel | | Prog change | | Hold mode | | 220ms | C-level 47 | 150ms | L-level 34 | 180ms | R-level 43 | Feedback +38% | | | | | | | |
| TONES | | | | | | | | | | Type | | Pre dly | | ER level | | HF damp | | Time | | Level | |
| A | | B | | C | | D | | HALL3 | 00ms | 00 | 8kHz | 1.9s | 78 | | | | | | | | |
| Layer | | ON | | OFF | | OFF | | OFF | | OFF | | OFF | | OFF | | OFF | | | | | |
| Active | | ON | | OFF | | OFF | | OFF | | OFF | | OFF | | OFF | | OFF | | | | | |
| Hold control | | OFF | | | | | | | | | | | | | | | | | | | |
| Velo curve | | 04 | | | | | | | | | | | | | | | | | | | |
| Rate | | 78 | | | | | | | | | | | | | | | | | | | |
| Delay | | 00 | | | | | | | | | | | | | | | | | | | |
| Fade | | 00 | | | | | | | | | | | | | | | | | | | |
| Waveform | | TRI | | | | | | | | | | | | | | | | | | | |
| Offset | | 0 | | | | | | | | | | | | | | | | | | | |
| Key trigger | | ON | | | | | | | | | | | | | | | | | | | |
| Rate | | | | | | | | | | | | | | | | | | | | | |
| Delay | | | | | | | | | | | | | | | | | | | | | |
| Fade | | | | | | | | | | | | | | | | | | | | | |
| Waveform | | | | | | | | | | | | | | | | | | | | | |
| Offset | | | | | | | | | | | | | | | | | | | | | |
| Key trigger | | | | | | | | | | | | | | | | | | | | | |
| Pitch coarse | | 00 | | | | | | | | | | | | | | | | | | | |
| Pitch fine | | 00 | | | | | | | | | | | | | | | | | | | |
| Pitch randam | | 04 | | | | | | | | | | | | | | | | | | | |
| Pitch KF | | 100 | | | | | | | | | | | | | | | | | | | |
| Atouch bend | | OFF | | | | | | | | | | | | | | | | | | | |
| Bender | | ON | | | | | | | | | | | | | | | | | | | |
| Waveform | | 058 | | | | | | | | | | | | | | | | | | | |
| Wave source | | INT | | | | | | | | | | | | | | | | | | | |
| Atouch sens | | 17 | | | | | | | | | | | | | | | | | | | |
| LFO 1 depth | | 00 | | | | | | | | | | | | | | | | | | | |
| LFO 2 depth | | 00 | | | | | | | | | | | | | | | | | | | |
| Velo sens | | 33 | | | | | | | | | | | | | | | | | | | |
| Velo sens | | 00 | | | | | | | | | | | | | | | | | | | |
| Time velo | | 00 | | | | | | | | | | | | | | | | | | | |
| Time KF | | 00 | | | | | | | | | | | | | | | | | | | |
| Level 0 | | 00 | | | | | | | | | | | | | | | | | | | |
| Time 1 | | 00 | | | | | | | | | | | | | | | | | | | |
| Level 1 | | 00 | | | | | | | | | | | | | | | | | | | |
| Time 2 | | 00 | | | | | | | | | | | | | | | | | | | |
| Time 3 | | 00 | | | | | | | | | | | | | | | | | | | |
| Level 2 | | 00 | | | | | | | | | | | | | | | | | | | |
| Level 3 | | 00 | | | | | | | | | | | | | | | | | | | |
| Level 4 | | 00 | | | | | | | | | | | | | | | | | | | |
| Level 1 | | 100 | | | | | | | | | | | | | | | | | | | |
| Bias direction | | UP | | | | | | | | | | | | | | | | | | | |
| Bias point | | C4 | | | | | | | | | | | | | | | | | | | |
| Bias level | | 00 | | | | | | | | | | | | | | | | | | | |
| Atouch sens | | 00 | | | | | | | | | | | | | | | | | | | |
| LFO select | | 1 | | | | | | | | | | | | | | | | | | | |
| LFO depth | | 00 | | | | | | | | | | | | | | | | | | | |
| Velo sens | | +37 | | | | | | | | | | | | | | | | | | | |
| Time velo | | +25 | | | | | | | | | | | | | | | | | | | |
| Time KF | | +03 | | | | | | | | | | | | | | | | | | | |
| Time 1 | | 00 | | | | | | | | | | | | | | | | | | | |
| Level 1 | | 100 | | | | | | | | | | | | | | | | | | | |
| Time 2 | | 77 | | | | | | | | | | | | | | | | | | | |
| Level 2 | | 00 | | | | | | | | | | | | | | | | | | | |
| Time 3 | | 73 | | | | | | | | | | | | | | | | | | | |
| Sus level | | 00 | | | | | | | | | | | | | | | | | | | |
| Time 4 | | 50 | | | | | | | | | | | | | | | | | | | |

● Distortion guitar

Here's how to create a sustain-type guitar sound such as a distorted guitar.

- ① Make a "square" TVA envelope.

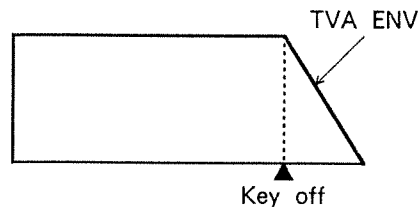

- ② Connect effects in the order of Distortion/Enhancer/Chorus/Reverb.
- ③ For the Distortion, set Drive to a high value, and use Level to adjust the overall volume.
- ④ Use the Enhancer to add brilliance to the sound.
- ⑤ For the Chorus, increase the Feedback for a flanger-like effect.
- ⑥ Set the Reverb to produce a lot of reflections.
- ⑦ Select #074 as the wave. Other waves containing many partials such as #014, #040, or #061 are also effective.
- ⑧ Use the filter in LPF mode, and set a low cutoff frequency.
- ⑨ With Bender Range settings such as D:12/U:7, you can use the bender to simulate the vibrato arm of a guitar. Set aftertouch to lower the pitch over a range of three semitone steps.
- ⑩ When playing chords, octaves and fifths are effective. If this results in excessive distortion, modify the Distortion Type or Drive settings, or try changing the Wave or Cutoff Frequency.
- ⑪ When playing single notes, it is effective to apply Solo/Portamento.

[Sample settings]

| PATCH COMMON | | | | | | | | | | PATCH EFFECTS | | | | | | | | | |
|--------------|--------------|---------|-----------|-------------|-------------|------------|------|-------------|-------------|---------------------|-----------|---------|----------|---------|------------------|-----|--|--|--|
| Patch Name | | | | | Patch Name | | | | | Group A sequence/SW | | | | | Group B Sequence | | | | |
| - | | | | | Dist Guitar | | | | | DS → EN → OFF → OFF | | | | | CH → RV → OFF | | | | |
| Bender | | Atouch | | Solo | | Portamento | | Distortion | | | | | Phaser | | | | | | |
| Level | Down | Up | bend sens | SW | Legato | SW | Mode | Time | Type | Drive | Level | Manual | Rate | Depth | Reso | Mix | | | |
| 100 | 12 | 07 | -02 | OFF | OFF | OFF | | | MELLOW DIST | 100 | 34 | Hz | Hz | | | | | | |
| Key Range | | | | | | | | | | Spectrum | | | | | Enhancer | | | | |
| Tone A | | Tone B | | Tone C | | Tone D | | Band1 | Band2 | Band3 | Band4 | Band5 | Band6 | Width | Sens | Mix | | | |
| Low | High | Low | High | Low | High | Low | High | | | | | | | | 71 | 47 | | | |
| C-1 | | G9 | | | | | | Dry/Effect | | | | | Chorus | | | | | | |
| | | | | | | | | Balance B | | Rate | Depth | D-time | Feedback | Level | | | | | |
| | | | | | | | | D: 47 E: 53 | | 0.6Hz | 10 | 9.5ms | +74% | 100 | | | | | |
| EQ | | | | | | | | | | Delay | | | | | | | | | |
| L-freq | L-gain | M-freq | Mid-Q | M-gain | H-freq | H-gain | | | C-tap | C-level | L-tap | L-level | R-tap | R-level | Feedback | | | | |
| Hz | dB | Hz | | dB | Hz | dB | | | ms | | ms | | ms | | % | | | | |
| MIDI Tx | | | | | | | | | | Reverb | | | | | | | | | |
| Mode | Split Point | Channel | | Prog change | | Hold mode | | Type | Pre dly | ER level | HF damp | Time | Level | | | | | | |
| | | Lower | Upper | Lower | Upper | | | HALL1 | 00ms | 85 | BYPASS | 1.0s | 35 | | | | | | |
| TONES | | | | | | | | | | TONES | | | | | | | | | |
| | | A | | B | | C | | D | | A | | B | | C | | D | | | |
| Layer | | ON | | OFF | | OFF | | OFF | | Filter mode | | LPF | | | | | | | |
| Active | | ON | | OFF | | OFF | | OFF | | Cutoff freq | | 100 | | | | | | | |
| COM | Hold control | ON | | | | | | | | TVF | Resonance | 00 | | | | | | | |
| | Velo curve | 03 | | | | | | | | | ENV depth | 00 | | | | | | | |
| LFO 1 | Rate | | | | | | | | | Cutoff KF | 100 | | | | | | | | |
| | Delay | | | | | | | | | LFO select | █ | | | | | | | | |
| | Fade | | | | | | | | | LFO depth | 00 | | | | | | | | |
| | Waveform | | | | | | | | | Atouch sens | 00 | | | | | | | | |
| | Offset | | | | | | | | | Velo sens | | | | | | | | | |
| LFO 2 | Key trigger | | | | | | | | | Time velo | | | | | | | | | |
| | Rate | | | | | | | | | Time KF | | | | | | | | | |
| | Delay | | | | | | | | | Time 1 | | | | | | | | | |
| | Fade | | | | | | | | | Level 1 | | | | | | | | | |
| | Waveform | | | | | | | | | Time 2 | | | | | | | | | |
| VG | Offset | | | | | | | | | Level 2 | | | | | | | | | |
| | Key trigger | | | | | | | | | Time 3 | | | | | | | | | |
| | Pitch coarse | -12 | | | | | | | | Sus level | | | | | | | | | |
| | Pitch fine | 00 | | | | | | | | Time 4 | | | | | | | | | |
| | Pitch randam | 00 | | | | | | | | Level 4 | | | | | | | | | |
| | Pitch KF | 100 | | | | | | | | Level | 100 | | | | | | | | |
| | Atouch bends | ON | | | | | | | | Bias direction | UP | | | | | | | | |
| | Bender | ON | | | | | | | | Bias point | C4 | | | | | | | | |
| | Waveform | 074 | | | | | | | | Bias level | 00 | | | | | | | | |
| | Wave source | INT | | | | | | | | Atouch sens | 00 | | | | | | | | |
| PITCH ENV | Atouch sens | 00 | | | | | | | | LFO select | █ | | | | | | | | |
| | LFO 1 depth | 00 | | | | | | | | LFO depth | 00 | | | | | | | | |
| | LFO 2 depth | 00 | | | | | | | | Velo sens | +50 | | | | | | | | |
| | Lever sens | 00 | | | | | | | | Time velo | 00 | | | | | | | | |
| | Velo sens | 00 | | | | | | | | Time KF | 00 | | | | | | | | |
| | Time velo | 00 | | | | | | | | Time 1 | 00 | | | | | | | | |
| | Time KF | 00 | | | | | | | | Level 1 | 100 | | | | | | | | |
| | Time 0 | 00 | | | | | | | | Time 2 | 00 | | | | | | | | |
| | Time 1 | 00 | | | | | | | | Level 2 | 100 | | | | | | | | |
| | Time 1 | 00 | | | | | | | | Time 3 | 00 | | | | | | | | |
| TVA | Time 2 | 00 | | | | | | | | Sus level | 100 | | | | | | | | |
| | Time 3 | 00 | | | | | | | | Time 4 | 14 | | | | | | | | |
| | Time 4 | 00 | | | | | | | | | | | | | | | | | |
| | Level 0 | 00 | | | | | | | | | | | | | | | | | |
| | Level 1 | 00 | | | | | | | | | | | | | | | | | |

Initialize setting

«Note»

Parameter values of a patch contained in a card that has been initialized (☞ P. IV – 2) will be displayed as follows:

These values are suitable for creating sound from scratch. You can begin to create many original sounds based on these settings. You can also create sounds to match the internal patches by adjusting the value of each parameter to match those of the internal patches or by copying a patch from an initialized card (☞ P. I – 86) to the internal memory.

[Sample settings]

| PATCH COMMON | | | | | | | | | | PATCH EFFECTS | | | | | | | | | | | | | | | | | | | | | | | | | | | | | | | | | | |
|--------------|----------------|--------------|-----------|--------|---------------|-------------|------------|-------|-------|-----------------------|--------|-------|---------|----------|---------------------|------|-------|----|--|-------|-----|----|--|--|---------|-----|------|--|--|----------|--|------|--|--|---------|--|----|--|--|----------|--|--|--|--|
| Patch Name | | | | | Patch Name | | | | | Group A sequence/SW | | | | | Group B Sequence/SW | | | | | | | | | | | | | | | | | | | | | | | | | | | | | |
| - | | | | | Initial Patch | | | | | OFF → OFF → OFF → OFF | | | | | OFF → OFF → OFF | | | | | | | | | | | | | | | | | | | | | | | | | | | | | |
| Level | Bender | | Atouch | | Solo | | Portamento | | | Distortion | | | | | Phaser | | | | | | | | | | | | | | | | | | | | | | | | | | | | | |
| | Down | Up | bend sens | | SW | Legato | SW | Mode | Time | Type | Drive | Level | Manual | Rate | Depth | Reso | Mix | | | | | | | | | | | | | | | | | | | | | | | | | | | |
| 100 | 02 | 02 | + 12 | | OFF | OFF | OFF | NRM | 50 | M-DIST | 50 | 70 | 380Hz | 2.0Hz | 30 | 50 | 100 | | | | | | | | | | | | | | | | | | | | | | | | | | | |
| Key Range | | | | | | | | | | Spectrum | | | | | Enhancer | | | | | | | | | | | | | | | | | | | | | | | | | | | | | |
| Tone A | | Tone B | | Tone C | | Tone D | | | Band1 | Band2 | Band3 | Band4 | Band5 | Band6 | Width | Sens | Mix | | | | | | | | | | | | | | | | | | | | | | | | | | | |
| Low | High | Low | High | Low | High | Low | High | Low | High | + 10 | + 10 | + 10 | + 10 | + 10 | + 10 | 03 | 50 | 50 | | | | | | | | | | | | | | | | | | | | | | | | | | |
| C-1 | G9 | C-1 | G9 | C-1 | G9 | C-1 | G9 | C-1 | G9 | Dry/Effect | | | | | Chorus | | | | | | | | | | | | | | | | | | | | | | | | | | | | | |
| EQ | | | | | | | | | | Balance B | | | | | Rate | | | | | Depth | | | | | D-time | | | | | Feedback | | | | | Level | | | | | | | | | |
| L-freq | L-gain | M-freq | Mid-Q | M-gain | H-freq | H-gain | | | | D: 50 | E: 50 | 0.3Hz | 60 | 30ms | + 50% | 100 | Delay | | | | | | | | | | | | | | | | | | | | | | | | | | | |
| 400Hz | 00dB | 1kHz | 0.5 | 00dB | 4kHz | 00dB | | | | C-tap | | | | | C-level | | | | | L-tap | | | | | L-level | | | | | R-tap | | | | | R-level | | | | | Feedback | | | | |
| MIDI Tx | | | | | | | | | | 300ms | | | | | 50 | | | | | 100ms | | | | | 50 | | | | | 200ms | | | | | 50 | | | | | + 50% | | | | |
| Mode | Split Point | Channel | | | | Prog change | | | | Hold mode | Reverb | | | | | | | | | | | | | | | | | | | | | | | | | | | | | | | | | |
| | | Lower | Upper | Lower | Upper | Lower | Upper | Lower | Upper | | Both | Type | Pre dly | ER level | HF damp | Time | Level | | | | | | | | | | | | | | | | | | | | | | | | | | | |
| SPLIT | C4 | 02 | 01 | 002 | 001 | BOTH | HALL 1 | | | | | | | | | | 30ms | | | | | 50 | | | | | 8kHz | | | | | 2.5s | | | | | 70 | | | | | | | |
| TONES | | | | | | | | | | A | | | | | B | | | | | C | | | | | D | | | | | | | | | | | | | | | | | | | |
| Layer | | | | | | | | | | ON | | | | | OFF | | | | | OFF | | | | | OFF | | | | | | | | | | | | | | | | | | | |
| Active | | | | | | | | | | ON | | | | | OFF | | | | | OFF | | | | | OFF | | | | | | | | | | | | | | | | | | | |
| COM | Hold control | | | | | | | | | | ON | | | | | ON | | | | | ON | | | | | ON | | | | | | | | | | | | | | | | | | |
| | Velo curve | | | | | | | | | | 03 | | | | | 03 | | | | | 03 | | | | | 03 | | | | | | | | | | | | | | | | | | |
| LFO 1 | Rate | | | | | | | | | | 75 | | | | | 75 | | | | | 75 | | | | | 75 | | | | | | | | | | | | | | | | | | |
| | Delay | | | | | | | | | | 00 | | | | | 00 | | | | | 00 | | | | | 00 | | | | | | | | | | | | | | | | | | |
| | Fade | | | | | | | | | | 00 | | | | | 00 | | | | | 00 | | | | | 00 | | | | | | | | | | | | | | | | | | |
| | Waveform | | | | | | | | | | TRI | | | | | TRI | | | | | TRI | | | | | TRI | | | | | | | | | | | | | | | | | | |
| | Offset | | | | | | | | | | 0 | | | | | 0 | | | | | 0 | | | | | 0 | | | | | | | | | | | | | | | | | | |
| | Key trigger | | | | | | | | | | ON | | | | | ON | | | | | ON | | | | | ON | | | | | | | | | | | | | | | | | | |
| | LFO 2 | Rate | | | | | | | | | | 50 | | | | | 50 | | | | | 50 | | | | | 50 | | | | | | | | | | | | | | | | | |
| | | Delay | | | | | | | | | | 00 | | | | | 00 | | | | | 00 | | | | | 00 | | | | | | | | | | | | | | | | | |
| Fade | | | | | | | | | | 00 | | | | | 00 | | | | | 00 | | | | | 00 | | | | | | | | | | | | | | | | | | | |
| Waveform | | | | | | | | | | TRI | | | | | TRI | | | | | TRI | | | | | TRI | | | | | | | | | | | | | | | | | | | |
| Offset | | | | | | | | | | 0 | | | | | 0 | | | | | 0 | | | | | 0 | | | | | | | | | | | | | | | | | | | |
| Key trigger | | | | | | | | | | ON | | | | | ON | | | | | ON | | | | | ON | | | | | | | | | | | | | | | | | | | |
| WG | | Pitch coarse | | | | | | | | | | 00 | | | | | 00 | | | | | 00 | | | | | 00 | | | | | | | | | | | | | | | | | |
| | | Pitch fine | | | | | | | | | | 00 | | | | | 00 | | | | | 00 | | | | | 00 | | | | | | | | | | | | | | | | | |
| | Pitch randam | | | | | | | | | | 00 | | | | | 00 | | | | | 00 | | | | | 00 | | | | | | | | | | | | | | | | | | |
| | Pitch KF | | | | | | | | | | 100 | | | | | 100 | | | | | 100 | | | | | 100 | | | | | | | | | | | | | | | | | | |
| | Atouch bend | | | | | | | | | | OFF | | | | | OFF | | | | | OFF | | | | | OFF | | | | | | | | | | | | | | | | | | |
| | Bender | | | | | | | | | | ON | | | | | ON | | | | | ON | | | | | ON | | | | | | | | | | | | | | | | | | |
| | Waveform | | | | | | | | | | 001 | | | | | 001 | | | | | 001 | | | | | 001 | | | | | | | | | | | | | | | | | | |
| | Wave source | | | | | | | | | | INT | | | | | INT | | | | | INT | | | | | INT | | | | | | | | | | | | | | | | | | |
| | Atouch sens | | | | | | | | | | 00 | | | | | 00 | | | | | 00 | | | | | 00 | | | | | | | | | | | | | | | | | | |
| | LFO 1 depth | | | | | | | | | | 00 | | | | | 00 | | | | | 00 | | | | | 00 | | | | | | | | | | | | | | | | | | |
| LFO 2 depth | | | | | | | | | | 00 | | | | | 00 | | | | | 00 | | | | | 00 | | | | | | | | | | | | | | | | | | | |
| Lever sens | | | | | | | | | | 130 | | | | | 130 | | | | | 130 | | | | | 130 | | | | | | | | | | | | | | | | | | | |
| PITCH ENV | Velo sens | | | | | | | | | | 00 | | | | | 00 | | | | | 00 | | | | | 00 | | | | | | | | | | | | | | | | | | |
| | Time velo | | | | | | | | | | 00 | | | | | 00 | | | | | 00 | | | | | 00 | | | | | | | | | | | | | | | | | | |
| | Time KF | | | | | | | | | | 00 | | | | | 00 | | | | | 00 | | | | | 00 | | | | | | | | | | | | | | | | | | |
| | Level 0 | | | | | | | | | | 00 | | | | | 00 | | | | | 00 | | | | | 00 | | | | | | | | | | | | | | | | | | |
| | Time 1 | | | | | | | | | | 50 | | | | | 50 | | | | | 50 | | | | | 50 | | | | | | | | | | | | | | | | | | |
| | Level 1 | | | | | | | | | | 00 | | | | | 00 | | | | | 00 | | | | | 00 | | | | | | | | | | | | | | | | | | |
| | Time 2 | | | | | | | | | | 50 | | | | | 50 | | | | | 50 | | | | | 50 | | | | | | | | | | | | | | | | | | |
| | Time 3 | | | | | | | | | | 50 | | | | | 50 | | | | | 50 | | | | | 50 | | | | | | | | | | | | | | | | | | |
| | Level 2 | | | | | | | | | | 00 | | | | | 00 | | | | | 00 | | | | | 00 | | | | | | | | | | | | | | | | | | |
| | Time 4 | | | | | | | | | | 50 | | | | | 50 | | | | | 50 | | | | | 50 | | | | | | | | | | | | | | | | | | |
| TVA | Filter mode | | | | | | | | | | LPF | | | | | LPF | | | | | LPF | | | | | LPF | | | | | | | | | | | | | | | | | | |
| | Cutoff freq | | | | | | | | | | 100 | | | | | 100 | | | | | 100 | | | | | 100 | | | | | | | | | | | | | | | | | | |
| | Resonance | | | | | | | | | | 00 | | | | | 00 | | | | | 00 | | | | | 00 | | | | | | | | | | | | | | | | | | |
| | ENV depth | | | | | | | | | | 00 | | | | | 00 | | | | | 00 | | | | | 00 | | | | | | | | | | | | | | | | | | |
| | Cutoff KF | | | | | | | | | | 100 | | | | | 100 | | | | | 100 | | | | | 100 | | | | | | | | | | | | | | | | | | |
| | LFO select | | | | | | | | | | 1 | | | | | 1 | | | | | 1 | | | | | 1 | | | | | | | | | | | | | | | | | | |
| | LFO depth | | | | | | | | | | 00 | | | | | 00 | | | | | 00 | | | | | 00 | | | | | | | | | | | | | | | | | | |
| | Atouch sens | | | | | | | | | | 00 | | | | | 00 | | | | | 00 | | | | | 00 | | | | | | | | | | | | | | | | | | |
| | TVF ENV | Velo sens | | | | | | | | | | 00 | | | | | 00 | | | | | 00 | | | | | 00 | | | | | | | | | | | | | | | | | |
| | | Time velo | | | | | | | | | | 00 | | | | | 00 | | | | | 00 | | | | | 00 | | | | | | | | | | | | | | | | | |
| Time KF | | | | | | | | | | 00 | | | | | 00 | | | | | 00 | | | | | 00 | | | | | | | | | | | | | | | | | | | |
| Time 1 | | | | | | | | | | 00 | | | | | 00 | | | | | 00 | | | | | 00 | | | | | | | | | | | | | | | | | | | |
| Level 1 | | | | | | | | | | 100 | | | | | 100 | | | | | 100 | | | | | 100 | | | | | | | | | | | | | | | | | | | |
| Time 2 | | | | | | | | | | 50 | | | | | 50 | | | | | 50 | | | | | 50 | | | | | | | | | | | | | | | | | | | |
| Level 2 | | | | | | | | | | 100 | | | | | 100 | | | | | 100 | | | | | 100 | | | | | | | | | | | | | | | | | | | |
| Time 3 | | | | | | | | | | 50 | | | | | 50 | | | | | 50 | | | | | 50 | | | | | | | | | | | | | | | | | | | |
| Level 3 | | | | | | | | | | 100 | | | | | 100 | | | | | 100 | | | | | 100 | | | | | | | | | | | | | | | | | | | |
| Time 4 | | | | | | | | | | 50 | | | | | 50 | | | | | 50 | | | | | 50 | | | | | | | | | | | | | | | | | | | |
| TVF ENV | Level | | | | | | | | | | 80 | | | | | 80 | | | | | 80 | | | | | 80 | | | | | | | | | | | | | | | | | | |
| | Bias direction | | | | | | | | | | UP | | | | | UP | | | | | UP | | | | | UP | | | | | | | | | | | | | | | | | | |
| | Bias point | | | | | | | | | | C4 | | | | | C4 | | | | | C4 | | | | | C4 | | | | | | | | | | | | | | | | | | |
| | Bias level | | | | | | | | | | 00 | | | | | 00 | | | | | 00 | | | | | 00 | | | | | | | | | | | | | | | | | | |
| | Atouch sens | | | | | | | | | | 00 | | | | | 00 | | | | | 00 | | | | | 00 | | | | | | | | | | | | | | | | | | |
| | LFO select | | | | | | | | | | 1 | | | | | 1 | | | | | 1 | | | | | 1 | | | | | | | | | | | | | | | | | | |
| | LFO depth | | | | | | | | | | 00 | | | | | 00 | | | | | 00 | | | | | 00 | | | | | | | | | | | | | | | | | | |
| | TVA ENV | Velo sens | | | | | | | | | | 00 | | | | | 00 | | | | | 00 | | | | | 00 | | | | | | | | | | | | | | | | | |
| | | Time velo | | | | | | | | | | 00 | | | | | 00 | | | | | 00 | | | | | 00 | | | | | | | | | | | | | | | | | |
| | | Time KF | | | | | | | | | | 00 | | | | | 00 | | | | | 00 | | | | | 00 | | | | | | | | | | | | | | | | | |
| Time 1 | | | | | | | | | | 00 | | | | | 00 | | | | | 00 | | | | | 00 | | | | | | | | | | | | | | | | | | | |
| Level 1 | | | | | | | | | | 100 | | | | | 100 | | | | | 100 | | | | | 100 | | | | | | | | | | | | | | | | | | | |
| Time 2 | | | | | | | | | | 50 | | | | | 50 | | | | | 50 | | | | | 50 | | | | | | | | | | | | | | | | | | | |
| Level 2 | | | | | | | | | | 100 | | | | | 100 | | | | | 100 | | | | | 100 | | | | | | | | | | | | | | | | | | | |
| Time 3 | | | | | | | | | | 50 | | | | | 50 | | | | | 50 | | | | | 50 | | | | | | | | | | | | | | | | | | | |
| Level 3 | | | | | | | | | | 100 | | | | | 100 | | | | | 100 | | | | | 100 | | | | | | | | | | | | | | | | | | | |
| Time 4 | | | | | | | | | | 50 | | | | | 50 | | | | | 50 | | | | | 50 | | | | | | | | | | | | | | | | | | | |

ROM PLAY

This mode allows you to hear the built-in demo songs. Single mode and Multi mode have one song respectively.

*** This function is available only in play mode (or while you are moving the front panel sliders). It is not available during editing or writing operations.**

- ① While holding **EXIT**, press **INC/YES**.

```

===== ROM PLAY =====
          Introduction
    
```

- ② Press **INC/YES** to begin playback.

```

===== PLAYING =====
          **** JD-800 ****
    
```

- ③ Press **DEC/NO** to stop playback.

- ④ Press **EXIT** to return to the previous display.

*** During ROM Play, messages are not received from MIDI IN.**

*** The musical data of the song is not transmitted from MIDI OUT.**

*** In order for you to create songs like the ROM Play song, you will need a sequencer or other external device.**

| Single mode | Multi mode |
|--|---|
| <p>“Introduction” Music by Adrian Scott & Tatsuya Nishiwaki Copyright © 1991, Adrian Scott</p> | <p>“Eau De Vie” Music by Adrian Scott Copyright © 1991, Adrian Scott</p> |
| <p>Biography of Composer</p> | |
| <p>Adrian Scott Adrian Scott formerly handled the vocals and keyboards for the popular group from Australia, “Air Supply”. Since following the solo path, he in 1984 won the Silver Prize at the “World Song Festival Tokyo '84”. Currently, he is involved as a producer of commercial music and music for films. In addition, as a session player, he has performed along with a number of Australia’s top musicians, including John Farnham and Kylie Minogue. He lives in Melbourne, Australia.</p> | |
| <p>Tatsuya Nishiwaki Debuted in 1987 as a member of “PAZZ” for CBS/Sony records. After the group’s dissolution in '88, he was involved in the production of numerous albums (composing, arranging and playing keyboards). His work, and his individualistic style of playing, have won him wide acclaim. His particular musical sensibility results in emotional, exciting keyboard playing, combined with arrangements which deftly support his style. “Introduction” offers a good measure of wild playing combined with distorted sounds (Plus Distortion!).</p> | |
| <p>Warning : All rights reserved. Unauthorized use of this material is a violation of applicable laws.</p> | |

SUPPLEMENTARY MATERIAL

● Error messages

If you operate the JD-800 incorrectly or if an operation could not be executed properly, an error message will appear in the display. Refer to this section and take the appropriate action.

○ Messages when you turn the power on

Internal battery low

Reason : The internal backup battery is low.

Action : This display will disappear in a short time. Contact the nearest Roland service station. (⇐ back cover)

○ Messages when you select a Patch

DATA card is not ready

Reason : A DATA card is not inserted into the DATA card slot, or is incorrectly inserted.

Action : This display will disappear in a short time. Make sure that the DATA card is inserted correctly.

DATA card battery low

Reason : The backup battery of the DATA card is low.

Action : This display will disappear in a short time. Refer to the instructions included with the DATA card and replace the battery (CR2016).

Wrong DATA card

Reason : An uninitialized DATA card (or a DATA card for another device) has been inserted into the DATA card slot.

Action : This display will disappear in a short time. If you wish to initialize the card, refer to P. IV – 2.

○ Messages when you select a WAVEFORM card

| | |
|---|-------------------------------|
| SINGLE 001 CH:01 I-11:Digital Synth 1 | WAVEFORM card is not ready |
|---|-------------------------------|

Reason : A WAVEFORM card is not inserted into the WAVEFORM slot, or is incorrectly inserted.

Action : This display will disappear in a short time. Make sure that the WAVEFORM card is correctly inserted.

○ Messages during Write or Data Transfer operations

| |
|------------------------|
| DATA card is not ready |
|------------------------|

Reason : A DATA card is not inserted into the DATA slot, or is incorrectly inserted.

Action : This display will disappear in a short time. Make sure that the DATA card is inserted correctly.

| |
|------------------------|
| DATA card is protected |
|------------------------|

Reason : The protect switch of the DATA card is ON.

Action : This display will disappear in a short time. Turn the protect switch of the DATA card to OFF, and try the operation again.

| |
|-----------------|
| DATA card error |
|-----------------|

Reason : It is possible that the Data Card has come out the slot during data transmission.

Action : Make sure that the Data Card is properly inserted and then try the operation again.

○ Messages while receiving MIDI data

| |
|------------|
| MIDI error |
|------------|

Reason : More MIDI data was received in a short time than the JD-800 was able to handle.

Action : Reduce the amount of MIDI data being transmitted by the external device.

□ Troubleshooting

If problems occur while you are playing or operating the JD-800, refer to this section. If you are not able to determine the cause, or if the problem is not solved, contact your dealer or the nearest Roland service station.

○ No sound

● Is the VOLUME lowered?

Check the VOLUME slider of the JD-800, and the volume of your mixer/amp system.

● Can you hear sound through the headphones?

If you do, it is possible that the connecting cables are broken, or the amp or mixer is faulty. Check the connecting cables and equipment once again.

● Is the MIDI parameter Local Control set to “off”?

Set this to Local On (☞ P. III – 11).

● Are the levels of the Tone/Part/Patch set too low?

Check the Tone TVA level (☞ P. I – 67), Part level (☞ P. II – 9), and Patch level (☞ P. I – 119).

● Are the Tones muted?

Check the Layer settings (☞ P. I – 5).

● Are the Key Range settings of the Tone correct?

Check the Key Range settings (☞ P. I – 120).

● Has a MIDI volume message been received from an external device to lower the level of the Part?

Select another Patch, or select Single/Multi mode.

● If a pedal is connected to the EXT CONT jack, has it been set to “VOL”?

Press the volume pedal.

● Is the JD-800 in ROM Play mode or Data Transfer mode?

Press **EXIT** to return to play mode.

● In single mode, are the effect settings correct?

Check the effect's on/off status (☞ P. I – 91) and DRY/EFFECT balance B (☞ P. I – 94).

● In single mode, is the level setting of each effect correct?

Check the settings of the distortion level (☞ P. I – 96) and spectrum (☞ P. I – 100).

● Are the patch equalizer settings correct?

It is possible for a sound to become weaker as a band's gain is lowered. Please check the equalizer settings (☞ P. I – 138).

○ Pitch is incorrect

● **Is the Master Tune value correct?**

Set the correct value (☞ P. III – 4).

● **Is Transpose turned on?**

Press **TRANSPOSE** to turn it off (☞ P. III – 5).

● **Are the pitch settings of the Tone correct?**

Check the values of Pitch Coarse (☞ P. I – 28), Pitch Fine (☞ P. I – 29), Pitch Random (☞ P. I – 30), and Pitch Key Follow (☞ P. I – 31).

● **Has a Pitch Bend message been received from an external device?**

Move the bender lever.

○ Cannot select Patches

● **Is the MIDI parameter Local Control turned off?**

Turn Local Control on (☞ P. III – 11).

● **Is the MIDI parameter Program Change Reception turned off?**

If you wish to select Patches from an external device, turn Program Change Reception (☞ P. II – 18) on.

● **Is the JD-800 in ROM Play mode or Data Transfer mode?**

Press **EXIT** to return to play mode.

● **Are you editing a Patch or Special Setup?**

Press **EXIT** to return to play mode.

○ Cannot hear the Effects

● **In Single mode, are the Patch Effect settings correct?**

Check the Effect Sequence settings (☞ P. I – 90), and the levels of each effect.

● **In Multi mode, are the Part Output Assign settings correct?**

Check the Output Assign settings (☞ P. II – 11).

● **In Multi mode, are the Part Effect Level settings correct?**

Check the Effect Level settings (☞ P. II – 13).

● **In Multi mode, are the Effects settings correct?**

Check the level of each effect (☞ P. II – 32, II – 33, II – 34).

● **Is the Effect Master Switches turned off?**

Turn the Effect Master Switches on (☞ P. III – 9).

○ Cannot set Pan

● Are you in Single mode?

Pan cannot be set in Single mode.

● In Multi mode, is EXT CONT set to "PAN"?

Press the pedal to check.

○ Cannot apply Portamento

● Is Solo turned off?

Press both **SOLO** and **PORTAMENTO**.

● Is the Portamento Time value correct?

Set Portamento Time (☞ P. I – 128) to a value other than 0.

● Has a MIDI Portamento Switch messages been received to turn portamento off?

Try turning on both **SOLO** and **PORTAMENTO** once again.

○ Cannot use a card

● Are you using a DATA card that has not been initialized?

Please initialize the card before using (☞ P. IV – 2).

● Are you using a PCM card from another device?

The JD-800 is able to use only SO-JD80 series WAVEFORM cards. PCM cards from another series cannot be used.

○ MIDI messages are not received correctly

● Are the receive channel settings correct?

Check the MIDI receive channel settings (☞ P. III – 15, II – 8).

● Are the Exclusive Reception settings correct?

Check the settings for Exclusive Reception (☞ P. III – 23), and Unit Number (☞ P. III – 12).

WAVEFORM LIST

*The Type is indicated as follows: S-loop: short loop waveforms, L-loop: long loop waveforms, O-shot: one shot waveforms.

| No. | Wave name | Remarks | Type |
|-----|------------|---|----------|
| 001 | Syn Saw 1 | Analog synth sharp sawtooth wave | S – loop |
| 002 | Syn Saw 2 | Analog synth thin sawtooth wave | S – loop |
| 003 | FAT Saw | Analog synth thick sawtooth wave | S – loop |
| 004 | FAT Square | Analog synth square wave | S – loop |
| 005 | Syn Pulse1 | Analog synth pulse wave (duty cycle 50%) | S – loop |
| 006 | Syn Pulse2 | Analog synth pulse wave (duty cycle 30%) | S – loop |
| 007 | Syn Pulse3 | Analog synth pulse wave (duty cycle 20%) | S – loop |
| 008 | Syn Pulse4 | Analog synth pulse wave (duty cycle 14%) | S – loop |
| 009 | Syn Pulse5 | Analog synth pulse wave (duty cycle 7%) | S – loop |
| 010 | Pulse Mod | Pulse width modulation wave | L – loop |
| 011 | Triangle | Analog synth triangle wave | S – loop |
| 012 | Syn Sine | Analog synth sine wave | S – loop |
| 013 | Soft Pad | Soft analog synth wave | L – loop |
| 014 | Wire Str | Metalic string sound | S – loop |
| 015 | MIDI Clav | Clav sound with sharp attack | L – loop |
| 016 | Spark Vox1 | Processed human voice 1 | S – loop |
| 017 | Spark Vox2 | Processed human voice 2 | S – loop |
| 018 | Syn Sax | Synth sax | S – loop |
| 019 | Clav Wave | Processed clav-type wave | S – loop |
| 020 | Cello Wave | Processed cello wave | S – loop |
| 021 | BrightDigi | Bright harpsichord-like sound | S – loop |
| 022 | Cutters | Sharp and distorted sound | S – loop |
| 023 | Syn Bass | Thick synth bass | S – loop |
| 024 | Rad Hose | Soft woodwind with a unique attack | S – loop |
| 025 | Vocal Wave | Breathy sound extracted from human voice | S – loop |
| 026 | Wally Wave | Rough digital synth sound | S – loop |
| 027 | Brusky Ip | Thick digital synth sound | S – loop |
| 028 | Digiwave | Unique sound with many high partials | S – loop |
| 029 | Can Wave 1 | Sound with the attack of a struck can | S – loop |
| 030 | Can Wave 2 | Sound with the attack of a blown woodwind | S – loop |
| 031 | EML 5th | Perfect 5th chord created on a synth | S – loop |
| 032 | Wave Scan | Clav-type digital synth sound | S – loop |
| 033 | Nasty | Sound with a very rough low frequency range | S – loop |
| 034 | Wave Table | Slightly dark digital synth sound | S – loop |
| 035 | Fine Wine | Finger rubbed around the edge of a glass | L – loop |
| 036 | Funk Bass1 | Electric bass | S – loop |

| No. | Wave name | Remarks | Type |
|-----|------------|---|----------|
| 037 | Funk Bass2 | Electric bass with bright low range | S – loop |
| 038 | Strat Sust | Single coil electric guitar | S – loop |
| 039 | Harp Harm | Harp harmonic | S – loop |
| 040 | Full Organ | Electric organ with doubled 16 feet | S – loop |
| 041 | Full Draw | Full drawbar electric organ | S – loop |
| 042 | Doo | Sound with many partials and pipe organ-like attack | S – loop |
| 043 | ZZZ Voz | Hard, noisy voice | L – loop |
| 044 | Org Vox | Soft, noisy voice | L – loop |
| 045 | Male Vox | Metalic voice | L – loop |
| 046 | Kalimba | Kalimba (ethnic instrument) with sharp attack | S – loop |
| 047 | Xylo | Xylophone | S – loop |
| 048 | Marim Wave | Marimba | S – loop |
| 049 | Log Drum | Log Drum (ethnic instrument) | S – loop |
| 050 | AgogoBells | Agogo bells | S – loop |
| 051 | Bottle Hit | Sound of hitting a small bottle | S – loop |
| 052 | Gamelan 1 | Metallic percussion | S – loop |
| 053 | Gamelan 2 | Hard metallic percussion | S – loop |
| 054 | Gamelan 3 | Soft metallic percussion | S – loop |
| 055 | Table | Tabla (ethnic instrument) | S – loop |
| 056 | Pole Ip | Rough sound of hitting an earthen pipe | L – loop |
| 057 | Pluck Harp | Harp with strong attack | S – loop |
| 058 | Nylon Str | Nylon string classical guitar | S – loop |
| 059 | Hooky | Many plucked strings | S – loop |
| 060 | Muters | Muted electric guitar | S – loop |
| 061 | Klack Wave | Thick sound with sharp attack | S – loop |
| 062 | Crystal | Transparent sound | S – loop |
| 063 | Digi Bell | Hard bell | S – loop |
| 064 | FingerBell | Sound of hitting a small bell | L – loop |
| 065 | Digi Chime | Hard chime | S – loop |
| 066 | Bell Wave | Soft bell sound | S – loop |
| 067 | Org Bell | Bell sound with many high partials | S – loop |
| 068 | Scrape Gut | Sound of scraped strings | S – loop |
| 069 | Strat Atk | Attack sound of electric guitar played with a pick | S – loop |
| 070 | Hellow Bs | Synth bass with thick attack | S – loop |
| 071 | Piano Atk | Acoustic piano including hammer sound | S – loop |
| 072 | EP Hard | Electric piano | S – loop |

WAVEFORM LIST

| No. | Wave name | Remarks | Type |
|-----|------------|---|----------|
| 073 | Clear Keys | Electric piano processed to an organ-type sound | S – loop |
| 074 | EP Distone | Distorted electric piano | S – loop |
| 075 | Flute Push | Tongued flute sound | O – shot |
| 076 | Shami | Attack of shamisen sound | O – shot |
| 077 | Wood Crak | Sound with sharp attack like a slapped board | O – shot |
| 078 | Klmba Atk | Attack sound of a kalimba | O – shot |
| 079 | Block | Attack sound of a wood block | O – shot |
| 080 | Org Atk 1 | Low range organ attack sound | O – shot |
| 081 | Org Atk 2 | High range organ attack sound | O – shot |
| 082 | Cowbell | Attack of a cowbell | O – shot |
| 083 | Sm Metal | Muted attack of a cowbell | O – shot |
| 084 | StrikePole | Sound of a struck metal rod | O – shot |
| 085 | Pizz | Pizzicato strings | O – shot |
| 086 | Switch | Mechanical noise of a power switch | O – shot |
| 087 | Tuba Slap | Sound of a tuba valve (piston) | O – shot |
| 088 | Plink | Very short metallic noise | O – shot |
| 089 | Plunk | Very short bell-type noise | O – shot |
| 090 | EP Atk | Electric piano attack sound | O – shot |
| 091 | TVF_Trig | An impulse-type sound usable as a trigger | O – shot |
| 092 | Flute Tone | Flute harmonics | S – loop |
| 093 | Pan Pipe | A pan pipe with a lot of breath noise | L – loop |
| 094 | BottleBlow | Sound of blown bottle | L – loop |
| 095 | Shaku Atk | Shakuhachi blown tongued-style | L – loop |
| 096 | FlugelWave | Flugel horn | S – loop |
| 097 | French | French horn | S – loop |
| 098 | WhiteNoise | White noise | S – loop |
| 099 | Pink Noise | Pink noise | S – loop |
| 100 | Pitch Wind | A pitched, dark-feeling wind sound | L – loop |
| 101 | Vox Noise1 | White noise with little sense of pitch | L – loop |
| 102 | Vox Noise2 | White noise with greater sense of pitch | L – loop |
| 103 | CrunchWind | Sound similar to braking noise | L – loop |
| 104 | ThroatWind | Sound similar to steam noise | L – loop |
| 105 | Metal Wind | Metallic noise | L – loop |
| 106 | Windago | Noise with agogo bell nuance | L – loop |
| 107 | Anklungs | Many wood scraps sounding together | L – loop |
| 108 | Wind Chime | Many metallic scraps sounding together | L – loop |

PARAMETER LIST

○ Patch parameter

◇ Common

| | Parameter | Display | Values |
|-------------|-----------------------------|----------------------|------------------------------|
| | Patch Name | Patch name | (16 Character ASCII) |
| | Patch Level | Patch level | 0 ~ 100 |
| | Key Range A (Low/High) | Range A (L :/H :) | C - 1 - G9 |
| | Key Range B (Low/High) | Range B (L :/H :) | C - 1 - G9 |
| | Key Range C (Low/High) | Range C (L :/H :) | C - 1 - G9 |
| | Key Range D (Low/High) | Range D (L :/H :) | C - 1 - G9 |
| | Solo Switch | ----- * 1 | OFF, ON |
| | Solo Legato | Solo legato | OFF, ON |
| | Portamento Switch | ----- * 1 | OFF, ON |
| | Portamento Mode | Portamento mode | NORMAL, LEGATO |
| | Portamento Time | Portamento time | 0 - 100 |
| | Bender Range | Bender range D : U : | (DOWN) 0 - 48 (UP) 0 - 12 |
| | Aftertouch Bend Sensitivity | A-touch bend sens | - 36, - 24, - 12 - + 12 |
| | Layer tone | ----- * 1 | A - A + B + C + D |
| | Active Tone | ----- * 1 | A - A + B + C + D |
| MIDI Tx | Key Mode | Key mode | SPLIT, DUAL, WHOLE |
| | Split Point | Split point | C - 1 - C#8 |
| | Channel | Channel L : U : | 1 - 16 |
| | Program Change Number | Prog chg# L : U : | 1 - 128 |
| | Hold Mode | Hold mode | UPPER, LOWER, BOTH |
| (Equalizer) | Low Frequency | Low freq | 200Hz, 400Hz |
| | Low Gain | Low gain | - 15 - + 15dB |
| | Mid Frequency | Mid freq | 200Hz - 8kHz * 2 |
| | Mid Q | Mid Q | 0.3 ~ 9.0 * 3 |
| | Mid Gain | Mid gain | - 15 - + 15dB |
| | High Frequency | High freq | 4kHz, 8kHz |

* 1 : Use the switch to set.

* 2 : 200,250,315,400,500,630,800,1k,1.25k,106k,2k,
2.5k,3.15k,4k,5k,6.3k,8k (unit : Hz)

* 3 : 0.5,1.0,2.0,4.0,9.0

PARAMETER LIST

Patch/Effects

◇ Effects

| | Parameter | Display | Values |
|--------------------|------------------|----------------|--|
| | Sequence A | Sequence A | DS---PH---SP---EH |
| | Switch A | Switch A | (ON), (OFF) |
| | Sequence B | Sequence B | CH---DL---RV |
| | Switch B | Switch B | (ON), (OFF) |
| | Effect Balance B | Balance B | Dry : EFF 0 : 100—100 : 0 |
| (Distortion Setup) | Type | Type | MELLOW DRIVE, OVERDRIVE, CRY DRIVE, MELLOW DIST, LIGHT DIST, FAT DIST, FUZZ DIST |
| | Drive | Drive | 0—100 |
| | Level | Level | 0—100 |
| (Phaser Setup) | Manual | Manual | 50Hz—15.0 kHz |
| | Rate | Rate | 0.1—10 Hz |
| | Depth | Depth | 0—100 |
| | Resonance | Resonance | 0—100 |
| | Level | Level | 0—100 |
| (Spectrum Setup) | Band 1 Control | Band 1 control | - 15— + 15 |
| | Band 2 Control | Band 2 control | - 15— + 15 |
| | Band 3 Control | Band 3 control | - 15— + 15 |
| | Band 4 Control | Band 4 control | - 15— + 15 |
| | Band 5 Control | Band 5 control | - 15— + 15 |
| | Band 6 Control | Band 6 control | - 15— + 15 |
| | Band Width | Band width | 1—5 |
| (Enhancer Setup) | Sensitivity | Sens | 0—100 |
| | Mix | Mix | 0—100 |

To next page

| | Parameter | Display | Values |
|----------------|------------------------|---------------------|--|
| (Chorus Setup) | Rate | Rate | 0.1—10Hz |
| | Depth | Depth | 0—100 |
| | Delay Time | Delay time | 0.1—50ms * 4 |
| | Feedback | Feedback | - 98— + 98 % |
| | Level | Level | 0—100 |
| (Delay Setup) | Center Tap | Center tap | 0.1—600ms * 5 |
| | Center Level | Center level | 0—100 |
| | Left Tap | Left tap | 0.1—600ms * 5 |
| | Left Level | Left level | 0—100 |
| | Right Tap | Right tap | 0.1—600ms * 5 |
| | Right Level | Right level | 0—100 |
| | Feedback | Feedback | - 98— + 98 % |
| (Reverb Setup) | Type | Type | ROOM1/2, HALL1/2/3, 4, GATE, REVERSE, FLYING 1/2 |
| | Pre Delay Time | Pre delay time | 0—120ms |
| | Early Reflection Level | Early ref level * 6 | 0—100 |
| | High Frequency Damp | HF damp * 6 | 500Hz—15kHz |
| | Time | Time * 7 | 0.1s—20s |
| | Level | Level | 0 ~ 100 |

* 4 : 0.1~5ms (0.1ms),5~10ms (0.5ms),
10~50ms (1ms)

* 5 : 0.1~5ms (0.1ms),5~10ms (0.5ms),
10~40ms (1ms),40~100ms (10ms),
200~600ms (20ms)

* 6 : The selection of GATE, REVERSE, and FLYING
1/2 is invalid in the TYPE parameter.

* 7 : When using ROOM 1/2 and HALL 1/2/3/4,
the times are :

0.1—10s (0.1s) and 10—20s (0.5s).

When using GATE, REVERSE, and FLYING 1/2,
the times are :

5—500ms.

PARAMETER LIST

Patch/Tone

◇ Tone

| | Parameter | Display | Values |
|------------------|---------------------------|------------------|-------------------------|
| (Common) | Hold Control | Hold ctrl | OFF, ON |
| | Velocity Curve | Velo curve | 1, 2, 3, 4 |
| (LFO 1/2) | Rate | Rate | 0—100 |
| | Delay | Delay | 0—100, REL |
| | Fade | Fade | - 50— + 50 |
| | Waveform | Waveform | TRI, SAW, SQU, S/H, RND |
| | Offset | Offset | -, 0, + |
| | Key Trigger | Key trig | OFF, ON |
| (WG) | Wave Source | Wave source | INT, CRD |
| | Wave form | Waveform | 1—256 |
| | Pitch Coarse | Pitch coarse | - 48 — + 48 |
| | Pitch Fine | Pitch fine | - 50— + 50 |
| | Pitch Random | Pitch random | 0—100 |
| | Pitch Key Follow | Pitch KF | - 100—200 % |
| | Bender Switch | Bender | OFF, ON |
| | Aftertouch Bend Switch | Atouch bend | OFF, ON |
| | LFO1 Modulation | LFO 1 sens depth | - 50— + 50 |
| | LFO2 Modulation | LFO 2 sens depth | - 50— + 50 |
| | Lever Modulation | Lever sens | LFO1 (50)—LFO2 (50) |
| | Aftertouch Modulation | Atouch sens | LFO1 (50)—LFO2 (50) |
| (Pitch Envelope) | Velocity Sensitivity | Velo sens | - 50— + 50 |
| | Time Velocity Sensitivity | Time velo | - 50— + 50 |
| | Time Key Follow | Time KF | - 10— + 10 |
| | Level 0 | Level 0 | - 50— + 50 |
| | Time 1 | Time 1 | 0—100 |
| | Level 1 | Level 1 | - 50— + 50 |
| | Time 2 | Time 2 | 0—100 |
| | Time 3 | Time 3 | 0—100 |
| | Level 2 | Level 2 | - 50— + 50 |

To next page

PARAMETER LIST

Patch/Tone

| | Parameter | Display | Values |
|----------------|-------------------------------|-------------|-------------------|
| (TVF) | Filter Mode | Mode | HPF, BPF, LPF |
| | Cutoff Frequency | Cutoff freq | 0—100 |
| | Resonance | Resonance | 0—100 |
| | Cutoff Key Follow | Cutoff KF | - 100— + 150 |
| | Aftertouch Cutoff Sensitivity | Atouch sens | - 50— + 50 |
| | LFO Select | LFO select | LFO1, LFO2 |
| | LFO Depth | LFO depth | - 50— + 50 |
| (TVF Envelope) | TVF Envelope Depth | ENV depth | - 50— + 50 |
| | Velocity Sensitivity | Velo sens | - 50— + 50 |
| | Time Velocity Sensitivity | Time velo | - 50— + 50 |
| | Time Key Follow | Time KF | - 10— + 10 |
| | Time 1 | Time 1 | 0—100 |
| | Level 1 | Level 1 | 0—100 |
| | Time 2 | Time 2 | 0—100 |
| | Level 2 | Level 2 | 0—100 |
| | Time 3 | Time 3 | 0—100 |
| | Level 3 | Level 3 | 0—100 |
| | Time 4 | Time 4 | 0—100 |
| | Level 4 | Level 4 | 0—100 |
| (TVA) | Level | Level | 0—100 |
| | Bias Direction | Bias dir | UP, LOW, UP & LOW |
| | Bias Point | Bias point | C - 1—G9 |
| | Bias Level | Bias level | - 10— + 10 |
| | Aftertouch Sensitivity | Atouch sens | - 50— + 50 |
| | LFO Select | LFO select | LFO1, LFO2 |
| | LFO Depth | LFO depth | - 50— + 50 |

To next page

PARAMETER LIST

Patch/Tone

| | Parameter | Display | Values |
|-------------------|---------------------------|-----------|------------|
| (TVA Envelope) | Velocity Sensitivity | Velo sens | - 50— + 50 |
| | Time Velocity Sensitivity | Time velo | - 50— + 50 |
| | Time Key Follow | Time KF | - 10— + 10 |
| | Time 1 | Time 1 | 0—100 |
| | Level 1 | Level 1 | 0—100 |
| | Time 2 | Time 2 | 0—100 |
| | Level 2 | Level 2 | 0—100 |
| | Time 3 | Time 3 | 0—100 |
| | Level 3 | Level 3 | 0—100 |
| | Time 4 | Time 4 | 0—100 |

○ Multi parameter

◇ Part

| Parameter | Display | Values |
|----------------------|------------------|-----------------------------------|
| Patch Select | ----- * 1 | I-11-C-88 |
| MIDI Receive Channel | MIDI Rx ch | 1-16, OFF |
| Level | Level | 0-100 |
| Pan | Pan * 8 | L30-30R |
| Output Assign | Output assign | MIX, DIRECT |
| Effect Mode | Effect mode * 8 | DRY, REV, CHO + REV, DLY + REV |
| Effect Level | Effect level * 8 | OFF, ON |

* 1 : Use the switch to set.

* 8 : Parameters invalid for the Special Part.

◇ Special setup

| | Parameter | Display | Values |
|-------------|-----------------------------|----------------------|----------------------------------|
| (Common) | Bender Range | Bender range D : U : | (DOWN) 0-48, (UP) 0-12 |
| | Aftertouch Bend Sensitivity | Atouch bend | -36, -24, -12-+12 |
| (Equalizer) | Low Frequency | Low freq | 200Hz, 400Hz |
| | Low Gain | Low gain | -15-+15dB |
| | Mid Frequency | Mid freq | 200Hz-8kHz * 2 |
| | Mid Q | Mid Q | 0.5-9.0 * 3 |
| | Mid Gain | Mid gain | -15-+15dB |
| | High Frequency | High freq | 4kHz, 8kHz |
| (Key Setup) | Name | Name | (10 Charactor ASCII) |
| | Mute Group | Mute group | OFF, A, B, C, D, E, F, G, H |
| | Envelope Mode | ENV mode | NORMAL, NO SUSTAIN |
| | Pan | Pan | L30-30R |
| | Effect Mode | Effect mode | DRY, REV, CHO + REV DLY + REV |
| | Effect Level | Effect level | 0-100 |
| | ## Tone Parameter ## | ----- * 9 | ----- |

* 2 : 200,250,315,400,500,630,800,1k,1.25k,1.6k,2k,2.5k,3.15k,4k,5k,6.3k,8k (Unit : Hz)

* 3 : 0.5,1.0,2.0,4.0,9.0

* 9 : Refer to "Tone" in Patch parameter.

PARAMETER LIST

Multi/Effects

◇ Effects

| | Parameter | Display | Values |
|----------------|------------------------|---------------------|--|
| (Chorus Setup) | Rate | Rate | 0.1—10Hz |
| | Depth | Depth | 0—100 |
| | Decay Time | Delay time | 0.1—50ms * 4 |
| | Feedback | Feedback | - 98— + 98 % |
| | Level | Level | 0—100 |
| (Delay Setup) | Center Tap | Center tap | 0.1—600ms * 5 |
| | Center Level | Center level | 0—100 |
| | Left Tap | Left tap | 0.1—600ms * 5 |
| | Left Level | Left level | 0—100 |
| | Right Tap | Right tap | 0.1—600ms * 5 |
| | Right Level | Right level | 0—100 |
| | Feedback | Feedback | - 98— + 98 % |
| (Reverb Setup) | Type | Type | ROOM1/2 HALL1/2/3/4, GATE, REVERSE, FLYING 1/2 |
| | Pre Delay Time | Pre delay time | 0—120ms |
| | Early Reflection Level | Early ref level * 6 | 0—100 |
| | High Frequency Damp | HF damp * 6 | 500Hz—15kHz |
| | Time | Time * 7 | 0.1s—20s |
| | Level | Level | 0—100 |

* 4 : 0.1—5ms (0.1ms), 5—10ms (0.5ms),
10—50ms (1ms)

* 5 : 0.1—5ms (0.1ms), 5—10ms (0.5ms),
10—40ms (1ms), 40—200ms (10ms),
200—600ms (20ms)

* 6 : The selection of GATE, REVERSE, and FLYING
1/2 is invalid in the TYPE parameter.

* 7 : When using ROOM 1/2 and HALL 1/2/3/4,
the times are :

0.1—10s (0.1s) and 10—20s (0.5s).

When using GATE, REVERSE, and FLYING 1/2,
the times are :

5—500ms.

○ System parameter

◇ Tune/Function

| Parameter | Display | Values |
|----------------------|----------------|--------------------|
| Master Tune | Master tune | 427.5Hz—452.9Hz |
| Transpose Switch | ----- * 1 | OFF, ON |
| Transpose Value | Transpose | - 12— + 12 |
| External Control | Ext control | VOL, MOD, PAN, AFT |
| Treble Control | Treble control | - 5— + 5 |
| Mid Control | Mid control | - 5— + 5 |
| Bass Control | Bass control | - 5— + 5 |
| Chorus master switch | Chorus switch | OFF, ON |
| Delay master switch | Delay switch | OFF, ON |
| Reverb master switch | Reverb switch | OFF, ON |

* 1 : Setting by switches

◇ MIDI

| Parameter | Display | Values |
|-----------------------------|-----------------|---|
| Local Control | Local control | OFF, ON |
| Unit Number | Unit number | 17—32 |
| Transmit Channel | Tx channel | OFF, 1—16, RX CH (PART), PATCH |
| Receive Channel | Rx channel * 10 | 1—16, OFF |
| Program Change Transmission | Tx program chg | OFF, NORMAL, PATCH |
| Program Change Reception | Rx program chg | OFF, ON |
| Aftertouch Transmission | Tx A-touch | OFF, ON |
| Aftertouch Reception | Rx A-touch | OFF, ON |
| Volume Reception | Rx volume | OFF, ON |
| Breath Reception | Rx breath | OFF, VOL, MOD, AFT, V & M, V & A, M & A, ALL |
| Exclusive Reception | Rx exclusive | OFF, ON - 1, ON - 2 |
| Edit Transmission | Tx edit data | OFF, ON |

* 10 : Displayed in Single mode

BLANK CHARTS

[PATCH]

| PATCH COMMON | | | | | | | | | | PATCH EFFECTS | | | | | | | | | | | |
|--------------|--------------|---------|-----------|-------------|------------|-----------|------------|------|---------|---------------------|-------|---------|---------|----------|---------------------|---------|---------|------|----------|-------|--|
| Patch Name | | | | | Patch Name | | | | | Group A sequence/SW | | | | | Group B Sequence/SW | | | | | | |
| - | | | | | - | | | | | → → → → | | | | | → → → → | | | | | | |
| Level | Bender | | A touch | | Solo | | Portamento | | | Distortion | | | | | Phaser | | | | | | |
| | Down | Up | bend sens | | SW | Legato | SW | Mode | Time | Type | Drive | Level | Manual | Rate | Depth | Reso | Mix | | | | |
| Key Range | | | | | | | | | | Spectrum | | | | | Enhancer | | | | | | |
| Tone A | | Tone B | | Tone C | | Tone D | | | Band1 | Band2 | Band3 | Band4 | Band5 | Band6 | Width | Sens | Mix | | | | |
| Low | High | Low | High | Low | High | Low | High | High | | | | | | | | | | | | | |
| EQ | | | | | | | | | | Dry/Effect | | | | | Chorus | | | | | | |
| L-freq | L-gain | M-freq | Mid-Q | M-gain | H-freq | H-gain | | | | Balance B | | Rate | Depth | D-time | Feedback | Level | | | | | |
| Hz | dB | Hz | | dB | Hz | dB | | | | D: | E: | Hz | | ms | % | | | | | | |
| MIDI Tx | | | | | | | | | | Delay | | | | | Reverb | | | | | | |
| Mode | Split Point | Channel | | Prog change | | Hold mode | C-tap | | C-level | | L-tap | | L-level | | R-tap | | R-level | | Feedback | | |
| | | Lower | Upper | Lower | Upper | | ms | | ms | | ms | | ms | | ms | | % | | | | |
| TONES | | | | | | | | | | Type | | Pre dly | | ER level | | HF damp | | Time | | Level | |
| | | A | | B | | C | | D | | ms | | Hz | | s | | | | | | | |
| Layer | | A | | B | | C | | D | | ms | | Hz | | s | | | | | | | |
| Active | | | | | | | | | | | | | | | | | | | | | |
| COM | Hold control | | | | | | | | | | | | | | | | | | | | |
| | Velo curve | | | | | | | | | | | | | | | | | | | | |
| LFO 1 | Rate | | | | | | | | | | | | | | | | | | | | |
| | Delay | | | | | | | | | | | | | | | | | | | | |
| LFO 2 | Fade | | | | | | | | | | | | | | | | | | | | |
| | Waveform | | | | | | | | | | | | | | | | | | | | |
| WG | Offset | | | | | | | | | | | | | | | | | | | | |
| | Key trigger | | | | | | | | | | | | | | | | | | | | |
| TVA | Rate | | | | | | | | | | | | | | | | | | | | |
| | Delay | | | | | | | | | | | | | | | | | | | | |
| TVA ENV | Fade | | | | | | | | | | | | | | | | | | | | |
| | Waveform | | | | | | | | | | | | | | | | | | | | |
| TVA | Offset | | | | | | | | | | | | | | | | | | | | |
| | Key trigger | | | | | | | | | | | | | | | | | | | | |
| TVA ENV | Pitch coarse | | | | | | | | | | | | | | | | | | | | |
| | Pitch fine | | | | | | | | | | | | | | | | | | | | |
| TVA ENV | Pitch random | | | | | | | | | | | | | | | | | | | | |
| | Pitch KF | | | | | | | | | | | | | | | | | | | | |
| TVA ENV | A touch bend | | | | | | | | | | | | | | | | | | | | |
| | Bender | | | | | | | | | | | | | | | | | | | | |
| TVA ENV | Waveform | | | | | | | | | | | | | | | | | | | | |
| | Wave source | | | | | | | | | | | | | | | | | | | | |
| TVA ENV | A touch sens | | | | | | | | | | | | | | | | | | | | |
| | LFO 1 depth | | | | | | | | | | | | | | | | | | | | |
| TVA ENV | LFO 2 depth | | | | | | | | | | | | | | | | | | | | |
| | Lever sens | | | | | | | | | | | | | | | | | | | | |
| TVA ENV | Velo sens | | | | | | | | | | | | | | | | | | | | |
| | Time velo | | | | | | | | | | | | | | | | | | | | |
| TVA ENV | Time KF | | | | | | | | | | | | | | | | | | | | |
| | Level 0 | | | | | | | | | | | | | | | | | | | | |
| TVA ENV | Time 1 | | | | | | | | | | | | | | | | | | | | |
| | Level 1 | | | | | | | | | | | | | | | | | | | | |
| TVA ENV | Time 2 | | | | | | | | | | | | | | | | | | | | |
| | Level 2 | | | | | | | | | | | | | | | | | | | | |
| TVA ENV | Time 3 | | | | | | | | | | | | | | | | | | | | |
| | Level 2 | | | | | | | | | | | | | | | | | | | | |
| TVA ENV | Time 4 | | | | | | | | | | | | | | | | | | | | |
| | Level 2 | | | | | | | | | | | | | | | | | | | | |

【MULTI-PART】

| | Patch | MIDI Rx ch | Level | Pan | Output | Eff mode | Eff level |
|---------|-------|------------|-------|------|--------|----------|-----------|
| Part 1 | | | | | | | |
| Part 2 | | | | | | | |
| Part 3 | | | | | | | |
| Part 4 | | | | | | | |
| Part 5 | | | | | | | |
| Special | | | | **** | | ***** | ***** |

【MULTI-EFFECTS】

| Chorus | | | | | | |
|--------|-----------|----------|----------|-------|---------|----------|
| Rate | Depth | Dly time | Feedback | Level | | |
| Hz | | ms | % | | | |
| Delay | | | | | | |
| C-tap | C-level | L-tap | L-level | R-tap | R-level | Feedback |
| ms | | ms | | ms | | % |
| Reverb | | | | | | |
| Type | Pre delay | ER level | HF damp | Time | Level | |
| | ms | | Hz | s | | |

【MULTI-SPECIAL SETUP / Common】

| Bender range | Atouch bend |
|--------------|-------------|
| | |

【MULTI-SPECIAL SETUP / EQ】

| EQ | | | | | | |
|----------|----------|----------|-------|----------|-----------|-----------|
| Low freq | Low gain | Mid gain | Mid Q | Mid gain | High freq | High gain |
| Hz | dB | Hz | | dB | Hz | dB |

【MULTI-SPECIAL SETUP / Key】

| | Note number | Key name | Mute group | ENV mode | pan | EFF mode | EFF level |
|----|-------------|----------|------------|----------|-----|----------|-----------|
| C3 | 36 | 37 | | | | | |
| | 38 | | | | | | |
| | 40 | 39 | | | | | |
| | 41 | | | | | | |
| | 43 | 42 | | | | | |
| | 45 | 44 | | | | | |
| | 47 | 46 | | | | | |
| | C3 | 48 | 49 | | | | |
| 50 | | | | | | | |
| 52 | | 51 | | | | | |
| 53 | | | | | | | |
| 55 | | 54 | | | | | |
| 57 | | 56 | | | | | |
| 59 | | 58 | | | | | |
| C4 | | 60 | 61 | | | | |
| | 62 | | | | | | |
| | 64 | 63 | | | | | |
| | 65 | | | | | | |
| | 67 | 66 | | | | | |
| | 69 | 68 | | | | | |
| | 71 | 70 | | | | | |
| | C5 | 72 | 73 | | | | |
| 74 | | | | | | | |
| 76 | | 75 | | | | | |
| 77 | | | | | | | |
| 79 | | 78 | | | | | |
| 81 | | 80 | | | | | |
| 83 | | 82 | | | | | |
| C6 | | 84 | 85 | | | | |
| | 86 | | | | | | |
| | 88 | 87 | | | | | |
| | 89 | | | | | | |
| | 91 | 90 | | | | | |
| | 93 | 92 | | | | | |
| | 95 | 94 | | | | | |
| | C7 | 96 | | | | | |

【MULTI-SPECIAL SETUP / KEY / TONE】

| Key (note) () | | Tone name : | |
|-------------------|--|----------------|--|
| COMMON | | TVF | |
| Hold control | | Filter mode | |
| Velo curve | | Cutoff freq | |
| LFO 1 | | Resonance | |
| Rate | | ENV depth | |
| Delay | | Cutoff KF | |
| Fade | | LFO select | |
| Waveform | | LFO depth | |
| Offset | | Atouch sens | |
| Key trig | | TVF ENV | |
| LFO 2 | | Velo sens | |
| Rate | | Time velo | |
| Delay | | Time KF | |
| Fade | | Time 1 | |
| Waveform | | Level 1 | |
| Offset | | Time 2 | |
| Key trig | | Level 2 | |
| WG | | Time 3 | |
| Pitch coarse | | Sus level | |
| Pitch fine | | Time 4 | |
| Pitch random | | Level 4 | |
| Pitch KF | | TVA | |
| Atouch bend | | Level | |
| Bender | | Bias direction | |
| Waveform | | Bias point | |
| Wave source | | Bias level | |
| Atouch sens | | Atouch sens | |
| LFO 1 depth | | LFO select | |
| LFO 2 depth | | LFO depth | |
| Lever sens | | TVA ENV | |
| Pitch ENV | | Velo sens | |
| Velo sens | | Time velo | |
| Time velo | | Time KF | |
| Time KF | | Time 1 | |
| Level 0 | | Level 1 | |
| Time 1 | | Time 2 | |
| Level 1 | | Level 2 | |
| Time 2 | | Time 3 | |
| Time 3 | | Sus level | |
| Level 2 | | Time 4 | |

【TUNE/FUNCTION】

| Master tune | Transpose | | Ext control | Mix.out filter | | |
|----------------------|-----------|--------|-------------|----------------|-----|------|
| | SW | Value | | Treble | Mid | Bass |
| Hz | | | | | | |
| Effect master switch | | | | | | |
| Chorus | Delay | Reverb | | | | |
| | | | | | | |

【MIDI】

| Local | Unit # | Channel | | Prog change | | Aftertouch | |
|-----------|-----------|--------------|--------------|-------------|----|------------|----|
| | | Tx ch | Rx ch | Tx | Rx | Tx | Rx |
| | | | | | | | |
| Rx volume | Rx breath | Rx exclusive | Tx edit data | | | | |
| | | | | | | | |

Roland Exclusive Messages

1. Data Format for Exclusive Messages

Roland's MIDI implementation uses the following data format for all exclusive messages (type IV) :

| Byte | Description |
|--------|--------------------------|
| F0H | Exclusive status |
| 41H | Manufacturer ID (Roland) |
| DEV | Device ID |
| MDL | Model ID |
| CMD | Command ID |
| [BODY] | Main data |
| F7H | End of exclusive |

MIDI status : F0H, F7H

An exclusive message must be flanked by a pair of status codes, starting with a Manufacturer-ID immediately after F0H (MIDI version 1.0).

Manufacturer ID : 41H

The Manufacturer-ID identifies the manufacturer of a MIDI instrument that triggers an exclusive message. Value 41H represents Roland's Manufacturer-ID.

Device ID : DEV

The Device-ID contains a unique value that identifies the individual device in the multiple implementation of MIDI instruments. It is usually set to 00H - 0FH, a value smaller by one than that of a basic channel, but value 00H - 1FH may be used for a device with multiple basic channels.

Model ID : MDL

The Model-ID contains a value that uniquely identifies one model from another. Different models, however, may share an identical Model-ID if they handle similar data.

The Model-ID format may contain 00H in one or more places to provide an extended data field. The following are examples of valid Model-IDs, each representing a unique model :

01H
 02H
 03H
 00H, 01H
 00H, 02H
 00H, 00H, 01H

Command ID : CMD

The Command-ID indicates the function of an exclusive message.

The Command-ID format may contain 00H in one or more places to provide an extended data field. The following are examples of valid Command-IDs, each representing a unique function :

01H
 02H
 03H
 00H, 01H
 00H, 02H
 00H, 00H, 01H

Main data : BODY

This field contains a message to be exchanged across an interface. The exact data size and contents will vary with the Model-ID and Command-ID.

2. Address mapped Data Transfer

Address mapping is a technique for transferring messages conforming to the data format given in Section 1. It assigns a series of memory-resident records-waveform and tone data, switch status, and parameters, for example-to specific locations in a machine-dependent address space, thereby allowing access to data residing at the address a message specifies.

Address-mapped data transfer is therefore independent of models and data categories. This technique allows use of two different transfer procedures: one-way transfer and handshake transfer.

One-way transfer procedure (See Section 3 for details.)

This procedure is suited for the transfer of a small amount of data. It sends out an exclusive message completely independent of a receiving device status.

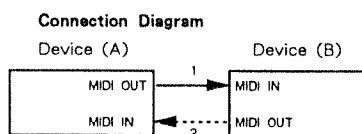

Connection at point 2 is essential for "Request data" procedures. (See Section 3.)

Handshake transfer procedure (This device does not cover this procedure)

This procedure initiates a predetermined transfer sequence (handshaking) across the interface before data transfer takes place. Handshaking ensures that reliability and transfer speed are high enough to handle a large amount of data.

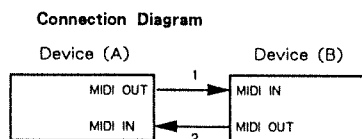

Connection at points 1 and 2 is essential.

Notes on the above two procedures

- * There are separate Command-IDs for different transfer procedures.
- * Devices A and B cannot exchange data unless they use the same transfer procedure, share identical Device-ID and Model ID, and are ready for communication.

Roland Exclusive Messages

3. One-way Transfer Procedure

This procedure sends out data all the way until it stops and is used when the messages are so short that answerbacks need not be checked.

For long messages, however, the receiving device must acquire each message in time with the transfer sequence, which inserts intervals of at least 20 milliseconds in between.

Types of Messages

| Message | Command ID |
|----------------|------------|
| Request data 1 | RQ1 (11H) |
| Data set 1 | DT1 (12H) |

#

Request data #1 : RQ1 (11H)

This message is sent out when there is a need to acquire data from a device at the other end of the interface. It contains data for the address and size that specify designation and length, respectively, of data required.

On receiving an RQ1 message, the remote device checks its memory for the data address and size that satisfy the request.

If it finds them and is ready for communication, the device will transmit a "Data set 1 (DT1)" message, which contains the requested data. Otherwise, the device will send out nothing.

| Byte | Description |
|------|--------------------------|
| F0H | Exclusive status |
| 41H | Manufacturer ID (Roland) |
| DEV | Device ID |
| MDL | Model ID |
| 11H | Command ID |
| aaH | Address MSB |
| ⋮ | ⋮ |
| ⋮ | ⋮ |
| ⋮ | ⋮ |
| ssH | Size MSB |
| ⋮ | ⋮ |
| ⋮ | ⋮ |
| ⋮ | ⋮ |
| sum | Check sum |
| F7H | End of exclusive |

- * The size of the requested data does not indicate the number of bytes that will make up a DT1 message, but represents the address fields where the requested data resides.
- * Some models are subject to limitations in data format used for a single transaction. Requested data, for example, may have a limit in length or must be divided into predetermined address fields before it is exchanged across the interface.
- * The same number of bytes comprises address and size data, which, however, vary with the Model-ID.
- * The error checking process uses a checksum that provides a bit pattern where the least significant 7 bits are zero when values for an address, size, and that checksum are summed.

Data set 1 : DT1 (12H)

This message corresponds to the actual data transfer process. Because every byte in the data is assigned a unique address, a DT1 message can convey the starting address of one or more data as well as a series of data formatted in an address-dependent order.

The MIDI standards inhibit non-real time messages from interrupting an exclusive one. This fact is inconvenient for the devices that support a "soft-through" mechanism. To maintain compatibility with such devices, Roland has limited the DT1 to 256 bytes so that an excessively long message is sent out in separate segments.

| Byte | Description |
|------|--------------------------|
| F0H | Exclusive |
| 41H | Manufacturer ID (Roland) |
| DEV | Device ID |
| MDL | Model ID |
| 12H | Command ID |
| aaH | Address MSB |
| ⋮ | ⋮ |
| ⋮ | ⋮ |
| ⋮ | ⋮ |
| ddH | Data LSB |
| ⋮ | ⋮ |
| ⋮ | ⋮ |
| sum | Check sum |
| F7H | End of exclusive |

- * A DT1 message is capable of providing only the valid data among those specified by an RQ1 message.
- * Some models are subject to limitations in data format used for a single transaction. Requested data, for example, may have a limit in length or must be divided into predetermined address fields before it is exchanged across the interface.
- * The number of bytes comprising address data varies from one Model-ID to another.
- * The error checking process uses a checksum that provides a bit pattern where the least significant 7 bits are zero when values for an address, size, and that checksum are summed.

Example of Message Transactions

- Device A sending data to Device B
Transfer of a DT1 message is all that takes place.

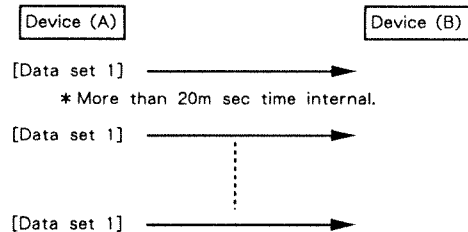

- Device B requesting data from Device A
Device B sends an RQ1 message to Device A. Checking the message, Device A sends a DT1 message back to Device B.

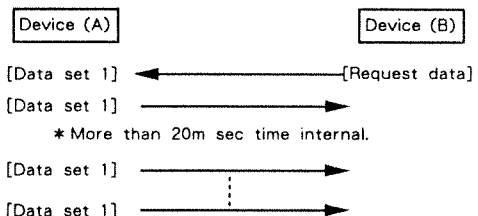

1. RECOGNIZED RECIEVE DATA

■ Channel voice messages

● Note off

| Status | Second | Third |
|--------|--------|-------|
| 8nH | kkH | vvH |
| 9nH | kkH | 00H |

n=MIDI channel No. :0H - FH (0 - 15) 0=ch.1 15=ch.16
 kk=Note No. :00H - 7FH (0 - 127)***SINGLE, MULTI PART 1-5
 24H - 60H (36 - 96)***MULTI SPECIAL PART
 vv=Velocity :00H - 7FH (0 - 127)

*Velocity is used as on-velocity for retriggering in the solo mode.
 It is effective in the SINGLE mode and for PART 1 to 5 in the MULTI mode.
 This is not effective for SPECIAL PART and modes other than solo mode.

● Note on

| Status | Second | Third |
|--------|--------|-------|
| 9nH | kkH | vvH |

n=MIDI channel No. :0H - FH (0 - 15) 0=ch.1 15=ch.16
 kk=Note No. :SINGLE, MULTI PART1 - 5 00H - 7FH (0 - 127)
 MULTI SPECIAL PART 24H - 60H (36 - 96)
 vv=Velocity :01H - 7FH (1 - 127)

● Control change

○ Modulation

| Status | Second | Third |
|--------|--------|-------|
| BnH | 01H | vvH |

n=MIDI channel No. :0H - FH (0 - 15) 0=ch.1 15=ch.16
 vv=Modulation :00H - 7FH (0 - 127)

*When receiving this message, the JD-800 activates bivratation effect amount of which is directly propòrtional to the lever sens settings in tone parameters.

○ Breath

| Status | Second | Third |
|--------|--------|-------|
| BnH | 02H | vvH |

n=MIDI channel No. :0H - FH (0 - 15) 0=ch.1 15=ch.16
 vv=Breath :00H - 7FH (0 - 127)

*When receiving this message, the JD-800 converts it to modulation, aftertouch or volume message according to the settings of Rx breath, one of MIDI functions.

○ Portamento time

| Status | Second | Third |
|--------|--------|-------|
| BnH | 05H | vvH |

n=MIDI channel No. :0H - FH (0 - 15) 0=ch.1 15=ch.16
 vv=Portamento time :00H - 7FH (0 - 127)

*Upon receiving this message, JD-800 changes Portamento time in patch parameter accordingly.

○ Volume

| Status | Second | Third |
|--------|--------|-------|
| BnH | 07H | vvH |

n=MIDI channel No. :0H - FH (0 - 15) 0=ch.1 15=ch.16
 vv=Volume :00H - 7FH (0 - 127)

*When this message is received with Rx volume of MIDI function being set at on, it will chnage:

In MULTI mode - volume of a part (part level); in SINGLE mode - MIDI volume.

In SINGLE mode, volume cannot be adjusted from the panel but can be adjusted from volume pedal by setting ext control to VOL.

*The value of volume in the SINGLE mode are reset to a maximum value (100) in the following cases:

1. On power-up.
2. Mode change from MULTI to SINGLE.

○ Pan

| Status | Second | Third |
|--------|--------|-------|
| BnH | 0AH | vvH |

n=MIDI channel No. :0H - FH (0 - 15) 0=ch.1 15=ch.16
 vv=Pan :00H - 7FH (0 - 127)

*This message is used to localize tone sources in multi mode: "0" represents left end, "127" represent right end with each increment represents one of 61 steps.

In SINGLE mode, this message is ignored.

○ Hold 1

| Status | Second | Third |
|--------|--------|-------|
| BnH | 40H | vvH |

n=MIDI channel No. :0H - FH (0 - 15) 0=ch.1 15=ch.16
 vv=Hold :00H - 7FH (0 - 127) 0=63=OFF 64-127=ON

*JD-800 turns on or off tone hold according to setting of the Hold control in respective tone parameters.

○ Portamento

| Status | Second | Third |
|--------|--------|-------|
| BnH | 41H | vvH |

n=MIDI channel No. :0H - FH (0 - 15) 0=ch.1 15=ch.16
 vv=Portamento :00H - 7FH (0 - 127) 0=63=OFF 64-127=ON

*When this message is recieved, toggles between portamento on/off. Being made functionable only in solo mode, changes the Portamento Switch in respective patch parameters.

○ RPN LSB

| Status | Second | Third |
|--------|--------|-------|
| BnH | 64H | 11H |

n=MIDI channel No. :0H - FH (0 - 15) 0=ch.1 15=ch.16
 11=RPN LSB :00H(0) Pitch Bend Sensitivity
 :01H(1) Fine Tune

*Represents the lower byte of either Pitch Bend Sensitivity or Fine Tune among parameter numbers designated by RPN.

MIDI Implementation

○ RPN MSB

Status Second Third
BnH 65H 00H

n=MIDI channel No. :0H - FH (0 - 15) 0=ch.1 15=ch.16

*Represents the upper byte of either Fine Tune or Pitch Bend Sensitivity among parameter numbers designated by RPN.

*** RPN description ***

Among control changes, there are messages called RPN (registered parameter number) whose function is registered in MIDI standard. Parameters of a MIDI device can be changed using RPN.

To effect PRN, first designate the parameter to be controlled using PRN MSB and RPN LSB, and then specify the value of designated parameter by Data Entry.

The JD-800 can recognize two RPNs: Pitch Bend Sensitivity (RPN#0) and Fine Tune (RPN#1).

RPN #0:Pitch Bend Sensitivity

BnH 64H 00H BnH 65H 00H BnH 06H mmH
(RPN LSB) (RPN MSB) (Data Entry MSB)

n=MIDI channel No. :0H - FH (0 - 15) 0=ch.1 15=ch.16
mm=MSB data :00H - 7FH (0 - 127)

*JD-800 does not recognize the lower byte of Data Entry. It uses the upper byte to change a pitch in steps of semitone. Upper limit of the setting is 0CH (12), and any value exceeding the limit is recognized as 0CH (12).

RPN #1:Fine Tune

BnH 64H 01H BnH 65H 00H BnH 26H 11H BnH 06H mmH
(RPN LSB) (RPN MSB) (Data Entry LSB) (Data Entry MSB)

n=MIDI channel No. :0H - FH (0 - 15) 0=ch.1 15=ch.16
ll=LSB data :00H - 7FH (0 - 127)
mm=MSB data :00H - 7FH (0 - 127)

mm, ll=20H, 00H - 40H, 00H - 60H, 00H (-50cent - 0cent - +50cent)
↑
A=440.0Hz

*With JD-800, this message can be received through receive channel of any parts and recognized as a master tune. That is, if this message is received on a particular part channel, it affects all parts as the master tune.

Setting values are limited to 60H, 00H (96, 00) and 20H, 00H (32, 00) with values exceeding the range being recognized as the upper (or lower) limit.

○ Data entry LSB

Status Second Third
BnH 26H 11H

n=MIDI channel No. :0H - FH (0 - 15) 0=ch.1 15=ch.16
ll=LSB data :0H - 7FH (0 - 127)

*Lower byte of the data for the parameter specified by the RPN. JD-800 changes Fine Tune to this value.

○ Data entry MSB

Status Second Third
BnH 06H mmH

n=MIDI channel No. :0H - FH (0 - 15) 0=ch.1 15=ch.16
mm=MSB data :00H - 7FH (0 - 127)

*Upper byte of the data for the parameter specified by the RPN. JD-800 changes Fine Tune or Pitch Bend Sensitivity to this value.

*** Data Entry description ***

Data Entry sets a value into the parameter specified by RPN (registered parameter number).

JD-800 can recognize two RPNs: pitch bend sensitivity (RPN#0) and fine tune (RPN#1).

RPN #0:Pitch Bend Sensitivity

Data Entry MSB

| BnH 06H mmH | Pitch Bend Sensitivity |
|-------------|------------------------|
| 00H | 0 cent |
| 01H | 100 cent (semitone) |
| | |
| | |
| 0CH | 1200 cent (1 octave) |
| : | : |
| : | : |
| 7FH | 1200 cent (1 octave) |

*JD-800 changes the same value to up and down for Bender range in patch parameters, by an octave in steps of semitone according to the received data.

It ignores the LSB in the Data Entry.

RPN #1:Fine Tune

Data Entry MSB

| Data Entry MSB BnH 06H mmH | Data Entry LSB BnH 26H 11H | Fine Tune |
|-------------------------------|-------------------------------|---------------------|
| 00H | 00H | -50 cent |
| : | : | : |
| 20H | 00H | -50 cent |
| | | |
| 20H | 52H | -49 cent |
| | | |
| | | |
| 40H | 00H | 0 cent (A4=440.0Hz) |
| | | |
| | | |
| 5FH | 2EH | +49 cent |
| | | |
| 60H | 00H | +50 cent |
| : | : | : |
| 7FH | 7FH | +50 cent |

*JD-800 raises or lowers the master tune up to 50 cents in steps of cent according to the received data.

● Program change

Status Second
CnH ppH

n=MIDI channel No. :0H - FH (0 - 15) 0=ch.1 15=ch.16
pp=Program change No. :00H - 7FH (0 - 127)

*When the JD-800 receives this message with Rx program change of MIDI function being on, it shifts to the patch specified by the program number.

JD-800 ignores this message if in patch edit mode (Common or Effect).

| CnH ppH | Patch No. |
|---------|-----------|
| 00H | I-11 |
| 01H | I-12 |
| | |
| 08H | I-21 |
| | |
| 40H | C-11 |
| | |
| 7FH | C-88 |

*When the patch specified by the Patch No. is a card (between C-11 and C-88) and the card is not inserted or wrong one, JD-800 ignores the message and displays error message.

*When the JD-800 receives this message with Rx program change of MIDI function being on and it has Special Part in multi mode, it interprets the message as follows:

| CnH ppH | Setup |
|---------|-------|
| 00H | INT |
| 01H | CARD |

● Channel aftertouch

Status Second
DnH vvH

n=MIDI channel No. :0H - FH (0 - 15) 0=ch.1 15=ch.16
vv=Aftertouch :00H - 7FH (0 - 127)

*When JD-800 receives this message with Rx aftertouch of MIDI function being on, it activates the following effects to the degrees of the received Aftertouch and individual settings: Pitch A-touch Bend Sens in Patch parameter, Pitch A-touch Bend Sw, Pitch A-touch Mod Sens, TVF A-touch Sens and TVA A-touch Sens in Tone parameters.

● Pitch bend change

Status Second Third
EnH 11H mmH

n=MIDI channel No. :0H - FH (0 - 15) 0=ch.1 15=ch.16
mm=MSB data :00H - 7FH (0 - 127)
11=LSB data :00H - 7FH (0 - 127)
mm, 11=00H, 00H - 40H, 00H - 7FH, 7FH (-8192 - 0 - +8191)

*When the JD-800 receives this message with Bender switch of a tone being on, it raises or lowers the pitch to the degrees set by Bender Range Up or Bender Range Down.

■ Channel mode messages

● Reset all controllers

Status Second Third
BnH 79H 00H

n=MIDI channel No. :0H - FH (0 - 15) 0=ch.1 15=ch.16

*This message forces the JD-800 to reset the controller value to the preset value.

| Controller | Preset value |
|-------------------|--------------|
| Pitch bend change | 0 (center) |
| Hold 1 | 0 (off) |
| Modulation | 0 (min) |
| Aftertouch | 0 (min) |
| RPN address | unrecognized |

● Local control

Status Second Third
BnH 7AH vvH

n=MIDI channel No. :0H - FH (0 - 15) 0=ch.1 15=ch.16
vv=Local control:00H, 7FH (0, 127) 0=OFF 127=ON

*This is not a parameter for a particular Part but for all Parts. This message is received commonly on the receiving channel of any part and changeovers local control of MIDI functions; such as note on /off, program change, and enable/disable of remote controllers such as bender and aftertouch.

● All note off

Status Second Third
BnH 7BH 00H

n=MIDI channel No. :0H - FH (0 - 15) 0=ch.1 15=ch.16

*When the JD-800 receives this message, turns off all MIDI-on notes.

● OMNI OFF

Status Second Third
BnH 7CH 00H

n=MIDI channel No. :0H - FH (0 - 15) 0=ch.1 15=ch.16

*With JD-800, this messages acts like All note off.

● OMNI ON

Status Second Third
BnH 7DH 00H

n=MIDI channel No. :0H - FH (0 - 15) 0=ch.1 15=ch.16

* With JD-800, this messages acts like All note off.

MIDI Implementation

● MONO

Status Second Third
BnH 7EH mmH

n=MIDI channel No. :0H - FH (0 - 15) 0=ch.1 15=ch.16
mm=M :ignore

* With JD-800, this messages acts like All note off.

● POLY

Status Second Third
BnH 7FH 00H

n=MIDI channel No. :0H - FH (0 - 15) 0=ch.1 15=ch.16

* With JD-800, this messages acts like All note off.

■ System real time messages

● Active sensing

Status
FEH

*When JD-800 receives Active sensing, it measures time intervals between incoming messages. If the subsequent message will not come within 400 ms after the previous one, JD-800 turns off all MIDI-on notes as if it receives Reset All Controller message, and stops measuring message intervals.

■ System exclusive messages

Status Data bytes
F0H 11H, ddH,, eeH
F7H

F0H :System exclusive
11=ID No. :41H (65)
dd, ..., ee=data :00H-7FH (0-127)
F7H :EOX (End of Exclusive/System common)

*For details, refer to "Roland Exclusive Messages" and Sections 3.

2. TRANSMITTED DATA

*Transmit Channel

JD-800 transmits on one of the channels according to the setting of TX CHANNEL, MIDI function.

| TX CHANNEL | SINGLE Mode | MULTI Mode |
|--------------|---|--|
| 1 - 16 | Transmits on set channel. | |
| Rx ch | Transmits on RX CHANNEL. | Transmits on RX CHANNEL of part sounded by keyboard. |
| Patch (Part) | Transmits on channels set at Patch MIDI parameters. | PART1- 5 : same as in SINGLE mode. PARTS : acts as Rx ch. |
| OFF | No transmission | |

■ Channel voice messages

● Note off

Status Second Third
8nH kkH vvH

n=MIDI channel No. :0H - FH (0 - 15) 0=ch.1 15=ch.16
kk=Note No. :18H - 6CH (24 - 108)
vv=Velocity :01H - 7FH (1 - 127)

● Note on

Status Second Third
9nH kkH vvH

n=MIDI channel No. :0H - FH (0 - 15) 0=ch.1 15=ch.16
kk=Note No. :18H - 6CH (24 - 108)
vv=Velocity :01H - 7FH (1 - 127)

● Control change

○ Modulation

Status Second Third
BnH 01H vvH

n=MIDI channel No. :0H - FH (0 - 15) 0=ch.1 15=ch.16
vv=Modulation :00H - 7FH (0 - 127)

*JD-800 transmits this message when the modulation lever is operated or when the pedal is operated with Ext control set as MOD.

○ Volume

Status Second Third
BnH 07H vvH

n=MIDI channel No. :0H - FH (0 - 15) 0=ch.1 15=ch.16
vv=Volume :00H - 7FH (0 - 127)

*JD-800 transmits this message when the pedal is operated with Ext control set as VOL.

○ Pan

Status Second Third
BnH 0AH vvH

n=MIDI channel No. :0H - FH (0 - 15) 0=ch.1 15=ch.16
vv=Pan :00H - 7FH (0 - 127)

*JD-800 transmits this message when the pedal is operated with Ext control set as PAN.

○ Hold 1

Status Second Third
BnH 40H vvH

n=MIDI channel No. :0H - FH (0 - 15) 0=ch.1 15=ch.16
vv=Hold :00H, 7FH (0, 127) 0=OFF, 127=ON

*JD-800 transmits the message when the hold pedal is operated. If TX CHANNEL is set as PATCH, transmits according to settings of TX hold mode in patch parameter.

● Program change

Status Second
CnH ppH

n=MIDI channel No. :0H - FH (0 - 15) 0=ch.1 15=ch.16
pp=Program change No. :00H - 7FH (0 - 127)

*When patch change is made with Tx program change of MIDI function set as NORMAL, transmits as follows:

| CnH ppH | Patch No. |
|---------|-----------|
| 00H | 1-11 |
| 01H | 1-12 |
| | |
| 08H | 1-21 |
| | |
| 40H | C-11 |
| | |
| 7FH | C-88 |

*With Special part in multi mode: when INT/CARD button is pressed with Tx program change set at NORMAL or PATCH, transmits the following program number.

| CnH ppH | Setup |
|---------|-------|
| 00H | INT |
| 01H | CARD |

*When patch change is made with Tx program change of MIDI function set as PATCH, transmits contents specified by the setting of Tx mode, Tx upper program number and Tx lower program number of Patch MIDI parameters.

● Channel aftertouch

Status Second
DnH vvH

n=MIDI channel No. :0H - FH (0 - 15) 0=ch.1 15=ch.16
vv=Aftertouch :00H - 7FH (0 - 127)

*JD-800 transmits this message when the key is depressed strongly on the keyboard with Tx aftertouch of MIDI function set as on, or when the pedal is operated with Ext control set as AFT.

● Pitch bend change

Status Second Third
EnH llH mmH

n=MIDI channel No. :0H - FH (0 - 15) 0=ch.1 15=ch.16
mm=MSB data :00H - 7FH (0 - 127)
ll=LSB data :00H - 7FH (0 - 127)
mm, ll=00H, 00H - 40H, 00H - 7FH, 7FH (-8192 - 0 - +8191)

*JD-800 transmits this message when the bender lever is operated in right/left direction. The resolution is 9 bits including direction.

■ Channel mode messages

● Reset all controllers

Status Second Third
BnH 79H 00H

n=MIDI channel No. :0H - FH (0 - 15) 0=ch.1 15=ch.16

*Transmits when mode is changed from MULTI to SINGLE or vice versa. The message is transmitted over the channel that has been used.

● OMNI OFF

Status Second Third
BnH 7CH 00H

n=MIDI channel No. :0H - FH (0 - 15) 0=ch.1 15=ch.16

*Transmits when power-up or mode change (from MULTI to SINGLE, or vice versa). The message is transmitted over the channel to be used for transmission.

● POLY

Status Second Third
BnH 7FH 00H

n=MIDI channel No. :0H - FH (0 - 15) 0=ch.1 15=ch.16

*Transmits when power-up or mode change (from MULTI to SINGLE, or vice versa). The message is transmitted over the channel to be used for transmission.

■ System real time messages

● Active sensing

Status
FEH

*Transmits at approx. every 250 ms to external MIDI device to allow the device connected to its MIDI OUT to check for fault in MIDI connection line.

■ System exclusive messages

Status Data bytes
F0H iiH, ddH, ..., eeH
F7H

F0H :System exclusive
ii=ID No. :41H (65)
dd, ..., ee=data :00H-7FH (0-127)
F7H :EOX (End of Exclusive/System common)

For details, refer to "Roland Exclusive Messages" and Sections 3.

3. EXCLUSIVE COMMUNICATIONS

The JD-800 can transmit/receive patch parameters, etc. using exclusive messages.

The model ID code of JD-800 is 3DH. The device ID codes are to be determined by the unit number setting of MIDI function.

■ One-way communication

● Request data RQ1 (11H)

| Byte | Comments |
|------|--------------------------|
| F0H | Exclusive status |
| 41H | Manufactures ID (Roland) |
| Dev | Device ID (UNIT#-1) |
| 3DH | Model ID (JD-800) |
| 11H | Command ID (RQ1) |
| aaH | Address MSB |
| aaH | Address |
| aaH | Address LSB |
| ssH | Size MSB |
| ssH | Size |
| ssH | Size LSB |
| sum | Check sum |
| F7H | EOX (End Of exclusive) |

○ Receiving RQ1

JD-800 receives this message when the data exist in specified address, and moreover the data size is above 1. And then transmits the data specified address and size by DT1 format. However, the address and size of data must be specified in one block (refer to #4-1, #4-2 etc.).

JD-800 never transmits this message.

● Data set DT1 (12H)

| Byte | Comments |
|------|--------------------------|
| F0H | Exclusive status |
| 41H | Manufactures ID (Roland) |
| Dev | Device ID (UNIT#-1) |
| 3DH | Model ID (JD-800) |
| 12H | Command ID (DT1) |
| aaH | Address MSB |
| aaH | Address |
| aaH | Address LSB |
| ddH | Data |
| : | : |
| ddH | Data |
| sum | Check sum |
| F7H | EOX (End Of exclusive) |

○ Receiving DT1

JD-800 receives this message when the data exist in specified address. And then stores the received data into the specified address area. However, if make intervals at less 25msec during DT1 messages, JD-800 cannot manage the received data normally.

○ Transmission DT1

JD-800 transmits this message as follows; and when the data size is over 256 bytes, it is sent out in separate segments.

1) Patch dump

Transmits the following data when patch dump is executed.

- In SINGLE mode All the data of Patch Temporary Area (*4-1-1).
- In MULTI mode All the data of Patch Temporary Area (*4-1-2) or Special Setup Temporary Area (*4-2) at current part.

2) Bulk dump

Transmits the following data when bulk dump is executed.

- Selected "All" block The data of System Area (*4-3) Special Setup Memory Area (*4-2), Patch Memory Area (*4-5)
- Selected "Patch" block The data of Patch Memory Area (*4-5).
- Selected "Setup" block The data of Special Setup Memory Area (*4-2).

3) Editing tone parameters

*When the slider or switch of tone parameters is moved with Tx edit data of MIDI function set as ON, JD-800 transmits the data according to tone parameter of Patch Temporary Area (*4-1-1 or *4-1-2). When the slider or switch of tone parameter is moved in the Key SetupEdit, JD-800 transmits the data corresponding to the tone parameters of Special Setup Temporary Area (*4-2).

4. PARAMETER ADDRESS MAP (Model ID=3DH)

Address is configured in 7 bits, and expressed in hexadecimal.

| Address | MSB | LSB |
|-----------|-----------|---------------------|
| Binary | 0aaa aaaa | 0bbb bbbb 0ccc cccc |
| 7-bit hex | AA | BB CC |

■ Parameter Address Block

Description is made on each block (*4-1, *4-2, etc.).

| Start | address | Contents and remarks | Command |
|----------|---------|------------------------------|-------------|
| 00 00 00 | | Patch Temporary Area | *4-1 o o |
| 01 00 00 | | Special Setup Temporary Area | *4-2 o o |
| 02 00 00 | | System Area | *4-3 o o |
| 03 00 00 | | Part Area | *4-4 o o |
| 04 00 00 | | Special Setup Memory Area | *4-2 o o |
| 05 00 00 | | Patch Memory Area | *4-5 o o |
| 07 00 00 | | Display Area | *4-6 x o |

o:available x:unavailable

Actual address value is the sum of a start address listed in the parameter address block and an offset address.

In the application examples of RQ1 and DT1 below, Device ID uses 10H (UNIT# = 17).

*4-1 Patch Temporary Area

The patch parameters for the part used for sound generation are set in this area.

| Offset | address | Contents and remarks | |
|------------|-------------------|-------------------------------|-------------|
| 00 00 00 | | (Single)Patch Temporary | *4-1-1 |
| 00 10 00 | | (Multi)Part 1 Patch Temporary | *4-1-2 |
| 00 12 52 | | (Multi)Part 2 Patch Temporary | : |
| 00 15 24 | | (Multi)Part 3 Patch Temporary | : |
| 00 17 76 | | (Multi)Part 4 Patch Temporary | : |
| 00 1A 48 | | (Multi)Part 5 Patch Temporary | : |
| ----- | | | |
| Total Size | (Single) 00 03 00 | (384bytes) | |
| | (Multi)Part 1 - 5 | 00 0D 1A | (1690bytes) |

*4-1-1 Single Patch Temporary

Disabled during MULTI mode.

| Offset | address | Contents and remarks | |
|------------|----------|----------------------|----------|
| 00 00 00 | | Patch Common | *4-5-1-1 |
| 00 00 32 | | Patch Effect | *4-5-1-2 |
| 00 00 60 | | Patch Tone-A | *4-5-1-3 |
| 00 01 28 | | Patch Tone-B | : |
| 00 01 70 | | Patch Tone-C | : |
| 00 02 38 | | Patch Tone-D | : |
| ----- | | | |
| Total Size | 00 03 00 | (384bytes) | |

*4-1-2 Multi Patch Temporary

Disabled during SINGLE mode.

| Offset | address | Contents and remarks | |
|------------|----------|----------------------|----------|
| 00 00 00 | | Patch Common | *4-5-1-1 |
| 00 00 32 | | Patch Tone-A | *4-5-1-3 |
| 00 00 7A | | Patch Tone-B | : |
| 00 01 42 | | Patch Tone-C | : |
| 00 02 0A | | Patch Tone-D | : |
| ----- | | | |
| Total Size | 00 02 52 | (338bytes) | |

*4-2 Special Setup Memory Area / Temporary Area

This area holds parameters for each key of special part used for sound generation. This Temporary Area is disabled during SINGLE mode.

| Offset | address | Contents and remarks | |
|------------|----------|---------------------------------|--------|
| 00 00 00 | | Special Setup Common / EQ | *4-2-1 |
| 00 00 0A | | Special Setup Key C2 (Note# 36) | *4-2-2 |
| 00 00 62 | | Special Setup Key C#2(Note# 37) | : |
| 00 01 3A | | Special Setup Key D2 (Note# 38) | : |
| 00 02 12 | | Special Setup Key D#2(Note# 39) | : |
| 00 02 6A | | Special Setup Key E2 (Note# 40) | : |
| 00 03 42 | | Special Setup Key F2 (Note# 41) | : |
| 00 04 1A | | Special Setup Key F#2(Note# 42) | : |
| 00 04 72 | | Special Setup Key G2 (Note# 43) | : |
| 00 05 4A | | Special Setup Key G#2(Note# 44) | : |
| 00 06 22 | | Special Setup Key A2 (Note# 45) | : |
| 00 06 7A | | Special Setup Key A#2(Note# 46) | : |
| 00 07 52 | | Special Setup Key B2 (Note# 47) | : |
| 00 08 2A | | Special Setup Key C3 (Note# 48) | : |
| 00 09 02 | | Special Setup Key C#3(Note# 49) | : |
| 00 09 5A | | Special Setup Key D3 (Note# 50) | : |
| 00 0A 32 | | Special Setup Key D#3(Note# 51) | : |
| 00 0B 0A | | Special Setup Key E3 (Note# 52) | : |
| 00 0B 62 | | Special Setup Key F3 (Note# 53) | : |
| 00 0C 3A | | Special Setup Key F#3(Note# 54) | : |
| 00 0D 12 | | Special Setup Key G3 (Note# 55) | : |
| 00 0D 6A | | Special Setup Key G#3(Note# 56) | : |
| 00 0E 42 | | Special Setup Key A3 (Note# 57) | : |
| 00 0F 1A | | Special Setup Key A#3(Note# 58) | : |
| 00 0F 72 | | Special Setup Key B3 (Note# 59) | : |
| 00 10 4A | | Special Setup Key C4 (Note# 60) | : |
| 00 11 22 | | Special Setup Key C#4(Note# 61) | : |
| 00 11 7A | | Special Setup Key D4 (Note# 62) | : |
| 00 12 52 | | Special Setup Key D#4(Note# 63) | : |
| 00 13 2A | | Special Setup Key E4 (Note# 64) | : |
| 00 14 02 | | Special Setup Key F4 (Note# 65) | : |
| 00 14 5A | | Special Setup Key F#4(Note# 66) | : |
| 00 15 32 | | Special Setup Key G4 (Note# 67) | : |
| 00 16 0A | | Special Setup Key G#4(Note# 68) | : |
| 00 16 62 | | Special Setup Key A4 (Note# 69) | : |
| 00 17 3A | | Special Setup Key A#4(Note# 70) | : |
| 00 18 12 | | Special Setup Key B4 (Note# 71) | : |
| 00 18 6A | | Special Setup Key C5 (Note# 72) | : |
| 00 19 42 | | Special Setup Key C#5(Note# 73) | : |
| 00 1A 1A | | Special Setup Key D5 (Note# 74) | : |
| 00 1A 72 | | Special Setup Key D#5(Note# 75) | : |
| 00 1B 4A | | Special Setup Key E5 (Note# 76) | : |
| 00 1C 22 | | Special Setup Key F5 (Note# 77) | : |
| 00 1C 7A | | Special Setup Key F#5(Note# 78) | : |
| 00 1D 52 | | Special Setup Key G5 (Note# 79) | : |
| 00 1E 2A | | Special Setup Key G#5(Note# 80) | : |
| 00 1F 02 | | Special Setup Key A5 (Note# 81) | : |
| 00 1F 5A | | Special Setup Key A#5(Note# 82) | : |
| 00 20 32 | | Special Setup Key B5 (Note# 83) | : |
| 00 21 0A | | Special Setup Key C6 (Note# 84) | : |
| 00 21 62 | | Special Setup Key C#6(Note# 85) | : |
| 00 22 3A | | Special Setup Key D6 (Note# 86) | : |
| 00 23 12 | | Special Setup Key D#6(Note# 87) | : |
| 00 23 6A | | Special Setup Key E6 (Note# 88) | : |
| 00 24 42 | | Special Setup Key F6 (Note# 89) | : |
| 00 25 1A | | Special Setup Key F#6(Note# 90) | : |
| 00 25 72 | | Special Setup Key G6 (Note# 91) | : |
| 00 26 4A | | Special Setup Key G#6(Note# 92) | : |
| 00 27 22 | | Special Setup Key A6 (Note# 93) | : |
| 00 27 7A | | Special Setup Key A#6(Note# 94) | : |
| 00 28 52 | | Special Setup Key B6 (Note# 95) | : |
| 00 29 2A | | Special Setup Key C6 (Note# 96) | : |
| ----- | | | |
| Total Size | 00 2A 02 | (5378bytes) | |

MIDI Implementation

*4-2-1 Special Setup Common / EQ

| Offset | address | Data | Contents and remarks |
|--|---------|-------------------|----------------------------|
| < EQ > | | | |
| 00 00 00 | 00 - 01 | Low freq | 200, 400Hz |
| 00 00 01 | 00 - 1E | Low gain | -15.0 - +15.0dB (1dB step) |
| 00 00 02 | 00 - 10 | Mid freq | 200 - 8kHz [*1] |
| 00 00 03 | 00 - 04 | Mid Q | 0.5, 1.0, 2.0, 4.0, 9.0 |
| 00 00 04 | 00 - 1E | Mid gain | -15.0 - +15.0dB (1dB step) |
| 00 00 05 | 00 - 01 | High freq | 4k, 8kHz |
| 00 00 06 | 00 - 1E | High gain | -15.0 - +15.0dB (1dB step) |
| < COMMON > | | | |
| 00 00 07 | 00 - 30 | Bender range down | 0 - 48 semi |
| 00 00 08 | 00 - 0C | Bender range up | 0 - 12 semi |
| 00 00 09 | 00 - 1A | A-touch bend sens | -36, -24, -12 - +12 semi |
| Total Size 00 00 0A (10bytes) | | | |
| [*1]:200, 250, 315, 400, 500, 630, 800, 1k, 1.25k, 1.6k, 2k, 2.5k, 3.15k, 4k, 5k, 6.3k, 8kHz | | | |

*4-2-2 Special Setup Key

| Offset | address | Contents and remarks |
|-------------------------------|-----------|----------------------|
| 00 00 00 | Setup Key | *4-2-2-1 |
| 00 00 10 | Key Tone | *4-5-1-3 |
| Total Size 00 00 58 (88bytes) | | |

*4-2-2-1 Setup Key

| Offset | address | Data | Contents and remarks |
|-------------------------------|---------|--------------|----------------------------|
| 00 00 00 | 20 - 7F | Name 1 | (ASCII) |
| : | : | : | : |
| 00 00 09 | 20 - 7F | Name 10 | (ASCII) |
| 00 00 0A | 00 - 08 | Mute group | OFF, A - H |
| 00 00 0B | 00 - 01 | ENV mode | SUSTAIN, NO SUSTAIN |
| 00 00 0C | 00 - 3C | Pan | L30 - 00 - 30R |
| 00 00 0D | 00 - 03 | Effect mode | DRY, REV, CHO+REV, DLY+REV |
| 00 00 0E | 00 - 64 | Effect level | 0 - 100 |
| 00 00 0F | 00 - 00 | <Dummy> | |
| Total Size 00 00 10 (16bytes) | | | |

/Application example of RQ1/

To derive all names within the setup memory key data of note #60, transmit the following data to the JD-800.

```
F0 41 10 3D 11 04 10 4A 00 00 0A 18 F7
```

/Application example of DT1/

To set the effect mode within the setup temporary key data of note #50 as REV, transmit the following data to the JD-800.

```
F0 41 10 3D 12 04 09 67 01 0B F7
```

*4-3 System Area

This area holds parameters for system used for sound generation.

| Offset | address | Data | Contents and remarks |
|--|---------|-----------------|--|
| 00 00 00 | 00 - 64 | Master tune | 427.5 - 452.9Hz (+/-50cent, 1cent step) |
| < Mix out filter > | | | |
| 00 00 01 | 00 - 0A | Treble | -5 - +5 |
| 00 00 02 | 00 - 0A | Mid | -5 - +5 |
| 00 00 03 | 00 - 0A | Bass | -5 - +5 |
| < Effect B master switch > | | | |
| 00 00 04 | 00 - 01 | Chorus switch | OFF, ON |
| 00 00 05 | 00 - 01 | Delay switch | OFF, ON |
| 00 00 06 | 00 - 01 | Reverb switch | OFF, ON |
| < Delay > | | | |
| 00 00 07 | 00 - 7D | Center tap | 0.1 - 600ms [*1] |
| 00 00 08 | 00 - 64 | Center level | 0 - 100 |
| 00 00 09 | 00 - 7D | Left tap | 0.1 - 600ms [*1] |
| 00 00 0A | 00 - 64 | Left level | 0 - 100 |
| 00 00 0B | 00 - 7D | Right tap | 0.1 - 600ms [*1] |
| 00 00 0C | 00 - 64 | Right level | 0 - 100 |
| 00 00 0D | 00 - 62 | Feedback | -98 - 0 - +98% (2% step) |
| < Chorus > | | | |
| 00 00 0E | 00 - 63 | Rate | 0.1 - 10Hz (0.1Hz step) |
| 00 00 0F | 00 - 64 | Depth | 0 - 100 |
| 00 00 10 | 00 - 63 | Delay time | 0.1 - 50ms [*2] |
| 00 00 11 | 00 - 62 | Feedback | -98 - 0 - +98% (2% step) |
| 00 00 12 | 00 - 64 | Level | 0 - 100 |
| < Reverb > | | | |
| 00 00 13 | 00 - 09 | Type | [*3] |
| 00 00 14 | 00 - 79 | Pre delay | 0 - 120ms (1ms step) |
| 00 00 15 | 00 - 64 | Early ref level | 0 - 100 |
| 00 00 16 | 00 - 10 | HF damp | 500Hz - BYPASS [*4] |
| 00 00 17 | 00 - 64 | Time | 0.1 - 20s [*5] |
| 00 00 18 | 00 - 64 | Level | 0 - 100 |
| Total Size 00 00 19 (25bytes) | | | |
| [*1]:0.1-5ms(0.1ms step), 5.5-10ms(0.5ms step), 11-40ms(1ms step), 50-200ms(10ms step), 220-600ms(20ms step) | | | |
| [*2]:0.1-5ms(0.1ms step), 5.5-10ms(0.5ms step), 11-50ms(1ms step) | | | |
| [*3]:ROOM1, ROOM2, HALL1, HALL2, HALL3, HALL4, GATE, REVERSE, FLYING1, FLYING2 | | | |
| [*4]:500, 630, 800, 1k, 1.25k, 1.6k, 2k, 2.5k, 3.15k, 4k, 5k, 6.3k, 8k, 10k, 12.5k, 16kHz, BYPASS | | | |
| [*5]:0.1-10s(0.1s step), 10-20s(0.5s step); (ROOM1/2, HALL1/2/3/4) 5-500ms(5ms step); (GATE, REVERSE, FLYING1/2) | | | |

/Application example of RQ1/

To derive all the system data during MULTI mode, transmit the following data to the JD-800.

```
F0 41 10 3D 11 02 00 00 00 19 65 F7
```

/Application example of DT1/

To set the chorus level of effect to 100 during MULTI mode, transmit the following data to the JD-800.

```
F0 41 10 3D 12 02 00 12 64 08 F7
```

=====

=====

*4-4 Part Area

This area contains parameters for part used for sound generation. Disabled during SINGLE mode.

| Offset | address | Contents and remarks |
|-------------------------------|--------------|----------------------|
| 00 00 00 | Part 1 | *4-4-1 |
| 00 00 06 | Part 2 | : |
| 00 00 0C | Part 3 | : |
| 00 00 12 | Part 4 | : |
| 00 00 18 | Part 5 | : |
| 00 00 1E | Special Part | *4-4-2 |
| Total Size 00 00 22 (34bytes) | | |

*4-4-1 Part 1 - Part 5

Disabled during SINGLE mode.

| Offset | address | Data | Contents and remarks |
|------------------------------|---------|---------------|----------------------------|
| 00 00 00 | 00 - 64 | Level | 0 - 100 |
| 00 00 01 | 00 - 3C | Pan | L30 - 00 - 30R |
| 00 00 02 | 00 - 10 | MIDI Rx Ch. | 1 - 16, OFF |
| 00 00 03 | 00 - 01 | Output assign | MIX, DIR |
| 00 00 04 | 00 - 03 | Effect mode | DRY, REV, CHO+REV, DLY+REV |
| 00 00 05 | 00 - 64 | Effect level | 0 - 100 |
| Total Size 00 00 06 (6bytes) | | | |

/Application example of RQ1/

To derive all the data within part 3, transmit the following data to the JD-800.

F0 41 10 3D 11 03 00 0C 00 00 06 6B F7

/Application example of DT1/

To set the effect level of part 5 to 50, transmit the following data to the JD-800.

F0 41 10 3D 12 03 00 1D 32 2E F7

*4-4-2 Special Part

Disabled during SINGLE mode.

| Offset | address | Data | Contents and remarks |
|------------------------------|---------|---------------|----------------------|
| 00 00 00 | 00 - 64 | Level | 0 - 100 |
| 00 00 01 | 00 - 10 | MIDI Rx Ch. | 1 - 16, OFF |
| 00 00 02 | 00 - 01 | Output assign | MIX, DIR |
| 00 00 03 | 00 - 00 | <dummy> | |
| Total Size 00 00 04 (4bytes) | | | |

/Application example of RQ1/

To derive all the data within special part, transmit the following data to the JD-800.

F0 41 10 3D 11 03 00 1E 00 00 04 5B F7

/Application example of DT1/

To set the level to 80, transmit the following data to the JD-800.

F0 41 10 3D 12 03 00 1E 50 0F F7

=====

*4-5 Patch Memory Area

| Offset | address | Contents and remarks | Offset | address | Contents and remarks |
|----------------------------------|------------|----------------------|----------|------------|----------------------|
| 00 00 00 | Patch 1-11 | *4-5-1 | 00 60 00 | Patch 1-51 | *4-5-1 |
| 00 03 00 | Patch 1-12 | : | 00 63 00 | Patch 1-52 | : |
| 00 06 00 | Patch 1-13 | : | 00 66 00 | Patch 1-53 | : |
| 00 09 00 | Patch 1-14 | : | 00 69 00 | Patch 1-54 | : |
| 00 0C 00 | Patch 1-15 | : | 00 6C 00 | Patch 1-55 | : |
| 00 0F 00 | Patch 1-16 | : | 00 6F 00 | Patch 1-56 | : |
| 00 12 00 | Patch 1-17 | : | 00 72 00 | Patch 1-57 | : |
| 00 15 00 | Patch 1-18 | : | 00 75 00 | Patch 1-58 | : |
| 00 18 00 | Patch 1-21 | : | 00 78 00 | Patch 1-61 | : |
| 00 1B 00 | Patch 1-22 | : | 00 7B 00 | Patch 1-62 | : |
| 00 1E 00 | Patch 1-23 | : | 00 7E 00 | Patch 1-63 | : |
| 00 21 00 | Patch 1-24 | : | 01 01 00 | Patch 1-64 | : |
| 00 24 00 | Patch 1-25 | : | 01 04 00 | Patch 1-65 | : |
| 00 27 00 | Patch 1-26 | : | 01 07 00 | Patch 1-66 | : |
| 00 2A 00 | Patch 1-27 | : | 01 0A 00 | Patch 1-67 | : |
| 00 2D 00 | Patch 1-28 | : | 01 0D 00 | Patch 1-68 | : |
| 00 30 00 | Patch 1-31 | : | 01 10 00 | Patch 1-71 | : |
| 00 33 00 | Patch 1-32 | : | 01 13 00 | Patch 1-72 | : |
| 00 36 00 | Patch 1-33 | : | 01 16 00 | Patch 1-73 | : |
| 00 39 00 | Patch 1-34 | : | 01 19 00 | Patch 1-74 | : |
| 00 3C 00 | Patch 1-35 | : | 01 1C 00 | Patch 1-75 | : |
| 00 3F 00 | Patch 1-36 | : | 01 1F 00 | Patch 1-76 | : |
| 00 42 00 | Patch 1-37 | : | 01 22 00 | Patch 1-77 | : |
| 00 45 00 | Patch 1-38 | : | 01 25 00 | Patch 1-78 | : |
| 00 48 00 | Patch 1-41 | : | 01 28 00 | Patch 1-81 | : |
| 00 4B 00 | Patch 1-42 | : | 01 2B 00 | Patch 1-82 | : |
| 00 4E 00 | Patch 1-43 | : | 01 2E 00 | Patch 1-83 | : |
| 00 51 00 | Patch 1-44 | : | 01 31 00 | Patch 1-84 | : |
| 00 54 00 | Patch 1-45 | : | 01 34 00 | Patch 1-85 | : |
| 00 57 00 | Patch 1-46 | : | 01 37 00 | Patch 1-86 | : |
| 00 5A 00 | Patch 1-47 | : | 01 3A 00 | Patch 1-87 | : |
| 00 5D 00 | Patch 1-48 | : | 01 3D 00 | Patch 1-88 | : |
| Total Size 01 40 00 (24576bytes) | | | | | |

*4-5-1 Patch Memory

| Offset | address | Contents and remarks |
|--------------------------------|--------------|----------------------|
| 00 00 00 | Patch Common | *4-5-1-1 |
| 00 00 32 | Patch Effect | *4-5-1-2 |
| 00 00 60 | Patch Tone-A | *4-5-1-3 |
| 00 01 28 | Patch Tone-B | : |
| 00 01 70 | Patch Tone-C | : |
| 00 02 38 | Patch Tone-D | : |
| Total Size 00 03 00 (384bytes) | | |

*4-5-1-1 Patch Memory Common / Patch Temporary Common

| Offset | address | Data | Contents and remarks |
|----------|---------|----------------------|----------------------|
| 00 00 00 | 20 - 7F | Patch name1 | (ASCII) |
| : | : | : | : |
| 00 00 0F | 20 - 7F | Patch name16 | (ASCII) |
| 00 00 10 | 00 - 64 | Patch level | 0 - 100 |
| 00 00 11 | 00 - 7F | Key range L (Tone A) | C-1 - G9 |
| 00 00 12 | 00 - 7F | Key range H (Tone A) | C-1 - G9 |
| 00 00 13 | 00 - 7F | Key range L (Tone B) | C-1 - G9 |
| 00 00 14 | 00 - 7F | Key range H (Tone B) | C-1 - G9 |
| 00 00 15 | 00 - 7F | Key range L (Tone C) | C-1 - G9 |
| 00 00 16 | 00 - 7F | Key range H (Tone C) | C-1 - G9 |

MIDI Implementation

```

| 00 00 17 | 00 - 7F | Key range L (Tone D)      C-1 - G9|
| 00 00 18 | 00 - 7F | Key range H (Tone D)      C-1 - G9|
| 00 00 19 | 00 - 30 | Bender range down         0 - 48|
| 00 00 1A | 00 - 0C | Bender range up           0 - 12|
| 00 00 1B | 00 - 1A | A-touch bend      -36, -24, -12 - +12(semi)|
| 00 00 1C | 00 - 01 | Solo SW                   OFF, ON|
| 00 00 1D | 00 - 01 | Solo Legato               OFF, ON|
| 00 00 1E | 00 - 01 | Portamento SW            OFF, ON|
| 00 00 1F | 00 - 01 | Portamento mode          NORMAL, LEGATO|
| 00 00 20 | 00 - 64 | Portamento time          0 - 100|
| 00 00 21 | 00 - 0F | Layer tone                 none - ABCD [*1]|
| 00 00 22 | 00 - 0F | Active tone                none - ABCD [*1]|

```

< EQ >

```

| 00 00 23 | 00 - 01 | Low freq           200, 400Hz|
| 00 00 24 | 00 - 1E | Low gain      -15.0 - +15.0dB (1dB step)|
| 00 00 25 | 00 - 10 | Mid freq           200 - 8kHz [*2]|
| 00 00 26 | 00 - 04 | Mid Q              0.5, 1.0, 2.0, 4.0, 9.0|
| 00 00 27 | 00 - 1E | Mid gain      -15.0 - +15.0dB (1dB step)|
| 00 00 28 | 00 - 01 | High freq          4k, 8kHz|
| 00 00 29 | 00 - 1E | High gain      -15.0 - +15.0dB (1dB step)|

```

< MIDI TX >

```

| 00 00 2A | 00 - 02 | Key mode           WHOLE, SPLIT, DUAL|
| 00 00 2B | 00 - 55 | Split point        C1 - C#8|
| 00 00 2C | 00 - 0F | Lower channel      1 - 16|
| 00 00 2D | 00 - 0F | Upper channel      1 - 16|
| 00 00 2E | 00 - 7F | Lower program change 1 - 128|
| 00 00 2F | 00 - 7F | Upper program change 1 - 128|
| 00 00 30 | 00 - 02 | Hold mode          UPPER, LOWER, BOTH|
| 00 00 31 | 00 - 00 | <dummy>

```

Total Size| 00 00 32 (50bytes)

[*1]:none, A, B, AB, C, AC, BC, ABC, D, AD, BD, ABD, CD, ACD, BCD, ABCD

[*2]:200, 250, 315, 400, 500, 630, 800, 1k, 1.25k, 1.6k, 2k, 2.5k, 3.15k, 4k, 5k, 6.3k, 8kHz

/Application example of RQ1/

To derive all the equalizer data within patch 1-51, transmit the following data to the JD-800.

```
FO 41 10 3D 11 05 60 23 00 00 07 71 F7
```

/Application example of DTL/

To set the patch level of patch 1-21 to 100, transmit the following data to the JD-800.

```
FO 41 10 3D 12 05 18 10 64 6F F7
```

*4-5-1-2 Patch Memory Effect / Patch Temporary Effect

Not available for patch temporary during MULTI mode.

```

+-----+
| Offset |      |
| address | Data | Contents and remarks |
+-----+

```

< Effect Chain >

```

| 00 00 00 | 00 - 17 | Group-A sequence      [*1]|
| 00 00 01 | 00 - 05 | Group-B sequence      [*2]|
| 00 00 02 | 00 - 01 | Group-A block-1 sw    OFF, ON|
| 00 00 03 | 00 - 01 | Group-A block-2 sw    OFF, ON|
| 00 00 04 | 00 - 01 | Group-A block-3 sw    OFF, ON|
| 00 00 05 | 00 - 01 | Group-A block-4 sw    OFF, ON|
| 00 00 06 | 00 - 01 | Group-B block-1 sw    OFF, ON|
| 00 00 07 | 00 - 01 | Group-B block-2 sw    OFF, ON|
| 00 00 08 | 00 - 01 | Group-B block-3 sw    OFF, ON|
| 00 00 09 | 00 - 64 | Group-B effect balance 100:0 - 0:100|

```

```

|< Distortion >
+-----+
| 00 00 0A | 00 - 06 | Type                  [*3]|
| 00 00 0B | 00 - 64 | Drive                 0 - 100|
| 00 00 0C | 00 - 64 | Level                 0 - 100|
+-----+

```

< Phaser >

```

| 00 00 0D | 00 - 63 | Manual                50 - 15KHz [*4]|
| 00 00 0E | 00 - 63 | Rate                  0.1 - 10Hz(0.1Hz step)|
| 00 00 0F | 00 - 64 | Depth                 0 - 100|
| 00 00 10 | 00 - 64 | Resonance             0 - 100|
| 00 00 11 | 00 - 64 | Mix                   0 - 100|
+-----+

```

< Spectrum >

```

| 00 00 12 | 00 - 1E | Band 1                -15 - +15|
| 00 00 13 | 00 - 1E | Band 2                -15 - +15|
| 00 00 14 | 00 - 1E | Band 3                -15 - +15|
| 00 00 15 | 00 - 1E | Band 4                -15 - +15|
| 00 00 16 | 00 - 1E | Band 5                -15 - +15|
| 00 00 17 | 00 - 1E | Band 6                -15 - +15|
| 00 00 18 | 00 - 04 | Band width            1 - 5|
+-----+

```

< Enhancer >

```

| 00 00 19 | 00 - 64 | Sens                  0 - 100|
| 00 00 1A | 00 - 64 | Mix                   0 - 100|
+-----+

```

< Delay >

```

| 00 00 1B | 00 - 7D | Center tap            0.1 - 600ms [*5]|
| 00 00 1C | 00 - 64 | Center level          0 - 100|
| 00 00 1D | 00 - 7D | Left tap              0.1 - 600ms [*5]|
| 00 00 1E | 00 - 64 | Left level            0 - 100|
| 00 00 1F | 00 - 7D | Right tap             0.1 - 600ms [*5]|
| 00 00 20 | 00 - 64 | Right level           0 - 100|
| 00 00 21 | 00 - 62 | Feedback              -98 - 0 - +98%(2% step)|
+-----+

```

< Chorus >

```

| 00 00 22 | 00 - 63 | Rate                  0.1 - 10Hz(0.1Hz step)|
| 00 00 23 | 00 - 64 | Depth                 0 - 100|
| 00 00 24 | 00 - 63 | Delay time            0.1 - 50ms [*6]|
| 00 00 25 | 00 - 62 | Feedback              -98 - 0 - +98%(2% step)|
| 00 00 26 | 00 - 64 | Level                 0 - 100|
+-----+

```

< Reverb >

```

| 00 00 27 | 00 -    | Type                  [*7]|
| 00 00 28 | 00 - 79 | Pre delay            0 - 120ms(1ms step)|
| 00 00 29 | 00 - 64 | Early ref level      0 - 100|
| 00 00 2A | 00 - 10 | HF dump              500Hz - BYPASS [*8]|
| 00 00 2B | 00 - 64 | Time                 0.1 - 20s [*9]|
| 00 00 2C | 00 - 64 | Level                 0 - 100|
| 00 00 2D | 00 - 00 | <dummy>
+-----+

```

Total Size| 00 00 2E (46bytes)

[*1]:DS-PH-SP-EN, DS-PH-EN-SP, DS-SP-EN-PH, DS-SP-PH-EN, DS-EN-PH-SP, DS-EN-SP-PH, PH-DS-EN-SP, PH-DS-EN-SP,

PH-SP-EN-DS, PH-SP-DS-EN, PH-EN-DS-SP, PH-EN-SP-DS, SP-PH-DS-EN, SP-PH-EN-DS, SP-DS-EN-PH, SP-DS-PH-EN, SP-EN-PH-DS, SP-EN-DS-PH, EN-PH-SP-DS, EN-PH-DS-SP,

EN-SP-DS-PH, EN-SP-PH-DS, EN-DS-PH-SP, EN-DS-SP-PH

[*2]:CHO-DLY-REV, CHO-REV-DLY, DLY-CHO-REV, DLY-REV-CHO, REV-CHO-DLY, REV-DLY-CHO

[*3]:MELLOW DRIVE, OVERDRIVE, CRY DRIVE,

MELLOW DIST, LIGHT DIST, FAT DIST, FUZZ DIST

[*4]:50-300Hz(10Hz step), 320Hz, 350-1010Hz(30Hz step), 1.1k-8.1kHz(0.2kHz step), 8.5k-15kHz(0.5kHz step)

```
[*5]:0.1-5ms(0.1ms step), 5.5-10ms(0.5ms step), 11-40ms(1ms step),
50-200ms(10ms step), 220-600ms(20ms step)
[*6]:0.1-5ms(0.1ms step), 5.5-10ms(0.5ms step), 11-50ms(1ms step)
[*7]:ROOM1, ROOM2, HALL1, HALL2, HALL3, HALL4,
GATE, REVERSE, FLYING1, FLYING2
[*8]:500, 630, 800, 1k, 1.25k, 1.6k, 2k, 2.5k, 3.15k, 4k,
5k, 6.3k, 8k, 10k, 12.5k, 16kHz, BYPASS
[*9]:0.1-10s(0.1s step), 10-20s(0.5s step);(ROOM1/2,HALL1/2/3/4)
5-500ms(5ms step);(GATE, REVERSE, FLYING1/2)
```

/Application example of RQ1/
 To derive all the effect data within patch 1-41, transmit the following data to the JD-800.
 FO 41 10 3D 11 05 48 32 00 00 2E 53 F7

/Application example of DT1/
 To set the phaser mix of patch 1-71 to 100, transmit the following data to the JD-800.
 FO 41 10 3D 12 06 10 43 64 43 F7

*4-5-1-3 Patch Memory Tone / Patch Temporary Tone / Setup Key Tone

| Offset | address | Data | Contents and remarks |
|---------------|---------|------------------|-------------------------|
| ----- | | | |
| < COMMON > | | | |
| ----- | | | |
| 00 00 00 | 00 - 03 | Velocity curve | 1, 2, 3, 4 |
| 00 00 01 | 00 - 01 | Hold control | OFF, ON |
| ----- | | | |
| < LFO 1 > | | | |
| ----- | | | |
| 00 00 02 | 00 - 64 | Rate | 0 - 100 |
| 00 00 03 | 00 - 65 | Delay | 0 - 100, REL |
| 00 00 04 | 00 - 64 | Fade | -50 - +50 |
| 00 00 05 | 00 - 04 | Waveform | TRI, SAW, SQU, S/H, RND |
| 00 00 06 | 00 - 02 | Offset | +, 0, - |
| 00 00 07 | 00 - 01 | Key trigger | OFF, ON |
| ----- | | | |
| < LFO 2 > | | | |
| ----- | | | |
| 00 00 08 | 00 - 64 | Rate | 0 - 100 |
| 00 00 09 | 00 - 65 | Delay | 0 - 100, REL |
| 00 00 0A | 00 - 64 | Fade | -50 - +50 |
| 00 00 0B | 00 - 04 | Waveform | TRI, SAW, SQU, S/H, RND |
| 00 00 0C | 00 - 02 | Offset | +, 0, - |
| 00 00 0D | 00 - 01 | Key trigger | OFF, ON |
| ----- | | | |
| < WG > | | | |
| ----- | | | |
| 00 00 0E | 00 - 01 | Wave source | INT, CARD |
| 00 00 0F | 00 - 01 | Waveform MSB | |
| 00 00 10 | 00 - 7F | Waveform LSB | 0 - 255 [*1] |
| 00 00 11 | 00 - 60 | Pitch coarse | -48 - +48 |
| 00 00 12 | 00 - 64 | Pitch fine | -50 - +50 |
| 00 00 13 | 00 - 64 | Pitch random | 0 - 100 |
| 00 00 14 | 00 - 10 | Key follow | -100 - 0 - +200(%) [*2] |
| 00 00 15 | 00 - 01 | Bender | OFF, ON |
| 00 00 16 | 00 - 01 | A-touch bend | OFF, ON |
| 00 00 17 | 00 - 64 | LFO1 sens | -50 - +50 |
| 00 00 18 | 00 - 64 | LFO2 sens | -50 - +50 |
| 00 00 19 | 00 - 64 | Lever sens | LFO2(50) - 0 - LFO1(50) |
| 00 00 1A | 00 - 64 | A-touch mod sens | LFO2(50) - 0 - LFO1(50) |
| ----- | | | |
| < PITCH ENV > | | | |
| ----- | | | |
| 00 00 1B | 00 - 64 | Velo | -50 - +50 |
| 00 00 1C | 00 - 64 | Time velo | -50 - +50 |
| 00 00 1D | 00 - 14 | Time KF | -10 - +10 |
| 00 00 1E | 00 - 64 | Level 0 | -50 - +50 |
| 00 00 1F | 00 - 64 | Time 1 | 0 - 100 |

| | | | |
|--------------------------------|---------|----------------|-------------------------|
| 00 00 20 | 00 - 64 | Level 1 | -50 - +50 |
| 00 00 21 | 00 - 64 | Time 2 | 0 - 100 |
| 00 00 22 | 00 - 64 | Time 3 | 0 - 100 |
| 00 00 23 | 00 - 64 | Level 2 | -50 - +50 |
| ----- | | | |
| < TVF > | | | |
| ----- | | | |
| 00 00 24 | 00 - 02 | Filter mode | HPF, BPF, LPF |
| 00 00 25 | 00 - 64 | Cutoff freq | 0 - 100 |
| 00 00 26 | 00 - 64 | Resonance | 0 - 100 |
| 00 00 27 | 00 - 28 | Key follow | -100 - 0 - +150(%) [*3] |
| 00 00 28 | 00 - 64 | A-touch sens | -50 - +50 |
| 00 00 29 | 00 - 01 | LFO select | LFO 1, LFO 2 |
| 00 00 2A | 00 - 64 | LFO depth | -50 - +50 |
| 00 00 2B | 00 - 64 | TVF ENV depth | -50 - +50 |
| ----- | | | |
| < TVF ENV > | | | |
| ----- | | | |
| 00 00 2C | 00 - 64 | Velo | -50 - +50 |
| 00 00 2D | 00 - 64 | Time velo | -50 - +50 |
| 00 00 2E | 00 - 14 | Time KF | -10 - +10 |
| 00 00 2F | 00 - 64 | Time 1 | 0 - 100 |
| 00 00 30 | 00 - 64 | Level 1 | 0 - 100 |
| 00 00 31 | 00 - 64 | Time 2 | 0 - 100 |
| 00 00 32 | 00 - 64 | Level 2 | 0 - 100 |
| 00 00 33 | 00 - 64 | Time 3 | 0 - 100 |
| 00 00 34 | 00 - 64 | Sustain level | 0 - 100 |
| 00 00 35 | 00 - 64 | Time 4 | 0 - 100 |
| 00 00 36 | 00 - 64 | Level 4 | 0 - 100 |
| ----- | | | |
| < TVA > | | | |
| ----- | | | |
| 00 00 37 | 00 - 02 | Bias direction | UP, LOW, U&L |
| 00 00 38 | 00 - 7F | Bias point | C-1 - G9 |
| 00 00 39 | 00 - 14 | Bias level | -10 - +10 |
| 00 00 3A | 00 - 64 | Level | 0 - 100 |
| 00 00 3B | 00 - 64 | A-touch sens | -50 - +50 |
| 00 00 3C | 00 - 01 | LFO select | LFO 1, LFO 2 |
| 00 00 3D | 00 - 64 | LFO depth | -50 - +50 |
| ----- | | | |
| < TVA ENV > | | | |
| ----- | | | |
| 00 00 3E | 00 - 64 | Velo | -50 - +50 |
| 00 00 3F | 00 - 64 | Time velo | -50 - +50 |
| 00 00 40 | 00 - 14 | Time KF | -10 - +10 |
| 00 00 41 | 00 - 64 | Time 1 | 0 - 100 |
| 00 00 42 | 00 - 64 | Level 1 | 0 - 100 |
| 00 00 43 | 00 - 64 | Time 2 | 0 - 100 |
| 00 00 44 | 00 - 64 | Level 2 | 0 - 100 |
| 00 00 45 | 00 - 64 | Time 3 | 0 - 100 |
| 00 00 46 | 00 - 64 | Sustain level | 0 - 100 |
| 00 00 47 | 00 - 64 | Time 4 | 0 - 100 |
| ----- | | | |
| Total size: 00 00 48 (72bytes) | | | |

[*1]:Only setting values within range 00H 00H (0) and 00H 6BH (107) can be used to generate sound of internal waveform.

When using a waveform card, the number of settings is limited up to the number of waveforms registered in the card minus 1. Otherwise, the tone is not sounded.

[*2]:-100, -50, -20, -10, -5, 0, +5, +10, +20, +50,

+98, +99, +100, +101, +102, +150, +200(%)

[*3]:-100 - 0%(10% step), 0 - +150%(5% step)

MIDI Implementation

/Application example of RQ1/

To derive all the tone B data within patch 1-12, transmit the following data to the JD-800.

```
FO 41 10 3D 11 05 04 08 00 00 48 27 F7
```

/Application example of DT1/

To set the cutoff frequency of part 2 patch temporary tone C to 100 during MULTI mode, transmit the following data to the JD-800.

```
FO 41 10 3D 12 00 14 39 64 4F F7
```

*4-6 Display Area

The data delivered to this area are interpreted as character string of ASCII code and placed on the left-hand LCD. The data request (RQ1) cannot be used to read the characters stored in this area. Character string cannot be displayed in the right-hand LCD.

| Offset | address | Data | Contents and remarks |
|--------|-------------------------------|---------|----------------------------|
| | 00 00 00 | 20 - 7F | Display Letter(1) (ASCII) |
| | : | : | : |
| | 00 00 2B | 20 - 7F | Display Letter(44) (ASCII) |
| | Total size 00 00 2C (44bytes) | | |

/Application example of DT1/

To have the JD-800 display show "Hello!", transmit the following data to the JD-800.

```
FO 41 10 3D 12 07 00 00 48 65 6C 6C 6F 21 64 F7
```

Address Map

| Address | Block | Sub Block | Reference |
|----------|---------------------------|---------------------|-----------|
| 00 00 00 | Single Patch Temp. Area | Patch Common | 4-5-1-1 |
| | | Patch Effect | 4-5-1-2 |
| | | Patch Tone-A | 4-5-1-3 |
| | | Patch Tone-B | 4-5-1-3 |
| | | Patch Tone-C | 4-5-1-3 |
| | | Patch Tone-D | 4-5-1-3 |
| 00 10 00 | Multi Patch Temp. Area | Part 1 Patch Common | 4-5-1-1 |
| | | Part 2 Patch Tone-A | 4-5-1-3 |
| | | Part 3 Patch Tone-B | 4-5-1-3 |
| | | Part 4 Patch Tone-C | 4-5-1-3 |
| | | Part 5 Patch Tone-D | 4-5-1-3 |
| 01 00 00 | Special Setup Temp. Area | Setup Common/EQ | 4-2-1 |
| | | C2 (#36) Setup Key | 4-2-2-1 |
| | | Key Tone | 4-5-1-3 |
| | | C7 (#96) | |
| 02 00 00 | System Area | | 4-3 |
| 03 00 00 | Part Area | Part 1 | 4-4-1 |
| | | Part 2 | 4-4-1 |
| | | Part 3 | 4-4-1 |
| | | Part 4 | 4-4-1 |
| | | Part 5 | 4-4-1 |
| | | Special Part | 4-4-2 |
| 04 00 00 | Special Setup Memory Area | Setup Common/EQ | 4-2-1 |
| | | C2 (#36) Setup Key | 4-2-2-1 |
| | | Key Tone | 4-5-1-3 |
| | | C7 (#96) | |
| 05 00 00 | Patch Memory Area | 1-11 Patch Common | 4-5-1-1 |
| | | 1-12 Patch Effect | 4-5-1-2 |
| | | Patch Tone-A | 4-5-1-3 |
| | | Patch Tone-B | 4-5-1-3 |
| | | Patch Tone-C | 4-5-1-3 |
| | | 1-88 Patch Tone-D | 4-5-1-3 |
| 07 00 00 | Display Area | | 4-6 |

MIDI Implementation Chart

| Function ... | | Transmitted | Recognized | Remarks |
|------------------|--|--|----------------------------------|-----------------------|
| Basic Channel | Default Changed | 1 - 16 each 1 - 16 each | 1 - 16 each 1 - 16 each | Memorized |
| Mode | Default Messages Altered | Mode 3 × ***** | Mode 3, 4 × | |
| Note Number | True Voice | 24 - 108 ***** | 0 - 127 0 - 127 | |
| Velocity | Note ON Note OFF | ○ v = 1 - 127 ○ v = 1 - 127 | ○ v = 1 - 127 * 3 v = 0 - 127 | |
| After Touch | Key's Ch's | × * 1 | × * 1 | |
| Pitch Bender | | ○ | ○ | 9 bit resolution |
| Control Change | 1 | ○ | ○ | Modulation |
| | 2 | × | * 1 | Breath |
| | 5 | × | ○ | Portamento time |
| | 38, 6 | × | ○ | Data Entry LSB, MSB |
| | 7 | * 1 | * 1 | Volume |
| | 10 | * 1 | × | Pan |
| | 64 | ○ | * 1 | Hold 1 |
| Control Change | 65 | × | ○ | Portamento |
| | 100, 101 | × | * 2 | PRN LSB, MSB |
| | 121 | ○ | ○ | Reset All Controllers |
| Prog Change | True # | * 1 ***** | * 1 0 - 127 | |
| System Exclusive | | ○ | * 1 | |
| System Common | Song Pos Song Sel Tune | × × × | × × × | |
| System Real Time | Clock Commands | × × | × × | |
| Aux Messages | Local ON/OFF All Notes OFF Active Sense Reset | × × ○ × | ○ ○ (123 - 127) ○ × | |
| Notes | | * 1 Changed to ○ or × manually, and memorized. * 2 RPN # 0 : Pitch Bend Sensitivity RPN # 1 : Fine Tune * 3 Used for retriger velocity in solo (Mode4). | | |

Mode 1 : OMNI ON, POLY
Mode 3 : OMNI OFF, POLY

Mode 2 : OMNI ON, MONO
Mode 4 : OMNI OFF, MONO

○ : Yes
× : No

MIDI Implementation Chart

| Function ... | | Transmitted | Recognized | Remarks |
|------------------|--|---|--|--|
| Basic Channel | Default Changed | 1 - 16 each 1 - 16 each | 1 - 16 each 1 - 16 each | Memorized |
| Mode | Default Messages Altered | Mode 3 × ***** | Mode 3, 4 × | |
| Note Number | True Voice | 24 - 108 ***** | 0 - 127 0 - 127 | |
| Velocity | Note ON Note OFF | ○ v = 1 - 127 ○ v = 1 - 127 | ○ v = 1 - 127 *3 v = 0 - 127 | |
| After Touch | Key's Ch's | × * 1 | × * 1 | |
| Pitch Bender | | ○ | ○ | 9 bit resolution |
| Control Change | | 1 ○ 2 × 5 × 38, 6 × 7 * 1 10 * 1 64 ○ 65 × 100, 101 × 121 ○ | ○ * 1 ○ ○ * 1 ○ * 1 ○ * 2 ○ | Modulation Breath Portamento time Data Entry LSB, MSB Volume Pan Hold 1 Portamento PRN LSB, MSB Reset All Controllers |
| Prog Change | True # | * 1 ***** | * 1 0 - 127 | |
| System Exclusive | | ○ | * 1 | |
| System Common | Song Pos Song Sel Tune | × × × | × × × | |
| System Real Time | Clock Commands | × × | × × | |
| Aux Messages | Local ON/OFF All Notes OFF Active Sense Reset | × × ○ × | ○ ○ (123 - 127) ○ × | |
| Notes | | * 1 Changed to ○ or × manually, and memorized. * 2 RPN # 0 : Pitch Bend Sensitivity RPN # 1 : Fine Tune * 3 Used for retrigger velocity in solo (Mode4). | | |

Mode 1 : OMNI ON, POLY
Mode 3 : OMNI OFF, POLY

Mode 2 : OMNI ON, MONO
Mode 4 : OMNI OFF, MONO

○ : Yes
× : No

MIDI Implementation Chart

| Function ... | | Transmitted | Recognized | Remarks |
|------------------|--|---|------------------------------|---|
| Basic Channel | Default Changed | 1 - 16 each 1 - 16 each | 1 - 16 each 1 - 16 each | Memorized |
| Mode | Default Messages Altered | Mode 3 OMNI OFF, POLY ***** | Mode 3 | |
| Note Number | True Voice | 24 - 108 ***** | 36 - 96 36 - 96 | |
| Velocity | Note ON Note OFF | ○ v = 1 - 127 ○ v = 1 - 127 | ○ v = 1 - 127 x | |
| After Touch | Key's Ch's | x * 1 | x * 1 | |
| Pitch Bender | | ○ | ○ | 9 bit resolution |
| Control Change | 1 | ○ | ○ | Modulation Breath Portamento time Data Entry LSB, MSB Volume Pan Hold 1 Portamento PRN LSB, MSB |
| | 2 | x | * 1 | |
| | 7 | | | |
| | 10 | x * 1 | ○ * 1 | |
| | 64 | * 1 ○ | x ○ | |
| | 100, 101 38, 6 | x | * 2 | |
| | 121 | ○ | ○ | Reset All Controllers |
| Prog Change | True # | * 1 ***** | * 1 0 - 1 | |
| System Exclusive | | ○ | * 1 | |
| System Common | Song Pos Song Sel Tune | x x x | x x x | |
| System Real Time | Clock Commands | x x | x x | |
| Aux Messages | Local ON/OFF All Notes OFF Active Sense Reset | x x ○ x | ○ ○ (123 - 127) ○ x | |
| Notes | | * 1 Changed to ○ or x manually, and memorized. * 2 RPN # 0 : Pitch Bend Sensitivity RPN # 1 : Fine Tune | | |

Mode 1 : OMNI ON, POLY
Mode 3 : OMNI OFF, POLY

Mode 2 : OMNI ON, MONO
Mode 4 : OMNI OFF, MONO

○ : Yes
x : No

Specifications

JD - 800 : PROGRAMMABLE SYNTHESIZER

○ Keyboard

Weighted-action 61 keys (with Velocity and Channel Aftertouch)

○ Maximum Polyphony
24 voices

○ Parts
Part 1 to 5, Special Part

○ Effects

Single Mode:

3 band EQ, Distortion, Phaser, Spectrum, Enhancer,
Chorus, Delay, Reverb, Mix Out Filter

Multi Mode:

3 band EQ, Reverb, Chorus + Reverb,
Delay + Reverb, Mix Out Filter

○ Memory

Internal (INT):

System setup 1
Patch 64
Special setup 1

DATA card (CARD):

System setup 1
Patch 64
Special setup 1

○ Display

LCD type:

22 characters, 2lines (backlit LCD) 1
16 characters, 2lines (backlit LCD) 1

LED type:

8 segments, 2 characters 1

○ Connectors

MIX OUT jacks (L, R)
DIRECT OUT jacks (L, R)
Headphone jack (Stereo)
MIDI Connectors (IN, OUT, THRU)
External Control jack
Hold Pedal jack

○ Power Supply

AC120V, AC230V, AC240V

○ Power Consumption

25 W (AC120V), 30 W (AC230V), 30 W (AC240V)

○ Dimensions

1040 (W) × 420 (D) × 108 (H) mm
40 - 15/16" × 16 - 9/16" × 4 - 1/4" inches

○ Weight

15.0 kg
33.1 lbs

○ Accessories

Owner's Manual User's Guide, Reference
Connection Cable (PJ - 1M) 1

○ Options

DATA card M - 256E
WAVEFORM card SO - JD80 series

***The specifications for this product are subject to change without prior notice.**

TOPICAL INDEX

The many parameters of the JD-800 are organized into several groups. But it is difficult to remember exactly what each parameter does.

This topical index will help you find the parameters related to what you wish to do. Refer to this index when you need help as you create your own sounds.

● Modify the sound

- Select Patches How to select a Patch (☞ P. I – 3, II – 4)
- Change the waveform Waveform (☞ P. I – 36)
- Modify the Filter settings Mode (☞ P. I – 51)
 - Cutoff Frequency (☞ P. I – 52)
 - Resonance (☞ P. I – 54)
- Modify the TVF envelope TVF ENV (☞ P. I – 60)
- Modify the effect of the TVF envelope
..... TVF ENV Depth (☞ P. I – 55)
- Make keyboard position affect the sound
..... Cutoff Key Follow (☞ P. I – 56)
 - TVF ENV Time Key Follow (☞ P. I – 63)
- Use velocity Velocity Curve (☞ P. I – 17)
 - TVF ENV Velocity (☞ P. I – 61)
 - TVF ENV Time Velocity (☞ P. I – 62)
- Use aftertouch Cutoff Aftertouch Sensitivity (☞ P. I – 59)
- Use the LFO LFO Select (☞ P. I – 57)
 - LFO Depth (☞ P. I – 58)
- Modify Equalizer settings EQ Setup (☞ P. I – 138)
- Modify the settings of Effect A Effect A Sequence (☞ P. I – 90)
(*only in Single mode)
 - Effect A Switch (☞ P. I – 91)
 - Distortion (☞ P. I – 95)
 - Enhancer (☞ P. I – 102)
 - Phaser (☞ P. I – 97)
 - Spectrum (☞ P. I – 100)
- Modify the settings of Effect B Effect B Sequence (☞ P. I – 92)
 - Effect B Switch (☞ P. I – 93)
 - Dry/Effect Balance B (☞ P. I – 94)
 - Chorus (☞ P. I – 104)
 - Delay (☞ P. I – 107)
 - Reverb (☞ P. I – 112)

● Modify the volume

- Modify the level of the Patch Patch Level (⇨ P. I – 119)
- Modify the level of the Part Part Level (⇨ P. II – 9)
- (*only in Multi mode)
- Modify the level of a Tone TVA Level (⇨ P. I – 67)
 - Palette sliders (⇨ P. I – 9)
- Modify the TVA envelope TVA ENV (⇨ P. I – 75)
- Make keyboard position affect the volume
 - Bias Direction (⇨ P. I – 68)
 - Bias Point (⇨ P. I – 70)
 - Bias Level (⇨ P. I – 71)
 - TVA ENV Time key follow (⇨ P. I – 78)
- Use velocity Velocity Curve (⇨ P. I – 17)
 - TVA ENV Velocity (⇨ P. I – 76)
 - TVA ENV Time Velocity (⇨ P. I – 77)
- Use aftertouch Level Aftertouch Sensitivity (⇨ P. I – 72)
- Use the LFO LFO Select (⇨ P. I – 73)
 - LFO Depth (⇨ P. I – 74)
- Use an expression pedal External control (⇨ P. III – 7)

● Modify the pitch

- Move the Bender lever Bender Switch (⇨ P. I – 34)
 - Bender Range (⇨ P. I – 122)
- Use aftertouch Aftertouch Bend Switch (⇨ P. I – 32)
 - Aftertouch Bend Sensitivity (⇨ P. I – 123)
- Change the basic pitch Pitch Coarse (⇨ P. I – 28)
 - Pitch Fine (⇨ P. I – 29)
 - Pitch Random (⇨ P. I – 30)
- Modify the pitch envelope PITCH ENV (⇨ P. I – 44)
- Make keyboard position affect the pitch
 - Pitch Key Follow (⇨ P. I – 31)
 - PITCH ENV Time Key Follow (⇨ P. I – 47)
- Use velocity PITCH ENV Velocity (⇨ P. I – 45)
 - PITCH ENV Time Velocity (⇨ P. I – 46)
- Use the LFO Lever Sensitivity (⇨ P. I – 43)
 - Aftertouch Modulation Sensitivity (⇨ P. I – 39)
 - LFO1 Depth (⇨ P. I – 41)
 - LFO2 Depth (⇨ P. I – 42)
- Use Portamento Portamento Switch (⇨ P. I – 126)
 - Portamento Mode (⇨ P. I – 127)
 - Portamento Time (⇨ P. I – 128)
- Use Transpose Transpose Switch (⇨ P. III – 5)
 - Transpose Value (⇨ P. III – 6)

● Thicken the sound

- Layer Tones Layer (☞ P. I – 129)
- Set Key Range Key Range A/B/C/D (☞ P. I – 120)
- Skew the pitch Pitch Fine (☞ P. I – 29)
 - Pitch Random (☞ P. I – 30)
- Modify Effect B settings Effect B Sequence (☞ P. I – 92)
 - Effect B Switch (☞ P. I – 93)
 - Chorus (☞ P. I – 104)
 - Delay (☞ P. I – 107)
 - Reverb (☞ P. I – 112)

● Turn each effect on/off

- Make Effect Master Switch settings
 - Chorus/Delay/Reverb Switch (☞ P. III – 9)
- Make Effect Switch settings Effect A Switch (☞ P. I – 91)
 - (*only in Single mode) Effect B Switch (☞ P. I – 93)
- Set effect parameters for the Part Output Assign (☞ P. II – 11)
 - (*only in Multi mode) Effect Mode (☞ P. II – 12)
 - Effect Level (☞ P. II – 13)

● Make effect settings

- Make Patch effect settings Effect Edit (☞ P. I – 88)
 - (only in Single mode)
- Make Multi effect settings Effect Edit (☞ P. II – 31)
 - (only in Multi mode)

● Sustain the sound

- Use a Hold pedal Hold Control (☞ P. I – 15)
- Make TVA envelope settings TVA Envelope (☞ P. I – 75)

● Play monophonically

- Use Solo mode Solo Switch (☞ P. I – 124)
 - Solo Legato (☞ P. I – 125)
- Use Portamento Portamento Switch (☞ P. I – 126)
 - Portamento Mode (☞ P. I – 127)
 - Portamento Time (☞ P. I – 128)

● Transpose

- Use Transpose Transpose Switch (⇨ P. III – 5)
Transpose Value (⇨ P. III – 6)
- Make Pitch Coarse settings Pitch Coarse (⇨ P. I – 28)

● Modify panning (stereo position)

- Use an expression pedal External Control (⇨ P. III – 7)
(*only in Multi mode)
- Make Pan settings for each Part Pan (⇨ P. II – 10)
(*only in Multi mode)

● Tune to other instruments

- Set Master Tune Master Tune (⇨ P. III – 4)

● Transfer external memory data

- Initialize a Data card Card Initialize (⇨ P. IV – 2)
- Save to a Data card Card Save (⇨ P. IV – 4)
- Select from a Data card Select a Patch (⇨ P. I – 3, II – 4)
Select a Setup (⇨ P. II – 4)
Card Load (⇨ P. IV – 6)
- Exchange internal and card data Exchange (⇨ P. IV – 8)
- Restore the factory preset data Factory Preset (⇨ P. IV – 14)

● Control external sound sources

- Match the MIDI channels MIDI transmit channel (⇨ P. III – 13)
Patch transmit MIDI Channel (⇨ P. I – 135)
- Make Local Control settings Local Control (⇨ P. III – 11)
- MIDI transmit settings for data
..... Program Change transmission (⇨ P. III – 16)
Aftertouch transmission (⇨ P. III – 19)
- MIDI transmit settings for Patches Key Mode (⇨ P. I – 132)
Split Point (⇨ P. I – 134)
L/U Channel (⇨ P. I – 135)
L/U Program Change (⇨ P. I – 136)
Hold Mode (⇨ P. I – 137)

● Play the internal sound source from an external device

- Match the MIDI channels.....MIDI Receive channel (☞ P. III – 15)
(*only in Single mode)
- Match the MIDI channels..... Part MIDI Receive channel (☞ P. II – 8)
(*only in Multi mode)
- Specify MIDI data reception.....Program Change reception (☞ P. III – 18)
 - Aftertouch reception (☞ P. III – 20)
 - Volume reception (☞ P. III – 21)
 - Breath Control reception (☞ P. III – 22)

● Transmit exclusive data

- Match the Unit numbersUnit Number (☞ P. III – 12)
- Transmit Patch data.....Patch Dump (☞ P. IV – 10)
- Transmit bulk data..... Bulk Dump (☞ P. IV – 12)
- Specify transmission of currently edited Tone data
.....Edit Data transmission (☞ P. III – 24)

● Receive exclusive data

- Match the unit numbersUnit Number (☞ P. III – 12)
- Specify reception of exclusive dataExclusive Data reception (☞ P. III – 23)

INDEX

【A】

Active I -6, I -130
Aftertouch Bend Sensitivity I -123
Aftertouch Bend Switch I -32
Aftertouch Cutoff Sensitivity I -59
Aftertouch Level Sensitivity I -72
Aftertouch Modulation Sensitivity I -39
Aftertouch Reception III -20
Aftertouch Transmission III -19

【B】

Band 1 — 6 Control I -101
Band Width I -101
Bandpass Filter I -51
Bender Range I -122
Bender Switch I -34
Bias Direction I -68
Bias Level I -71
Bias Point I -70
Blank Chart V -46
Breath Reception III -22
Bulk Dump IV -12

【C】

Card Initialize IV -2
Card Load IV -6
Card Save IV -4
Chorus I -104
Center Level I -108
Center tap I -108
Common (Patch) I -117
Common (Special setup) II -24
Common (Tone) I -15
Current Part II -3
Cutoff Frequency I -52
Cutoff Keyfollow I -56

【D】

DATA Card I -3, II -4
Data Transfer IV -1
Delay I -107
Delay (Chorus) I -105

Delay (LFO) I -21
Depth (Chorus) I -105
Depth (Phaser) I -98
Detune I -11, I -29
DIRECT OUT Jack II -11
Distortion I -95
Drive I -96
Dry/Effects Balance B I -94

【E】

Early Reflection Level I -115
Edit data Transmission III -24
Effects (Single) I -88
Effects (Muiti) II -31
Effect Level (Key setup) II -22
Effect Level (Part) II -13
Effect Master Switch III -9
Effect mode (Key setup) II -21
Effect mode (Part) II -12
Enhancer I -102
Envelope Mode II -19
EQ I -138
Error messages V -29
Exclusive Reception III -23
Exchange IV -8
External Control III -7

【F】

Factory Preset IV -14
Fade I -22
Feedback (Chorus) I -106
Feedback (Delay) I -110
Filter mode I -51

【H】

HF Damp I -115
High Frequency I -142
High Gain I -143
High pass Filter I -51
Hold Mode I -137
Hold Control I -15

【K】

Key Mode I-132
 Key Range I-120
 Key Setup II-15
 Key Setup Copy II-30
 Key Trigger I-26

【L】

Layer I-5, I-129
 Left Level I-109
 Left tap I-108
 Lever Modulation Sensitivity I-43
 Level (Chorus) I-106
 Level (Distortion) I-96
 Level (Part) II-9
 Level (Reverb) I-116
 Level (TVA) I-67
 Level (TVA ENV) I-79
 Level (TVF ENV) I-64
 Level (Pitch ENV) I-48
 LFO 1/2 I-19
 LFO Modulation Depth (TVA) I-74
 LFO Modulation Depth (TVF) I-58
 LFO Modulation Select (TVA) I-73
 LFO Modulation Select (TVF) I-57
 LFO 1 Modulation Depth I-41
 LFO 2 Modulation Depth I-42
 Local Control III-11
 Low Frequency I-140
 Low Gain I-140
 Low Pass Filter I-51

【M】

Manual I-12
 Manual (Phaser) I-98
 Master Tune III-4
 Memory 11
 Mid Frequency I-141
 Mid Gain I-142
 Mid Q I-141
 MIDI Transmit Channel III-13
 MIDI Transmit Channel (Patch) I-135
 MIDI Receive Channel (Multi mode) III-15
 MIDI Receive Channel (Single mode) II-8

MIDI Implementation V-53
 MIDI Implementation Chart V-65
 Multi Mode 13, II-2
 Mute Group II-17
 Mix (Enhancer) I-103
 Mix (Phaser) I-99
 Mix out Filter III-8

【O】

Offset I-25
 Original Value I-8
 Output Assign (Part) II-11

【P】

Palette I-9
 Pan (Key setup) II-20
 Pan (Part) II-10
 Parameter List V-37
 Parameter View I-7
 Part II-3
 Part Edit II-6
 Patch 9, I-81
 Patch Copy I-86, I-87
 Patch Compare I-84
 Patch Damp IV-10
 Patch Edit I-81
 Patch Name I-118
 Patch Write I-83
 Patch Level I-119
 Phaser I-97
 Pitch Course I-28
 Pitch Envelope I-44
 Pitch Fine I-29
 Pitch Key Follow I-31
 Pitch Random I-30
 Portamento Switch I-126
 Portamento Mode I-127
 Portamento Time I-128
 Pre Delay Time I-114
 Program Change Number I-2, II-3
 Program Change Number (Patch) I-136
 Program Change Reception III-18
 Program Change Transmission III-16

【R】

Rate (Chorus) I -105
 Rate (LFO) I -20
 Rate (Phaser) I -98
 Resonance (Phaser) I -99
 Resonance (TVF) I -54
 Reverb I -112
 Right Level I -109
 Right tap I -109
 ROM Play V -28

【S】

Sens I -103
 Sequence A I -90
 Sequence B I -92
 Single mode 12, I -2
 Solo Switch I -124
 Solo Legato I -125
 Source (WG) I -38
 Special Setup 10, II -14
 Special Setup Write II -28
 Spectrum I -100
 Split Point I -134
 Switch A I -91
 Switch B I -93

【T】

Temporary 11, I -3, II -14
 Time (Pitch ENV) I -49
 Time (TVA ENV) I -80
 Time (TVF ENV) I -65
 Time (Reverb) I -116
 Time Key Follow (Pitch ENV) I -47
 Time Key Follow (TVA ENV) I -78
 Time Key Follow (TVF ENV) I -63
 Time Velocity (Pitch ENV) I -46
 Time Velocity (TVA ENV) I -77
 Time Velocity (TVF ENV) I -62
 Tone 9, I -4
 Tone Copy I -10
 Tone Edit I -14
 Tone Name II -18
 Tone Parameter I -2

Transpose Switch III -5
 Transpose Value III -6
 Tremolo I -20, I -73, I -74
 Troubleshooting V -31
 TVA I -66
 TVA Envelope I -75
 TVF I -50
 TVF Envelope I -60
 TVF Envelope Depth I -55
 Type (Distortion) I -96
 Type (Reverb) I -114

【U】

Unit Number III -12

【V】

Velocity Crossfade I -18
 Velocity Curve I -17
 Velocity Sensitivity (Pitch ENV) I -45
 Velocity Sensitivity (TVA ENV) I -76
 Velocity Sensitivity (TVF ENV) I -61
 Vibrato I -20
 Volume Reception III -21

【W】

Waveform (LFO) I -24
 Waveform (WG) I -36
 Waveform Card I -38
 Waveform List V -34
 Wah Wah I -20, I -57, I -58
 WG I -27

【MEMO】

JD-800

— Patch List —



| |
|------------------------------|
| Patch Number |
| Patch Name Layer settings |

* This list indicates the settings of Factory Preset Patches (Patch names and Layer settings).
* 工場出荷時のパッチの設定です。パッチ・ネームとレイヤーの状態を示しています。

| Electronic Music | Analog Synthesizer | Keyboard | Bass & Solo | Guitar & Clavi | Layered Sound | Pad | Ethnic Pipe, Bell, etc. |
|-------------------------|-------------------------|--------------------------|--------------------------|-------------------------|--------------------------|-------------------------|-------------------------|
| I - 11 | I - 12 | I - 13 | I - 14 | I - 15 | I - 16 | I - 17 | I - 18 |
| Millennium ABCD | Massive Pad ABCD | Crystal Rhodes -BCD | Synthadelic Bass ABCD | Wailing Guitar ABC- | Fantasia 90's ABCD | Spun Glass ABCD | Mother Afrika! ABCD |
| I - 21 | I - 22 | I - 23 | I - 24 | I - 25 | I - 26 | I - 27 | I - 28 |
| Swimotion ABCD | Classic Sweeper ABCD | LA MIDI'ed Piano AB-- | Meaty Bass ABCD | Stratomaster ABCD | Perc - Vox Stack A*CD | Killer Pad ABCD | Waveblower ABC- |
| I - 31 | I - 32 | I - 33 | I - 34 | I - 35 | I - 36 | I - 37 | I - 38 |
| Sci - Fi Groove ABCD | Mr. Brass! ABCD | Bruiser Tines ABC* | Wet Bass ABC* | Throaty Clav A*CD | Rockin' Wire ABC* | Iceman ABCD | Ming Dynasty A*CD |
| I - 41 | I - 42 | I - 43 | I - 44 | I - 45 | I - 46 | I - 47 | I - 48 |
| Planetarium ABCD | Pulse Pad ABC- | All Stops Out ABCD | Fusion Solo ABCD | MIDI Guitar ABCD | Pain&Injury Keyz ABCD | Deep Breath Pad ABCD | Harlequin ABCD |
| I - 51 | I - 52 | I - 53 | I - 54 | I - 55 | I - 56 | I - 57 | I - 58 |
| Hearts of Space ABC* | Analog Brass *BC* | Ac. Piano 1 A*C* | Modular Bass ABC- | Clavinut A*CD | Vocostat ABCD | Invocation ABCD | Ethnic Logs AB*D |
| I - 61 | I - 62 | I - 63 | I - 64 | I - 65 | I - 66 | I - 67 | I - 68 |
| 2 - way Slide ABC* | Macho Swell ABCD | Sunday Best ABCD | Synth Pipe Solo AB*D | Nylon Choir A**D | Scraping Bone ABCD | Hybrid Strings *BCD | JD - bells 1 ABCD |
| I - 71 | I - 72 | I - 73 | I - 74 | I - 75 | I - 76 | I - 77 | I - 78 |
| 1974! A*CD | Polysynth AB** | Metallic Rhodes ABC* | Face Bass A*CD | Velo - Crunch ABC- | Stack Attack! ABCD | Girlish Vox ABC* | Shakufute ABCD |
| I - 81 | I - 82 | I - 83 | I - 84 | I - 85 | I - 86 | I - 87 | I - 88 |
| Aurora Borealis ABCD | Pulsation A*C* | Waveola Keys ABC- | Tekno Funk Bass ABC- | Backwards *60's A*C- | Chinkvox/Bass ABCD | Bottle It AB-- | Doo Pipes ABC- |

※ "*" のトーンはレイヤー・オンにすると、パッチの音色が変わります。
※ "-" はレイヤー・オフのトーンを示します。
※ "▼" はアクティブ・オンのトーンを示します。

* Tones indicated by an asterisk (*) change the tone color of the Patch when the corresponding layer is turned on.
* "-" indicates Tones whose layer is turned off.
* "▼" indicates Tones whose Active is turned on.

JD-800 — Setup List —



| | Note number | Tone name | Mute group | ENV mode | Pan | EFF mode | EFF level |
|----|-------------|------------|------------|----------|-----------|-----------|-----------|
| C2 | 36 | Kick A | OFF | NO SUS | 00 | DRY | 50 |
| | 37 | Kick B | OFF | NO SUS | 00 | DRY | 50 |
| | 38 | Snare A | OFF | NO SUS | 01R | REV | 100 |
| | 39 | Block | OFF | NO SUS | 00 | REV | 100 |
| | 40 | Snare B | OFF | NO SUS | 00 | REV | 100 |
| | 41 | Tom 1 | OFF | NO SUS | L25 | CHO + REV | 80 |
| | 42 | Closed HH | A | NO SUS | 20R | REV | 50 |
| | 43 | Tom 2 | OFF | NO SUS | L10 | CHO + REV | 80 |
| | 44 | 1/2 Closed | A | NO SUS | 20R | REV | 40 |
| | 45 | Tom 3 | OFF | NO SUS | 10R | CHO + REV | 80 |
| C3 | 46 | Open HH | A | NO SUS | 20R | REV | 40 |
| | 47 | Tom 4 | OFF | NO SUS | 20R | CHO + REV | 80 |
| | 48 | Switch | OFF | NO SUS | L19 | REV | 100 |
| | 49 | Resoklang | OFF | NO SUS | 03R | REV | 100 |
| | 50 | Cowbell | OFF | NO SUS | 03R | REV | 100 |
| | 51 | Small Bell | OFF | NO SUS | L30 | CHO + REV | 100 |
| | 52 | Log Drum | OFF | NO SUS | L19 | REV | 100 |
| | 53 | Syndrum 1 | B | NO SUS | L20 | CHO + REV | 50 |
| | 54 | Hi Agogo | OFF | NO SUS | L19 | REV | 100 |
| | 55 | Syndrum 2 | C | NO SUS | 00 | CHO + REV | 50 |
| C4 | 56 | Lo Agogo | OFF | NO SUS | 19R | REV | 100 |
| | 57 | Syndrum 3 | D | NO SUS | 20R | CHO + REV | 50 |
| | 58 | Rando 1 | OFF | NO SUS | L08 | REV | 65 |
| | 59 | Cymbal A | E | NO SUS | L30 | CHO + REV | 100 |
| | 60 | Cymbal B | F | NO SUS | L30 | CHO + REV | 100 |
| | 61 | Cymbal C | G | NO SUS | L30 | CHO + REV | 100 |
| | 62 | Syn Clap | OFF | NO SUS | 12R | REV | 100 |
| | 63 | Wood Crack | OFF | NO SUS | L20 | DLY + REV | 100 |
| | 64 | Long Guiro | OFF | NO SUS | L06 | REV | 100 |
| | 65 | Shrt Guiro | OFF | NO SUS | L06 | REV | 100 |
| C5 | 66 | Tambourin | OFF | NO SUS | L20 | REV | 100 |
| | 67 | Wind Chime | OFF | NO SUS | L12 | DLY + REV | 100 |
| | 68 | Anklungs | OFF | NO SUS | 15R | DLY + REV | 100 |
| | 69 | Gong | OFF | NO SUS | 00 | CHO + REV | 100 |
| | 70 | Pole | OFF | NO SUS | 00 | CHO + REV | 100 |
| | 71 | Shaker | OFF | NO SUS | L25 | REV | 55 |
| | 72 | Ooops | OFF | NO SUS | L25 | CHO + REV | 55 |
| | 73 | Bottle Hit | OFF | NO SUS | 20R | DLY + REV | 100 |
| | 74 | Laser II | OFF | NO SUS | L15 | CHO + REV | 100 |
| | 75 | Typewriter | OFF | NO SUS | 12R | REV | 100 |
| C6 | 76 | Dropper | OFF | NO SUS | 02R | DLY + REV | 100 |
| | 77 | Conga Mute | OFF | NO SUS | 00 | REV | 80 |
| | 78 | Conga Hi | OFF | NO SUS | 10R | REV | 80 |
| | 79 | Conga Low | OFF | NO SUS | L10 | REV | 80 |
| | 80 | Tom 5 | OFF | NO SUS | L25 | CHO + REV | 100 |
| | 81 | Rattler | OFF | NO SUS | 15R | CHO + REV | 100 |
| | 82 | Rando 2 | OFF | NO SUS | 08R | CHO + REV | 100 |
| | 83 | Kick C | OFF | NO SUS | 00 | DRY | 100 |
| | 84 | Vari - Vox | OFF | SUS | L20 | DLY + REV | 100 |
| | 85 | Vari - Vox | OFF | SUS | 20R | DLY + REV | 100 |
| C7 | 86 | Vari - Vox | OFF | SUS | L10 | DLY + REV | 100 |
| | 87 | Vari - Vox | OFF | SUS | 10R | DLY + REV | 100 |
| | 88 | Vari - Vox | OFF | SUS | L30 | DLY + REV | 100 |
| | 89 | Vari - Vox | OFF | SUS | 30R | DLY + REV | 100 |
| | 90 | Vari - Vox | OFF | SUS | L05 | DLY + REV | 100 |
| | 91 | Vari - Vox | OFF | SUS | 05R | DLY + REV | 100 |
| | 92 | Vari - Vox | OFF | SUS | L15 | DLY + REV | 100 |
| | 93 | Vari - Vox | OFF | SUS | 15R | DLY + REV | 100 |
| | 94 | Vari - Vox | OFF | SUS | L20 | DLY + REV | 100 |
| | 95 | Vari - Vox | OFF | SUS | 20R | DLY + REV | 100 |
| 96 | Vari - Vox | OFF | SUS | 00 | DLY + REV | 100 | |

Roland®

26045448

UPC

26045448



18981